

**Installation for Dodge Challenger, Charger, HellCat & 392
PN's-140642, 140646, 140647, 140648, 140666, 140667, 140668, 140669
140639, 140640, 140641, 140670, 140671, 140672, 140673, 140674,
140675, 140676, 140677, 140678**



******* Please compare the parts in the box with the bill of materials provided *****
to assure that you have all the parts necessary for this installation.**

These instructions have been written to help you with the installation of your Borla Performance Exhaust System. Please read this document completely before beginning the installation of your system.

To ensure this part number fits your specific model year, please visit our website for the latest model year listings at www.BORLA.com

Thank you for purchasing a Borla Performance Cat-Back™ Exhaust System.

Borla Performance Cat-Back™ Exhaust Systems (PN's-140642, 140646, 140647, 140648, 140666, 140667, 140668, 140669) are designed for the Dodge Challenger & Charger HELLCAT equipped with 6.2L Supercharged V-8 engine, RWD, automatic or transmissions.

Borla Performance Cat-Back™ Exhaust Systems (PN's-140639, 140640, 140641, 140670, 140671, 140672, 140673, 140674, 140675, 140676, 140677, 140678) are designed for the Dodge Challenger & Charger 392 equipped with 6.4L V-8 engine, RWD, automatic or manual transmissions.

Borla Performance Industries recommends that an exhaust shop or professional after market parts installer, who has all the necessary equipment, tools and experienced personnel needed for proper installation, should perform the installation of this system. However, if you decide to perform the installation, we recommend someone should help you. Ensure the installer uses all under car safety precautions including eye protection.

Please take time to read and understand the following...

By installing your Borla Performance Exhaust System, you indicate that you have read this document and you agree with the terms stated below.

It is the responsibility of the purchaser to follow all installation instruction guidelines and safety procedures supplied with your Borla Performance Exhaust System.

Borla Performance Industries assumes no responsibility for damages occurring from misuse, abuse, improper installation, improper operation, lack of responsible care, or all previously stated reasons resulting from incompatibility with other manufacturer's products and/or systems.

Included with your Borla Performance Exhaust System is a warranty card. Please read it carefully before you begin any work on your vehicle. If you should have any questions regarding our warranty policy, installation, or any other matter pertaining to your new Borla Performance Exhaust System, please give us a call at the number provided on the warranty card.

Minimum Required Tool List:

TOOLS:

1. 3/8" Drive Ratchet
2. 3/8" Drive Extension 3"
3. 15mm Socket
4. 13mm Socket
5. Philips Screwdriver
6. Flat Small Screwdriver
7. Pry Bar

SHOP SUPPLIES:

- 1 Spray Lubricant

Borla Performance Cat-back™ Bill of Materials

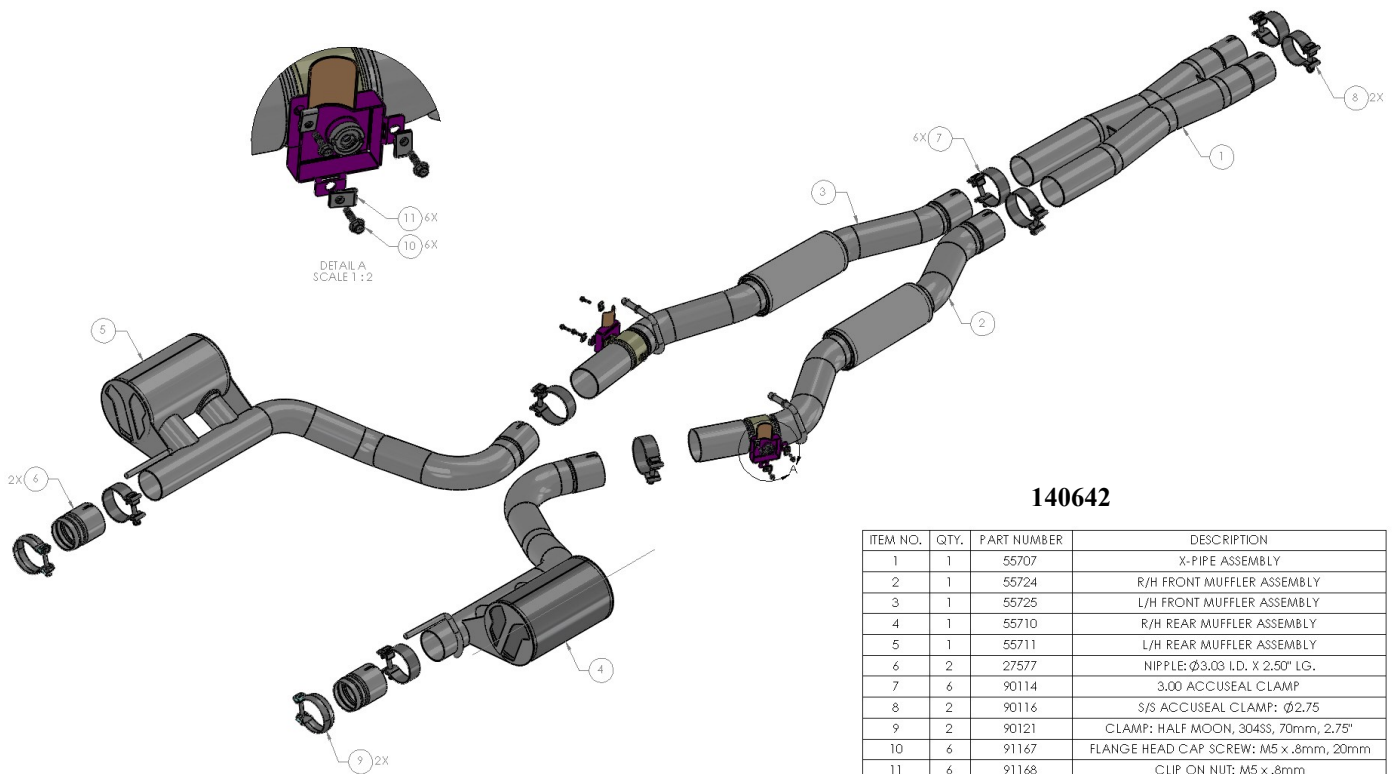

140642

ITEM NO.	QTY.	PART NUMBER	DESCRIPTION
1	1	55707	X-PIPE ASSEMBLY
2	1	55724	R/H FRONT MUFFLER ASSEMBLY
3	1	55725	L/H FRONT MUFFLER ASSEMBLY
4	1	55710	R/H REAR MUFFLER ASSEMBLY
5	1	55711	L/H REAR MUFFLER ASSEMBLY
6	2	27577	NIPPLE: Ø3.03 I.D. X 2.50" LG.
7	6	90114	3.00 ACCUSEAL CLAMP
8	2	90116	S/S ACCUSEAL CLAMP: Ø2.75
9	2	90121	CLAMP: HALF MOON, 304SS, 70mm, 2.75"
10	6	91167	FLANGE HEAD CAP SCREW: M5 x .8mm, 20mm
11	6	91168	CLIP ON NUT: M5 x .8mm

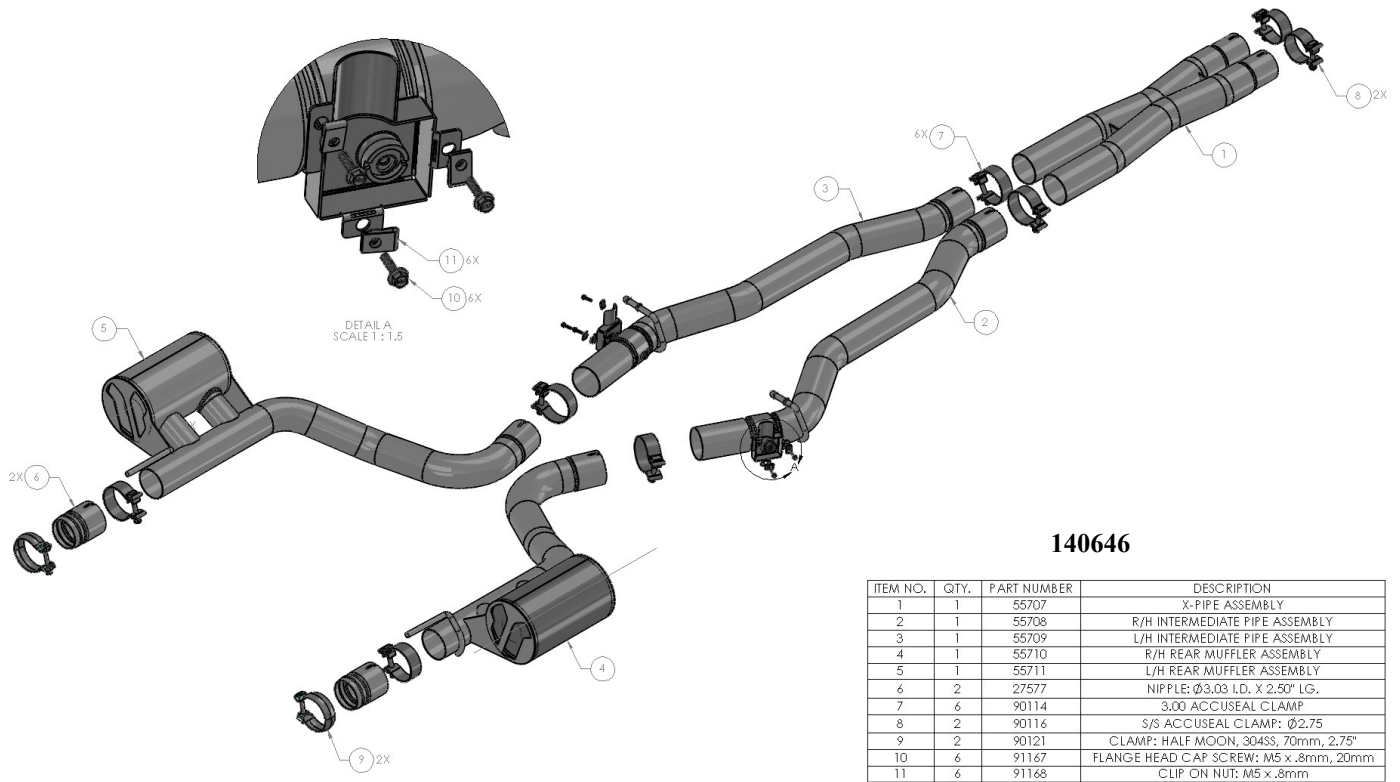

140646

ITEM NO.	QTY.	PART NUMBER	DESCRIPTION
1	1	55707	X-PIPE ASSEMBLY
2	1	55708	R/H INTERMEDIATE PIPE ASSEMBLY
3	1	55709	L/H INTERMEDIATE PIPE ASSEMBLY
4	1	55710	R/H REAR MUFFLER ASSEMBLY
5	1	55711	L/H REAR MUFFLER ASSEMBLY
6	2	27577	NIPPLE: Ø3.03 I.D. X 2.50" LG.
7	6	90114	3.00 ACCUSEAL CLAMP
8	2	90116	S/S ACCUSEAL CLAMP: Ø2.75
9	2	90121	CLAMP: HALF MOON, 304SS, 70mm, 2.75"
10	6	91167	FLANGE HEAD CAP SCREW: M5 x .8mm, 20mm
11	6	91168	CLIP ON NUT: M5 x .8mm

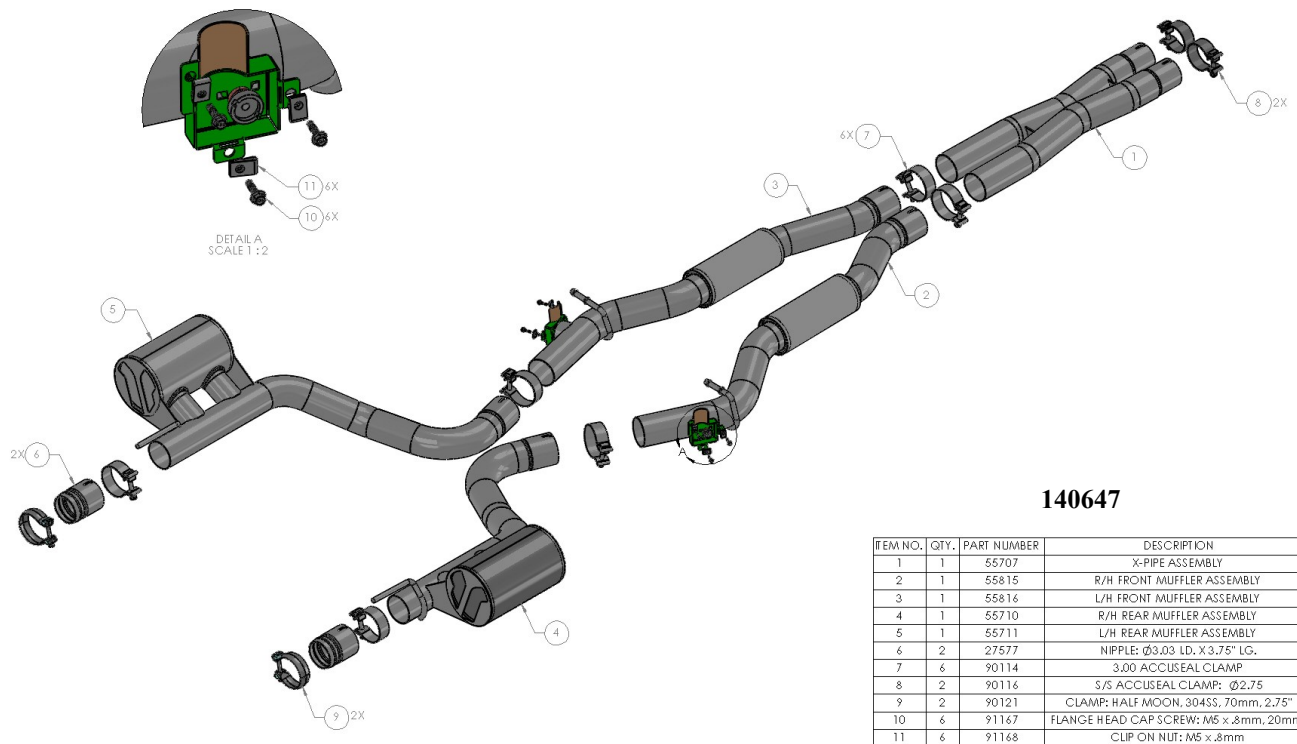

140647

ITEM NO.	QTY.	PART NUMBER	DESCRIPTION
1	1	55707	X-PIPE ASSEMBLY
2	1	55815	R/H FRONT MUFFLER ASSEMBLY
3	1	55816	L/H FRONT MUFFLER ASSEMBLY
4	1	55710	R/H REAR MUFFLER ASSEMBLY
5	1	55711	L/H REAR MUFFLER ASSEMBLY
6	2	27577	NIPPLE: Ø3.03 I.D. X 3.75" LG.
7	6	90114	3.00 ACCUSEAL CLAMP
8	2	90116	S/S ACCUSEAL CLAMP: Ø2.75
9	2	90121	CLAMP: HALF MOON, 304SS, 70mm, 2.75"
10	6	91167	FLANGE HEAD CAP SCREW: M5 x .8mm, 20mm
11	6	91168	CLIP ON NUT: M5 x .8mm

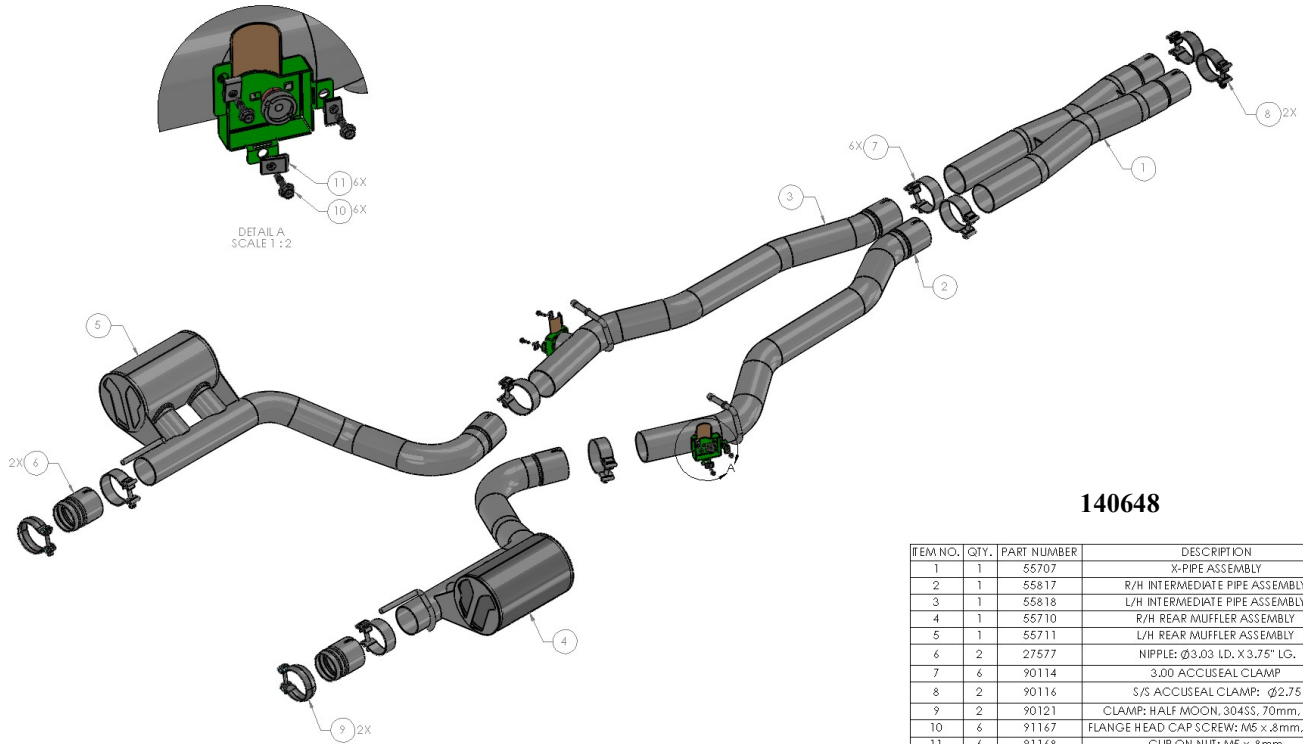

140648

ITEM NO.	QTY.	PART NUMBER	DESCRIPTION
1	1	55707	X-PIPE ASSEMBLY
2	1	55817	R/H INTERMEDIATE PIPE ASSEMBLY
3	1	55818	L/H INTERMEDIATE PIPE ASSEMBLY
4	1	55710	R/H REAR MUFFLER ASSEMBLY
5	1	55711	L/H REAR MUFFLER ASSEMBLY
6	2	27577	NIPPLE: $\varnothing 3.03$ I.D. X 3.75" LG.
7	6	90114	3.00 ACCUSEAL CLAMP
8	2	90116	S/S ACCUSEAL CLAMP: $\varnothing 2.75$
9	2	90121	CLAMP: HALF MOON, 304SS, 70mm, 2.75"
10	6	91167	FLANGE HEAD CAP SCREW: M5 x .8mm, 20mm
11	6	91168	CLIP ON NUT: M5 x .8mm

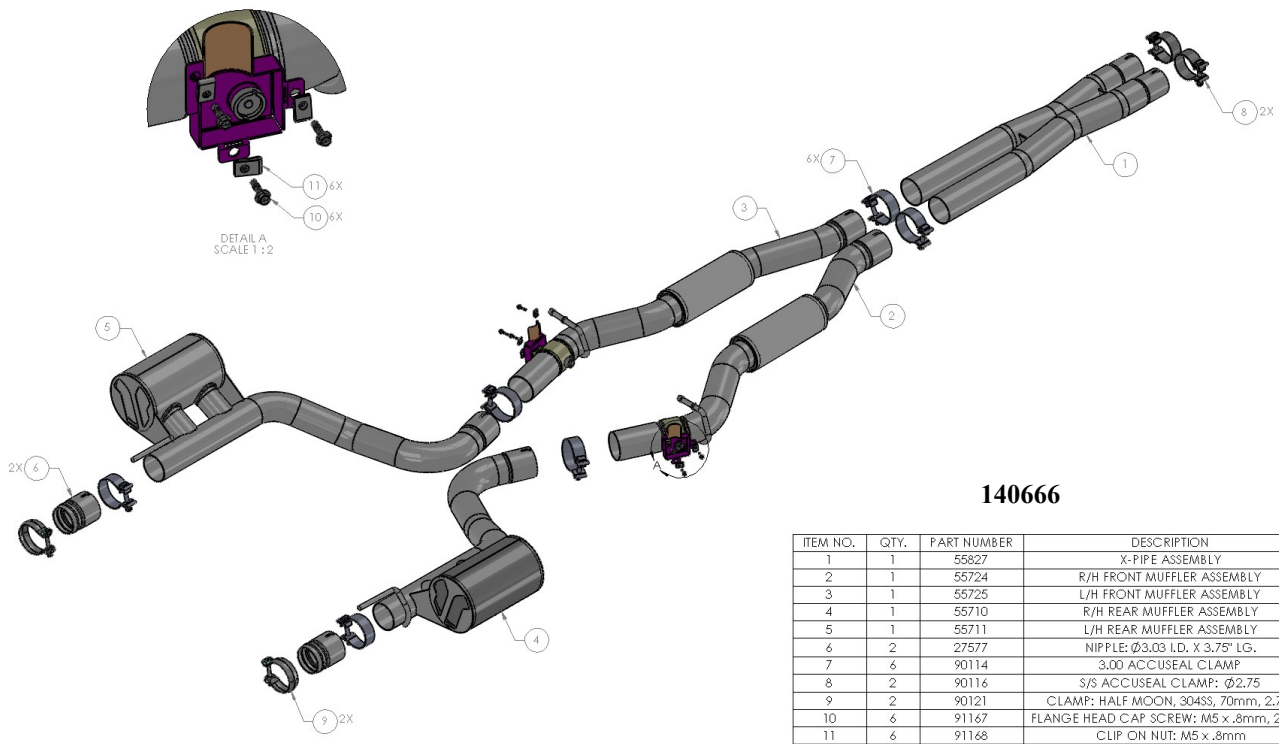

140666

ITEM NO.	QTY.	PART NUMBER	DESCRIPTION
1	1	55827	X-PIPE ASSEMBLY
2	1	55724	R/H FRONT MUFFLER ASSEMBLY
3	1	55725	L/H FRONT MUFFLER ASSEMBLY
4	1	55710	R/H REAR MUFFLER ASSEMBLY
5	1	55711	L/H REAR MUFFLER ASSEMBLY
6	2	27577	NIPPLE: $\varnothing 3.03$ I.D. X 3.75" LG.
7	6	90114	3.00 ACCUSEAL CLAMP
8	2	90116	S/S ACCUSEAL CLAMP: $\varnothing 2.75$
9	2	90121	CLAMP: HALF MOON, 304SS, 70mm, 2.75"
10	6	91167	FLANGE HEAD CAP SCREW: M5 x .8mm, 20mm
11	6	91168	CLIP ON NUT: M5 x .8mm

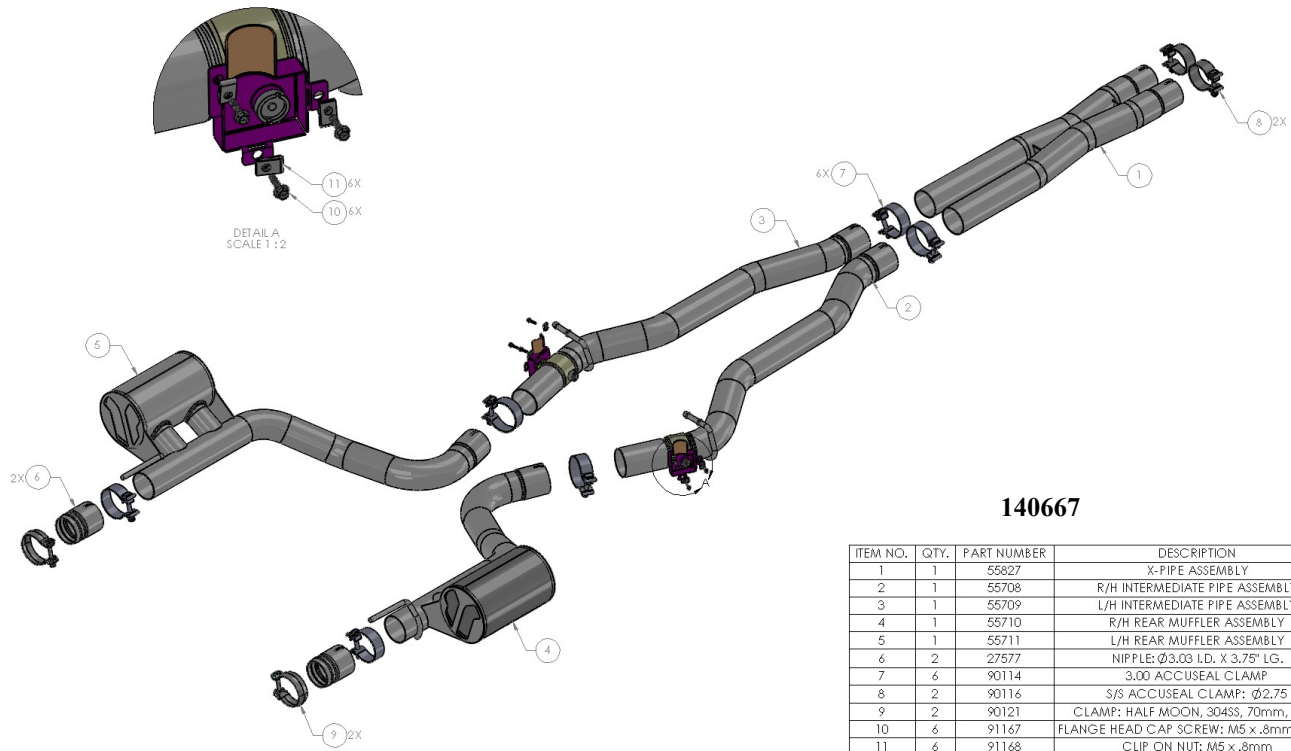

140667

ITEM NO.	QTY.	PART NUMBER	DESCRIPTION
1	1	55827	X-PIPE ASSEMBLY
2	1	55708	R/H INTERMEDIATE PIPE ASSEMBLY
3	1	55709	L/H INTERMEDIATE PIPE ASSEMBLY
4	1	55710	R/H REAR MUFFLER ASSEMBLY
5	1	55711	L/H REAR MUFFLER ASSEMBLY
6	2	27577	NIPPLE: Ø3.03 I.D. X 3.75" LG.
7	6	90114	3.00 ACCUSEAL CLAMP
8	2	90116	S/S ACCUSEAL CLAMP: Ø2.75
9	2	90121	CLAMP: HALF MOON, 304SS, 70mm, 2.75"
10	6	91167	FLANGE HEAD CAP SCREW: M5 x .8mm, 20mm
11	6	91168	CLIP ON NUT: M5 x .8mm

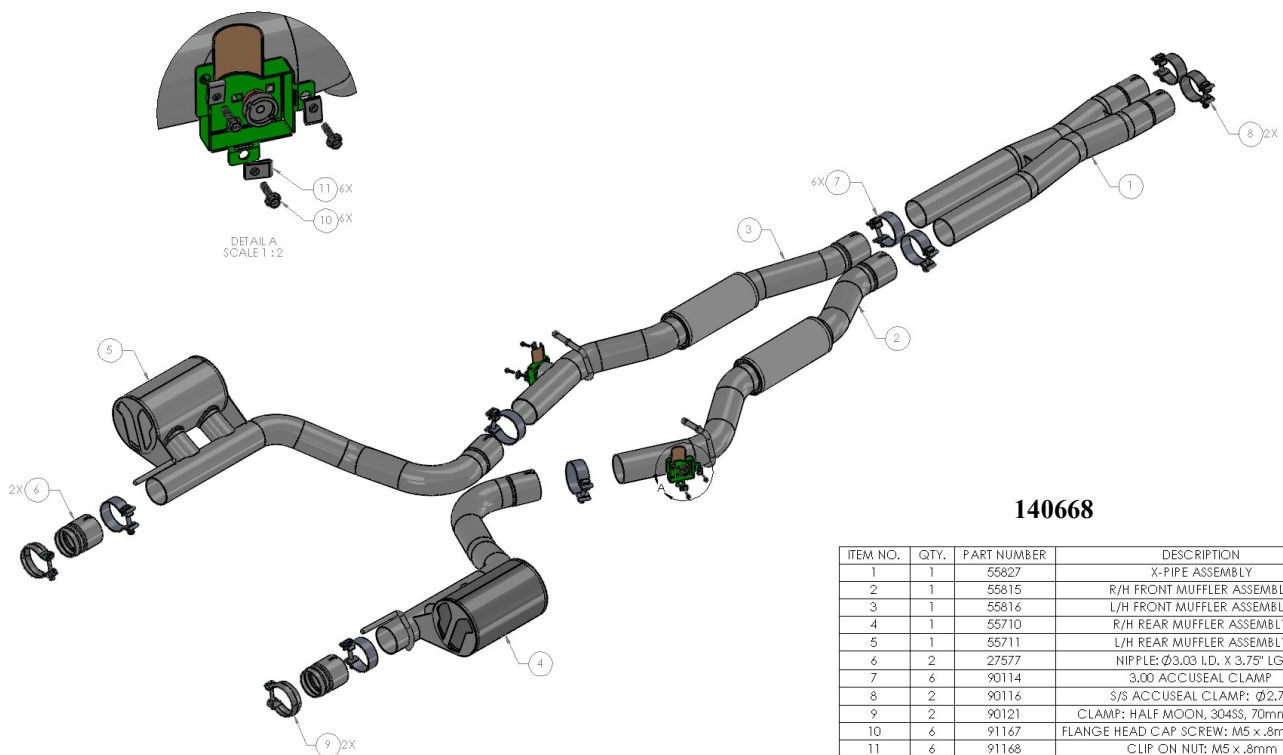

140668

ITEM NO.	QTY.	PART NUMBER	DESCRIPTION
1	1	55827	X-PIPE ASSEMBLY
2	1	55815	R/H FRONT MUFFLER ASSEMBLY
3	1	55816	L/H FRONT MUFFLER ASSEMBLY
4	1	55710	R/H REAR MUFFLER ASSEMBLY
5	1	55711	L/H REAR MUFFLER ASSEMBLY
6	2	27577	NIPPLE: Ø3.03 I.D. X 3.75" LG.
7	6	90114	3.00 ACCUSEAL CLAMP
8	2	90116	S/S ACCUSEAL CLAMP: Ø2.75
9	2	90121	CLAMP: HALF MOON, 304SS, 70mm, 2.75"
10	6	91167	FLANGE HEAD CAP SCREW: M5 x .8mm, 20mm
11	6	91168	CLIP ON NUT: M5 x .8mm

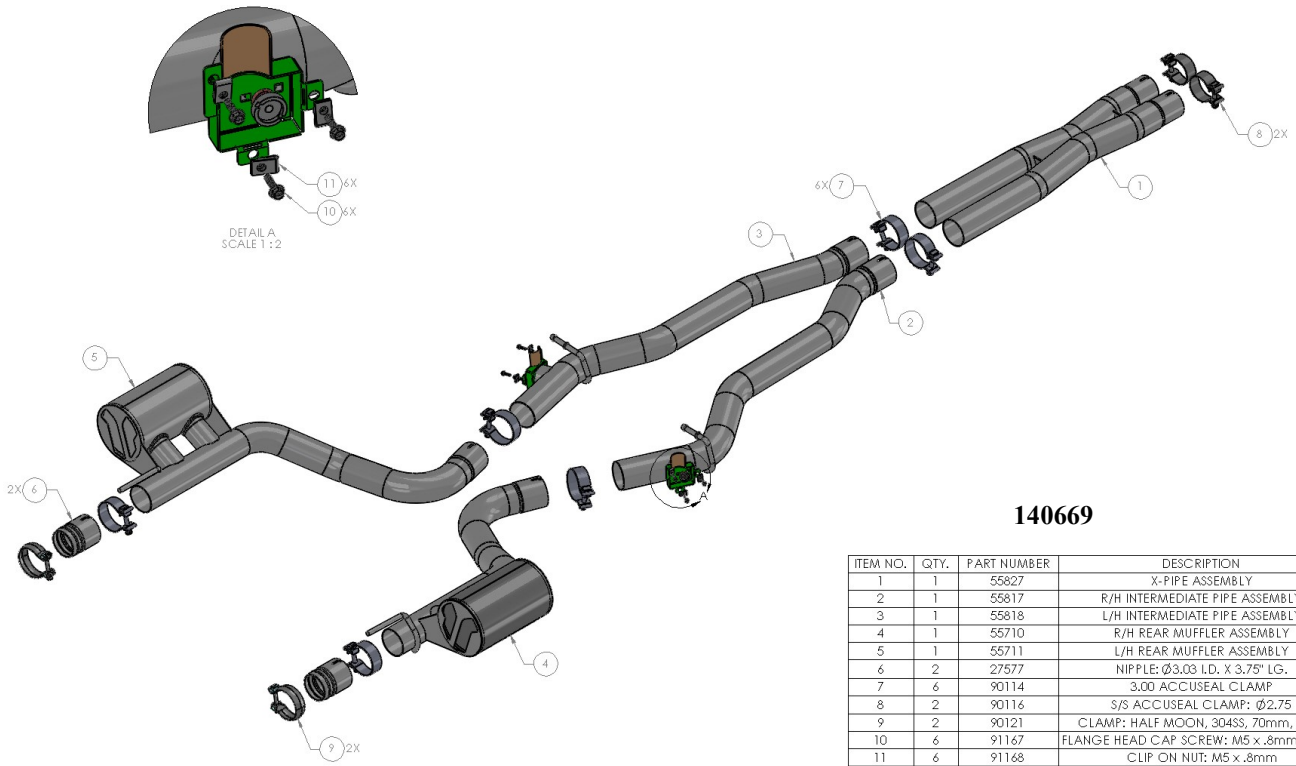

140669

ITEM NO.	QTY.	PART NUMBER	DESCRIPTION
1	1	55827	X-PIPE ASSEMBLY
2	1	55817	R/H INTERMEDIATE PIPE ASSEMBLY
3	1	55818	L/H INTERMEDIATE PIPE ASSEMBLY
4	1	55710	R/H REAR MUFFLER ASSEMBLY
5	1	55711	L/H REAR MUFFLER ASSEMBLY
6	2	27577	NIPPLE: Ø3.03 I.D. X 3.75" LG.
7	6	90114	3.00 ACCUSEAL CLAMP
8	2	90116	S/S ACCUSEAL CLAMP: Ø2.75
9	2	90121	CLAMP: HALF MOON, 304SS, 70mm, 2.75"
10	6	91167	FLANGE HEAD CAP SCREW: M5 x .8mm, 20mm
11	6	91168	CLIP ON NUT: M5 x .8mm

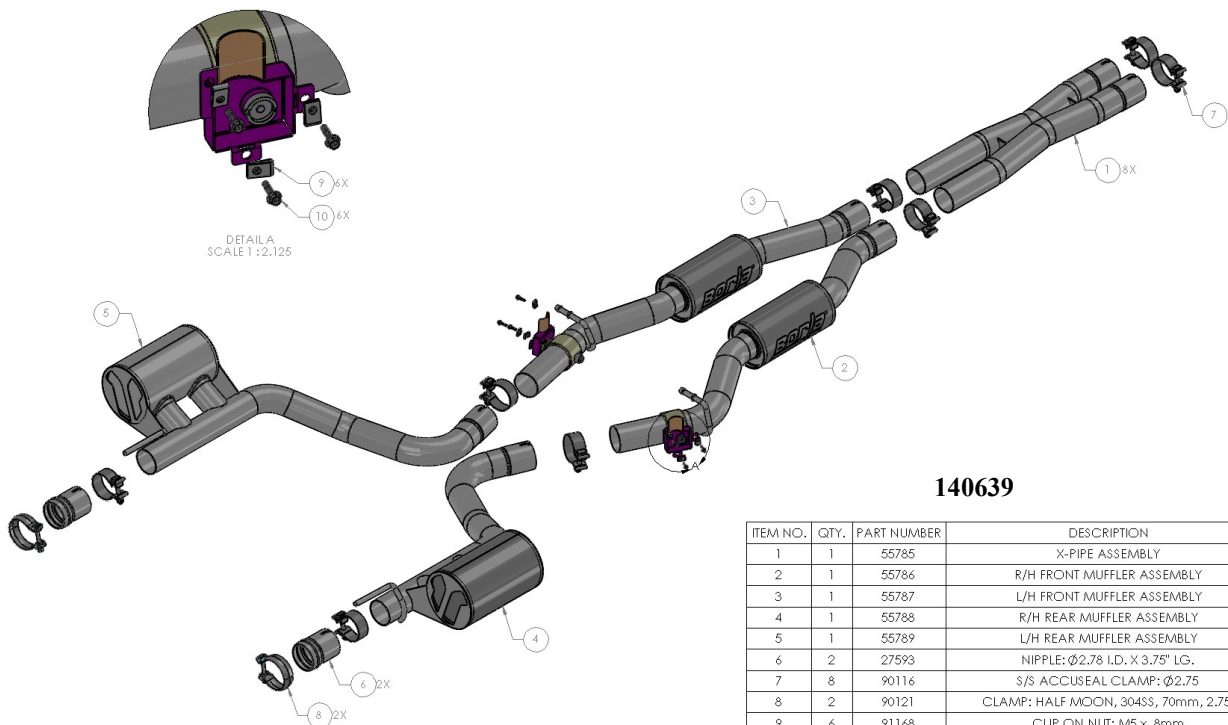

140639

ITEM NO.	QTY.	PART NUMBER	DESCRIPTION
1	1	55785	X-PIPE ASSEMBLY
2	1	55786	R/H FRONT MUFFLER ASSEMBLY
3	1	55787	L/H FRONT MUFFLER ASSEMBLY
4	1	55788	R/H REAR MUFFLER ASSEMBLY
5	1	55789	L/H REAR MUFFLER ASSEMBLY
6	2	27593	NIPPLE: Ø2.78 I.D. X 3.75" LG.
7	8	90116	S/S ACCUSEAL CLAMP: Ø2.75
8	2	90121	CLAMP: HALF MOON, 304SS, 70mm, 2.75"
9	6	91168	CLIP ON NUT: M5 x .8mm
10	6	91167	FLANGE HEAD CAP SCREW: M5 x .8mm, 20mm

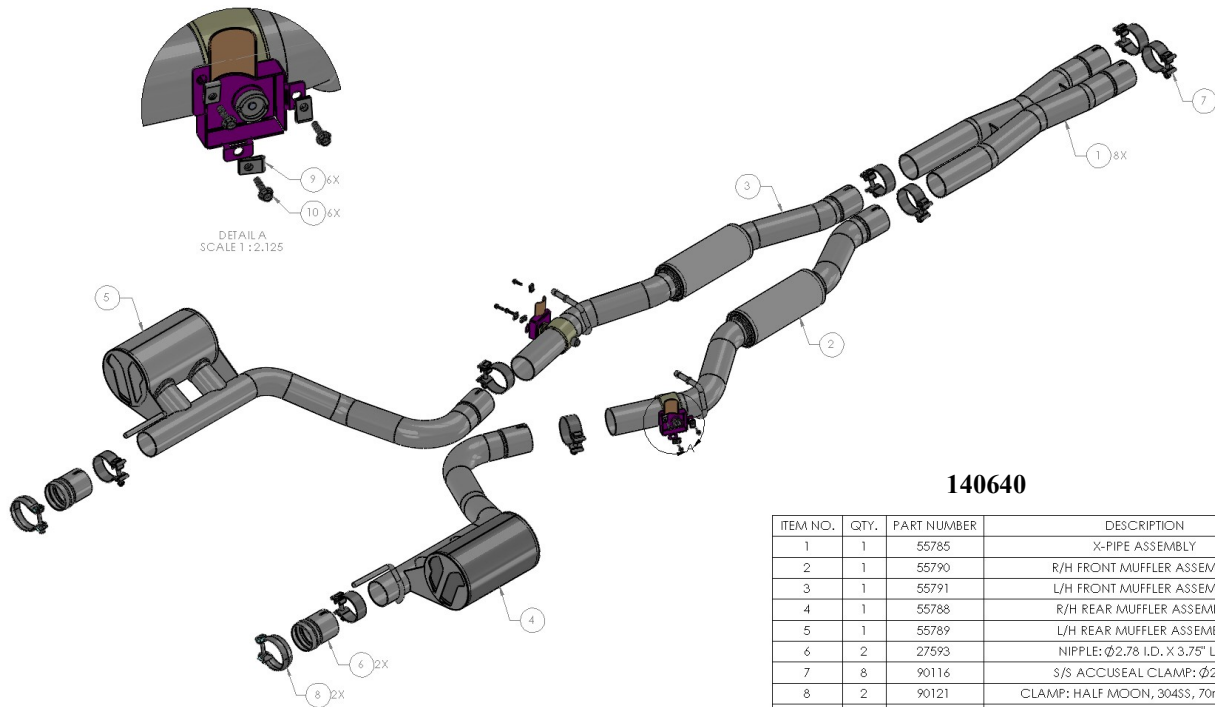

140640

ITEM NO.	QTY.	PART NUMBER	DESCRIPTION
1	1	55785	X-PIPE ASSEMBLY
2	1	55790	R/H FRONT MUFFLER ASSEMBLY
3	1	55791	L/H FRONT MUFFLER ASSEMBLY
4	1	55788	R/H REAR MUFFLER ASSEMBLY
5	1	55789	L/H REAR MUFFLER ASSEMBLY
6	2	27593	NIPPLE: Ø2.78 I.D. X 3.75" LG.
7	8	90116	S/S ACCUSEAL CLAMP: Ø2.75
8	2	90121	CLAMP: HALF MOON, 304SS, 70mm, 2.75"
9	6	91168	CLIP ON NUT: M5 x .8mm
10	6	91167	FLANGE HEAD CAP SCREW: M5 x .8mm, 20mm

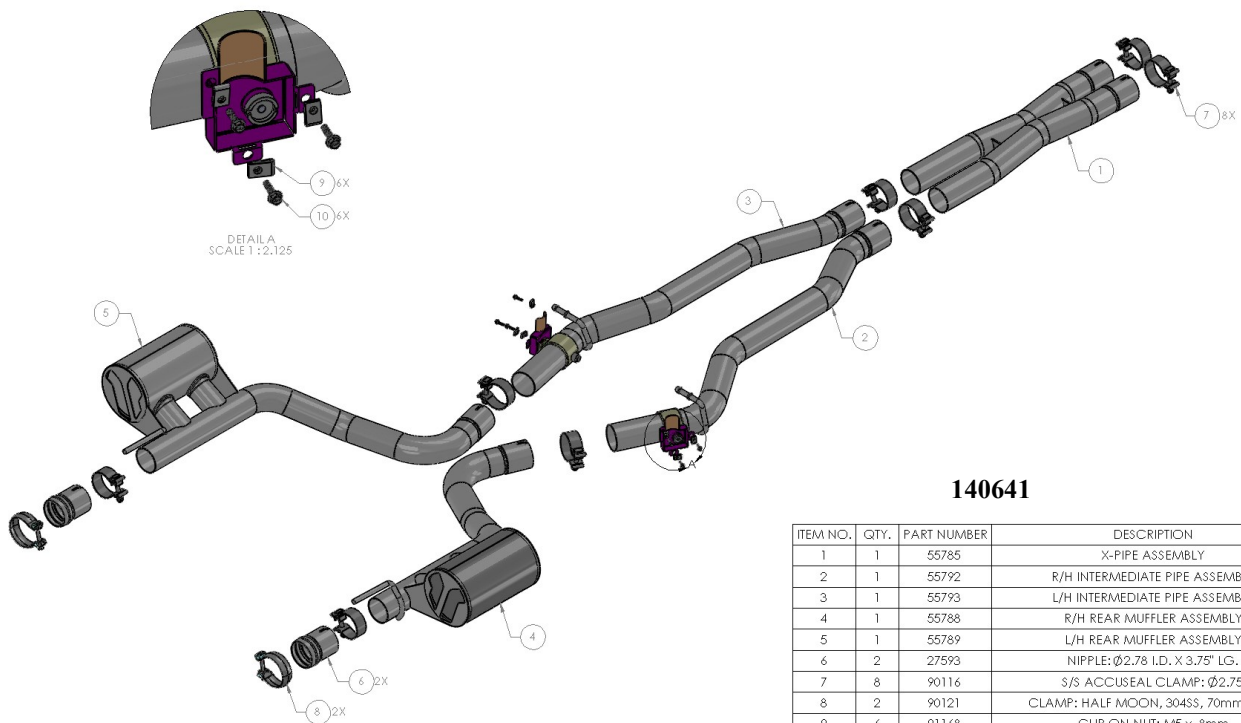

140641

ITEM NO.	QTY.	PART NUMBER	DESCRIPTION
1	1	55785	X-PIPE ASSEMBLY
2	1	55792	R/H INTERMEDIATE PIPE ASSEMBLY
3	1	55793	L/H INTERMEDIATE PIPE ASSEMBLY
4	1	55788	R/H REAR MUFFLER ASSEMBLY
5	1	55789	L/H REAR MUFFLER ASSEMBLY
6	2	27593	NIPPLE: Ø2.78 I.D. X 3.75" LG.
7	8	90116	S/S ACCUSEAL CLAMP: Ø2.75
8	2	90121	CLAMP: HALF MOON, 304SS, 70mm, 2.75"
9	6	91168	CLIP ON NUT: M5 x .8mm
10	6	91167	FLANGE HEAD CAP SCREW: M5 x .8mm, 20mm

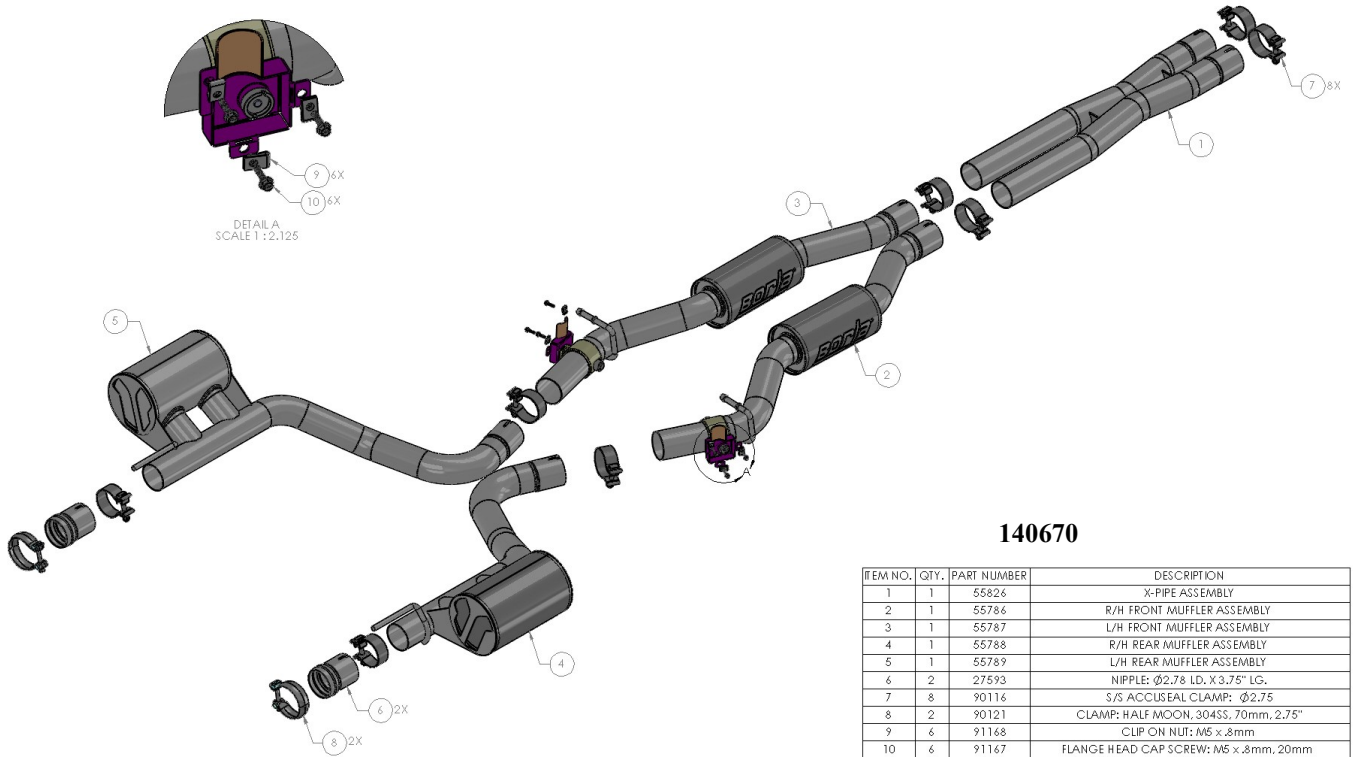

140670

ITEM NO.	QTY.	PART NUMBER	DESCRIPTION
1	1	55826	X-PIPE ASSEMBLY
2	1	55786	R/H FRONT MUFFLER ASSEMBLY
3	1	55787	L/H FRONT MUFFLER ASSEMBLY
4	1	55788	R/H REAR MUFFLER ASSEMBLY
5	1	55789	L/H REAR MUFFLER ASSEMBLY
6	2	27593	NIPPLE: Ø2.78 LD. X 3.75" LG.
7	8	90116	S/S ACCUSEAL CLAMP: Ø2.75
8	2	90121	CLAMP: HALF MOON, 304SS, 70mm, 2.75"
9	6	91168	CLIP ON NUT: M5 x .8mm
10	6	91167	FLANGE HEAD CAP SCREW: M5 x .8mm, 20mm

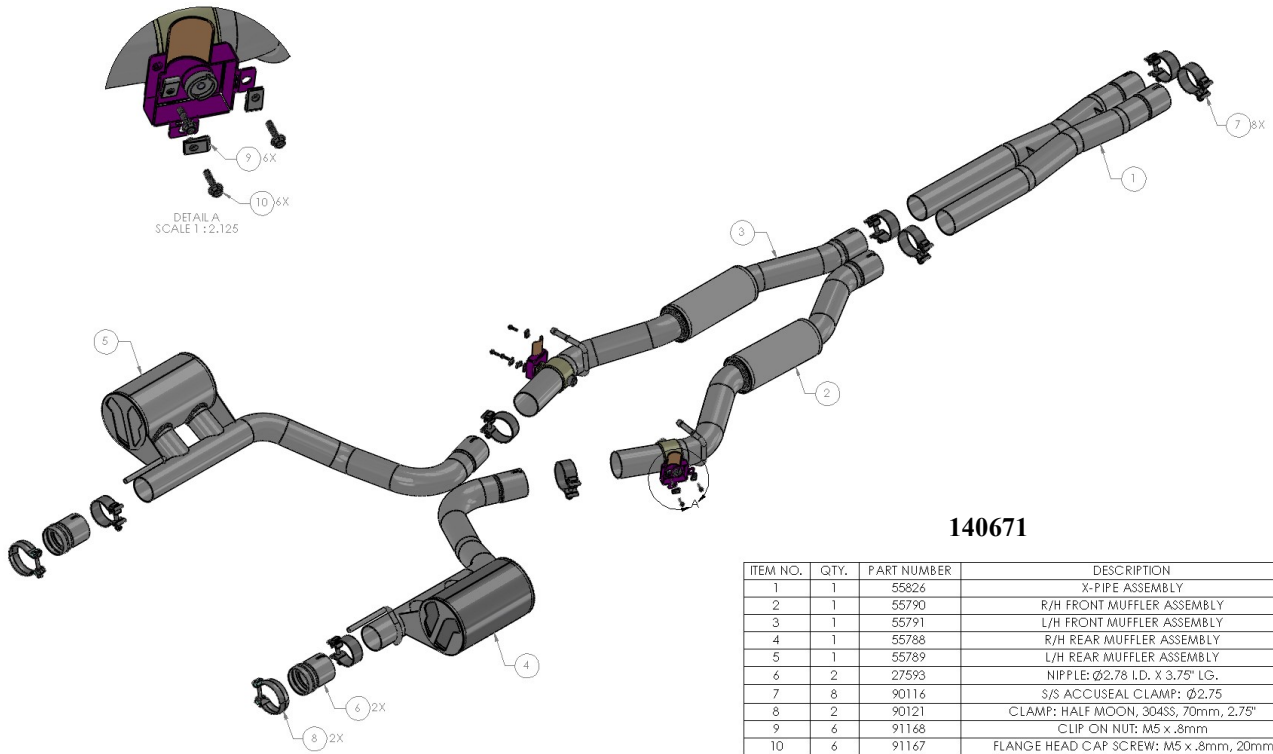

140671

ITEM NO.	QTY.	PART NUMBER	DESCRIPTION
1	1	55826	X-PIPE ASSEMBLY
2	1	55790	R/H FRONT MUFFLER ASSEMBLY
3	1	55791	L/H FRONT MUFFLER ASSEMBLY
4	1	55788	R/H REAR MUFFLER ASSEMBLY
5	1	55789	L/H REAR MUFFLER ASSEMBLY
6	2	27593	NIPPLE: Ø2.78 I.D. X 3.75" LG.
7	8	90116	S/S ACCUSEAL CLAMP: Ø2.75
8	2	90121	CLAMP: HALF MOON, 304SS, 70mm, 2.75"
9	6	91168	CLIP ON NUT: M5 x .8mm
10	6	91167	FLANGE HEAD CAP SCREW: M5 x .8mm, 20mm

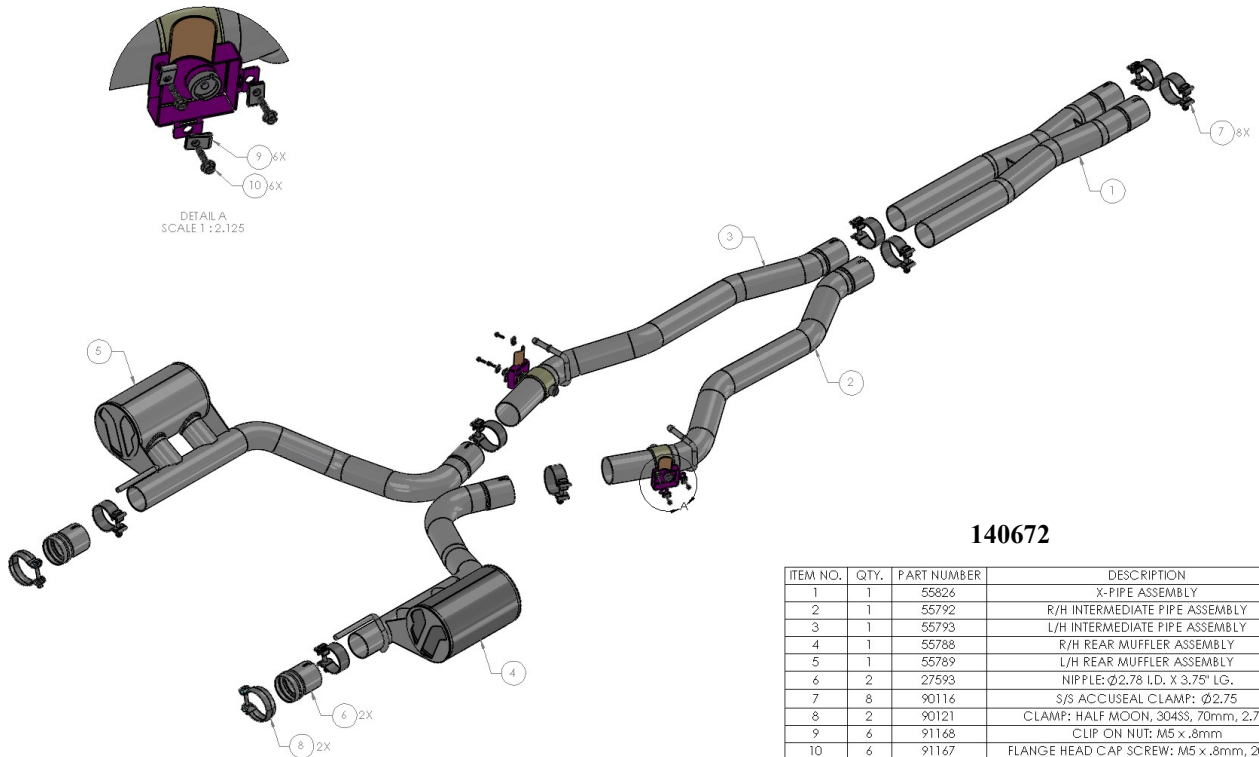

140672

ITEM NO.	QTY.	PART NUMBER	DESCRIPTION
1	1	55826	X-PIPE ASSEMBLY
2	1	55792	R/H INTERMEDIATE PIPE ASSEMBLY
3	1	55793	L/H INTERMEDIATE PIPE ASSEMBLY
4	1	55788	R/H REAR MUFFLER ASSEMBLY
5	1	55789	L/H REAR MUFFLER ASSEMBLY
6	2	27593	NIPPLE: Ø2.78 I.D. X 3.75" LG.
7	8	90116	S/S ACCUSEAL CLAMP: Ø2.75
8	2	90121	CLAMP: HALF MOON, 304SS, 70mm, 2.75"
9	6	91168	CLIP ON NUT: M5 x .8mm
10	6	91167	FLANGE HEAD CAP SCREW: M5 x .8mm, 20mm

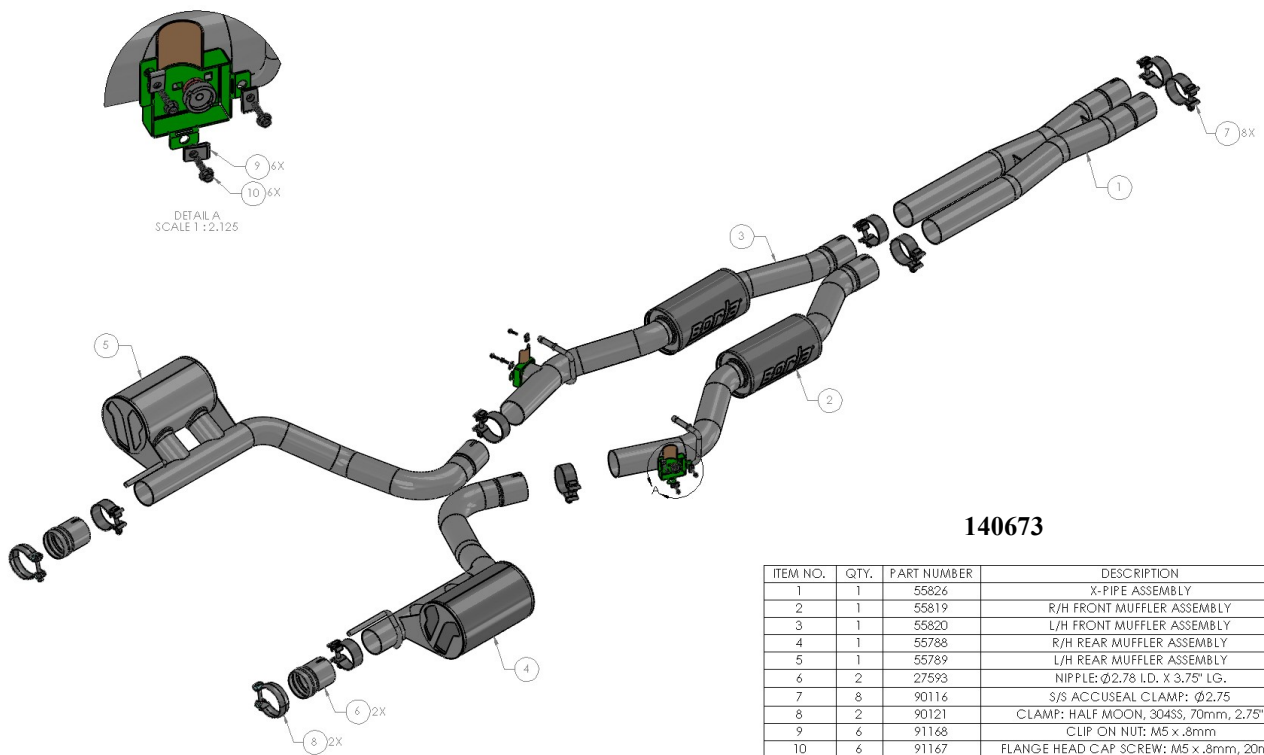

140673

ITEM NO.	QTY.	PART NUMBER	DESCRIPTION
1	1	55826	X-PIPE ASSEMBLY
2	1	55819	R/H FRONT MUFFLER ASSEMBLY
3	1	55820	L/H FRONT MUFFLER ASSEMBLY
4	1	55788	R/H REAR MUFFLER ASSEMBLY
5	1	55789	L/H REAR MUFFLER ASSEMBLY
6	2	27593	NIPPLE: Ø2.78 I.D. X 3.75" LG.
7	8	90116	S/S ACCUSEAL CLAMP: Ø2.75
8	2	90121	CLAMP: HALF MOON, 304SS, 70mm, 2.75"
9	6	91168	CLIP ON NUT: M5 x .8mm
10	6	91167	FLANGE HEAD CAP SCREW: M5 x .8mm, 20mm

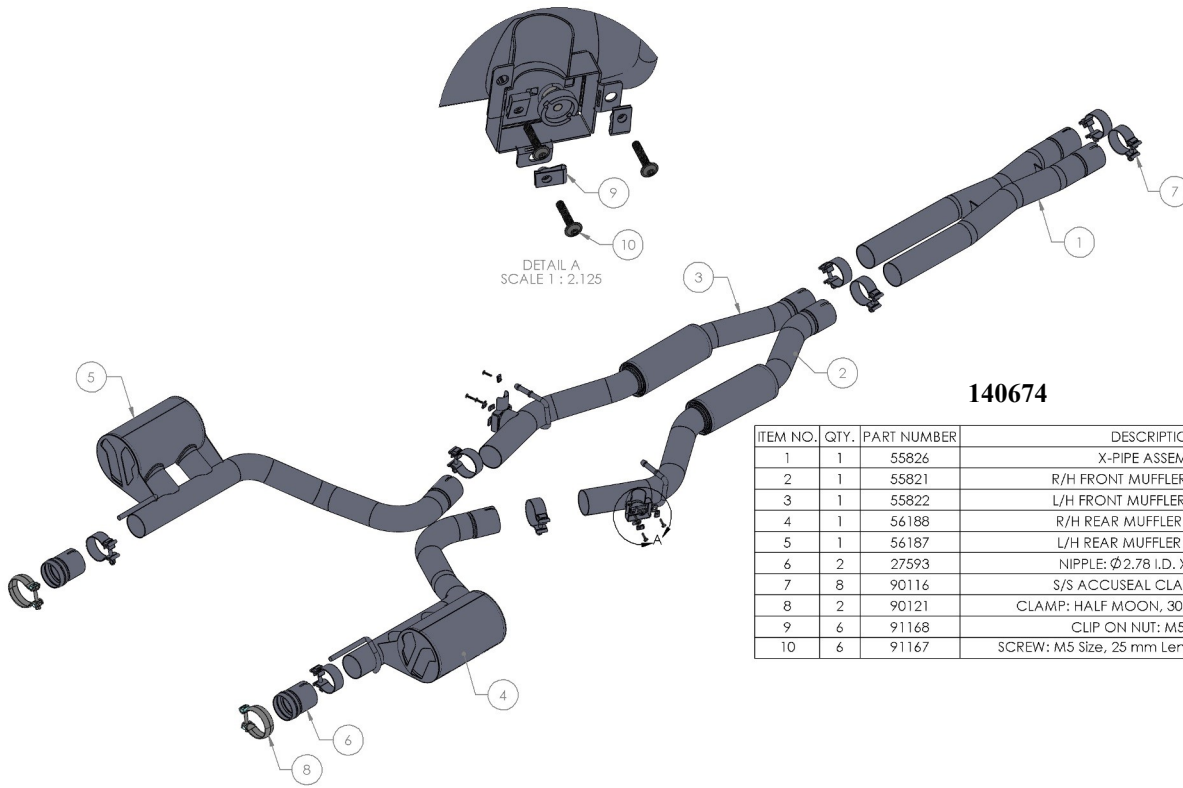

140674

ITEM NO.	QTY.	PART NUMBER	DESCRIPTION
1	1	55826	X-PIPE ASSEMBLY
2	1	55821	R/H FRONT MUFFLER ASSEMBLY
3	1	55822	L/H FRONT MUFFLER ASSEMBLY
4	1	56188	R/H REAR MUFFLER ASSEMBLY
5	1	56187	L/H REAR MUFFLER ASSEMBLY
6	2	27593	NIPPLE: Ø 2.78 I.D. X 3.75" LG.
7	8	90116	S/S ACCUSEAL CLAMP: Ø 2.75
8	2	90121	CLAMP: HALF MOON, 304SS, 70mm, 2.75"
9	6	91168	CLIP ON NUT: M5 x .8mm
10	6	91167	SCREW: M5 Size, 25 mm Length, 0.80 mm Pitch

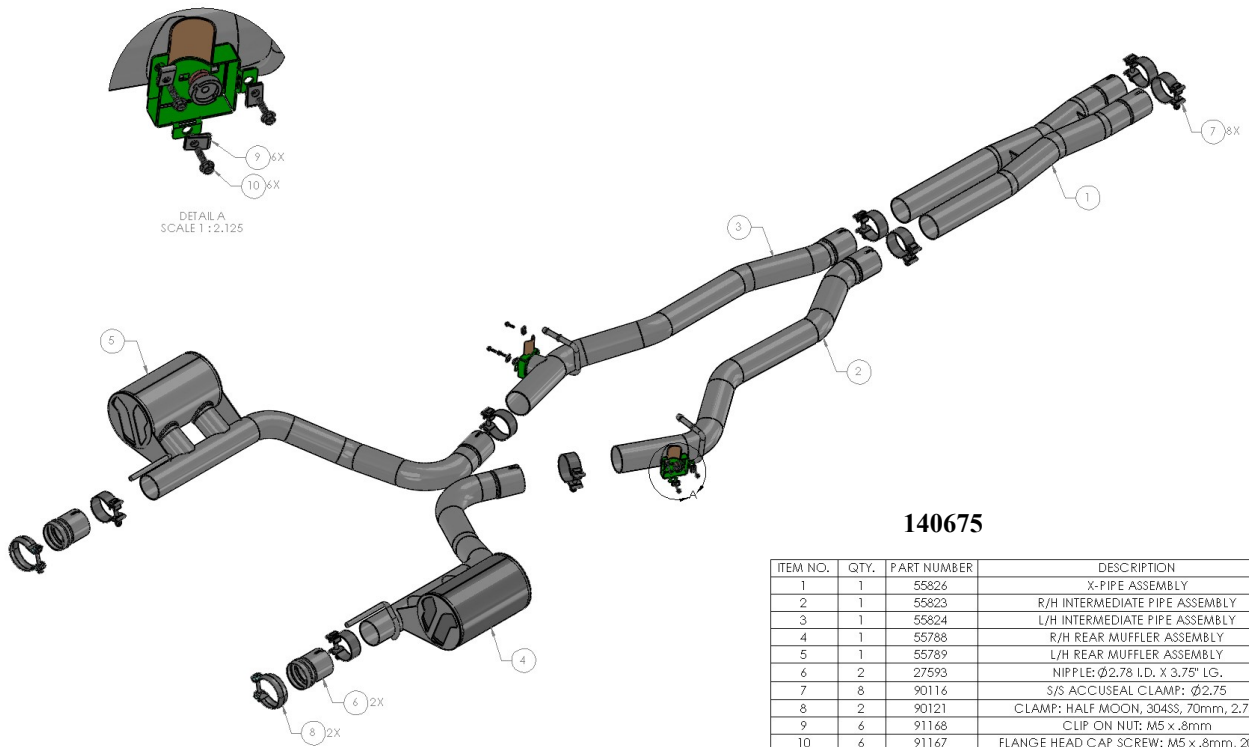

140675

ITEM NO.	QTY.	PART NUMBER	DESCRIPTION
1	1	55826	X-PIPE ASSEMBLY
2	1	55823	R/H INTERMEDIATE PIPE ASSEMBLY
3	1	55824	L/H INTERMEDIATE PIPE ASSEMBLY
4	1	55788	R/H REAR MUFFLER ASSEMBLY
5	1	55789	L/H REAR MUFFLER ASSEMBLY
6	2	27593	NIPPLE: Ø 2.78 I.D. X 3.75" LG.
7	8	90116	S/S ACCUSEAL CLAMP: Ø 2.75
8	2	90121	CLAMP: HALF MOON, 304SS, 70mm, 2.75"
9	6	91168	CLIP ON NUT: M5 x .8mm
10	6	91167	FLANGE HEAD CAP SCREW: M5 x .8mm, 20mm

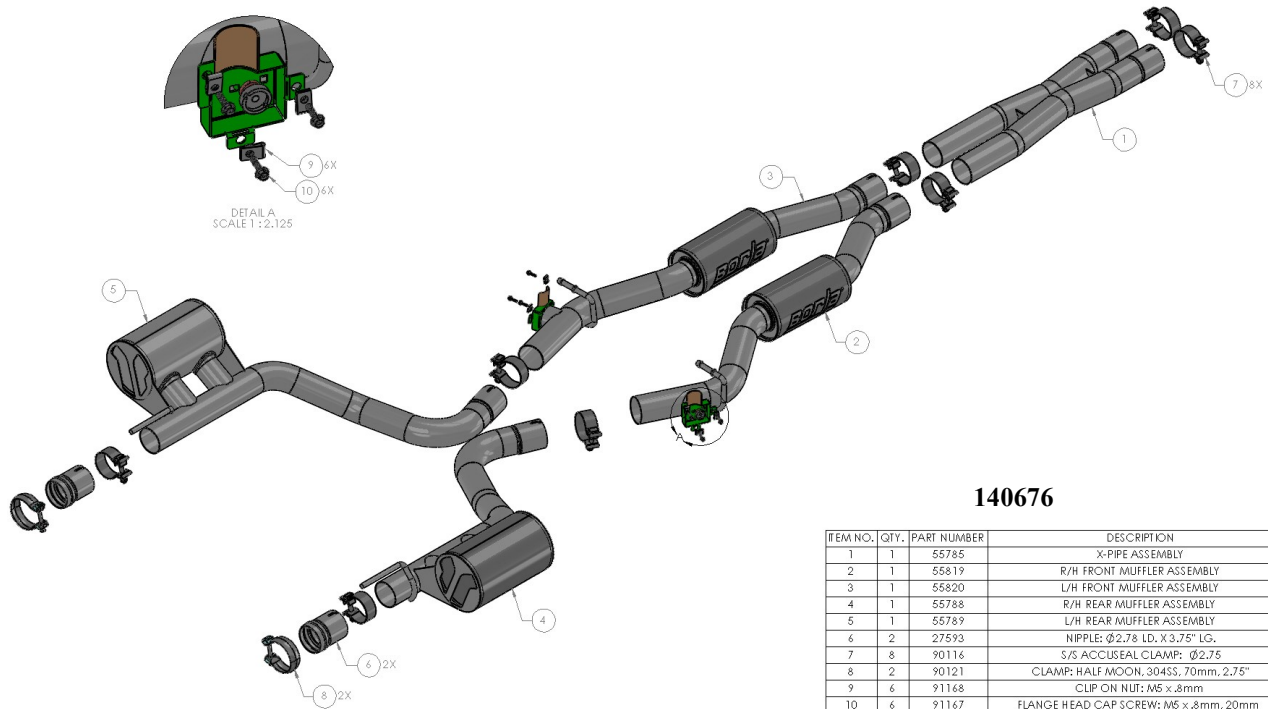

140676

ITEM NO.	QTY.	PART NUMBER	DESCRIPTION
1	1	55785	X-PIPE ASSEMBLY
2	1	55819	R/H FRONT MUFFLER ASSEMBLY
3	1	55820	L/H FRONT MUFFLER ASSEMBLY
4	1	55788	R/H REAR MUFFLER ASSEMBLY
5	1	55789	L/H REAR MUFFLER ASSEMBLY
6	2	27593	NIPPLE: Ø2.78 I.D. X 3.75" LG.
7	8	90116	S/S ACCUSEAL CLAMP: Ø2.75
8	2	90121	CLAMP: HALF MOON, 304SS, 70mm, 2.75"
9	6	91168	CLIP ON NUT: M5 x .8mm
10	6	91167	FLANGE HEAD CAP SCREW: M5 x .8mm, 20mm

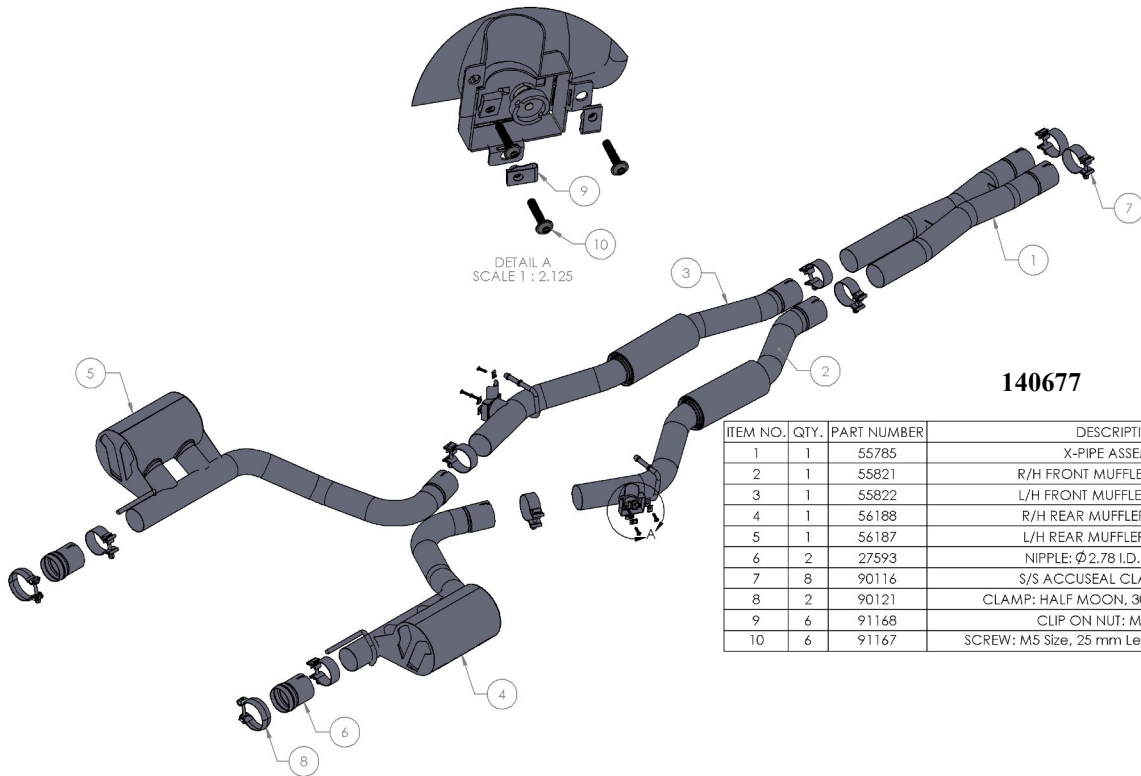

140677

ITEM NO.	QTY.	PART NUMBER	DESCRIPTION
1	1	55785	X-PIPE ASSEMBLY
2	1	55821	R/H FRONT MUFFLER ASSEMBLY
3	1	55822	L/H FRONT MUFFLER ASSEMBLY
4	1	56188	R/H REAR MUFFLER ASSEMBLY
5	1	56187	L/H REAR MUFFLER ASSEMBLY
6	2	27593	NIPPLE: Ø2.78 I.D. X 3.75" LG.
7	8	90116	S/S ACCUSEAL CLAMP: Ø2.75
8	2	90121	CLAMP: HALF MOON, 304SS, 70mm, 2.75"
9	6	91168	CLIP ON NUT: M5 x .8mm
10	6	91167	SCREW: M5 Size, 25 mm Length, 0.80 mm Pitch

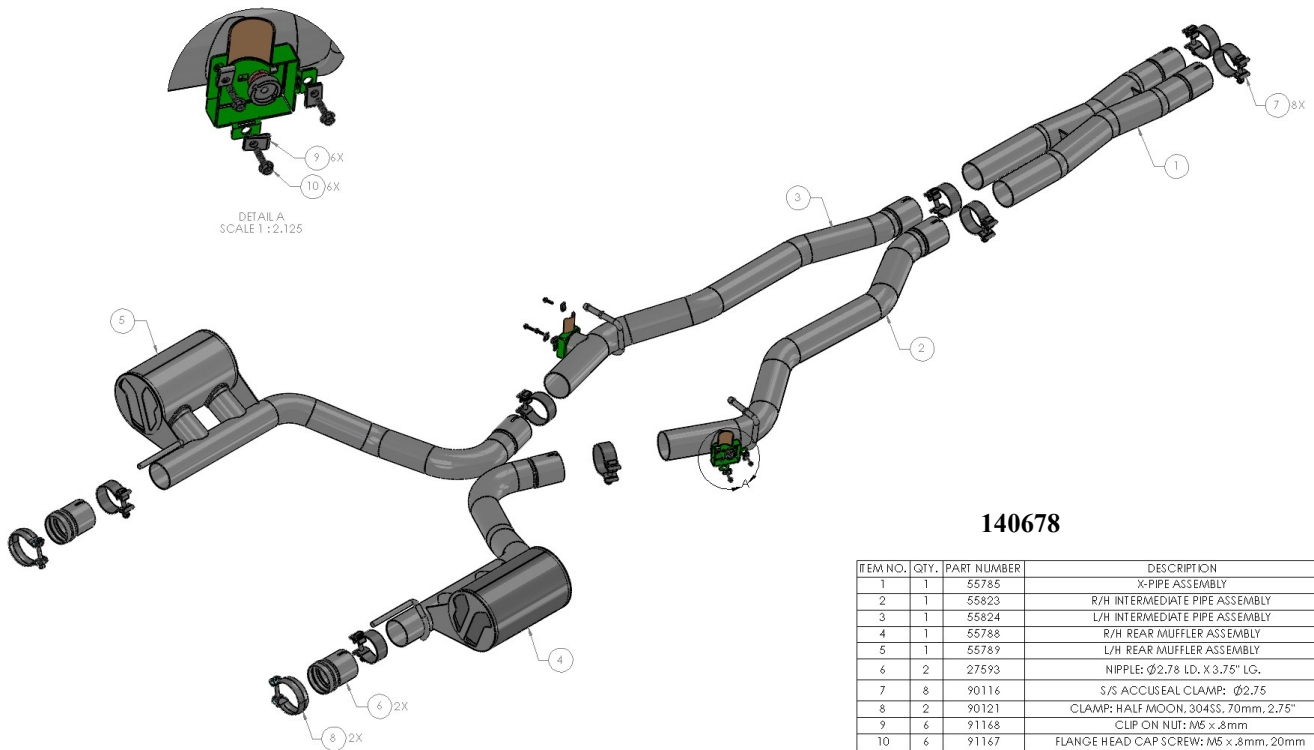

140678

ITEM NO.	QTY.	PART NUMBER	DESCRIPTION
1	1	55785	X-PIPE ASSEMBLY
2	1	55823	R/H INTERMEDIATE PIPE ASSEMBLY
3	1	55824	L/H INTERMEDIATE PIPE ASSEMBLY
4	1	55788	R/H REAR MUFFLER ASSEMBLY
5	1	55789	L/H REAR MUFFLER ASSEMBLY
6	2	27593	NIPPLE: Ø2.78 LD. X 3.75" LG.
7	8	90116	S/S ACCUSEAL CLAMP: Ø2.75
8	2	90121	CLAMP: HALF MOON, 304SS, 70mm, 2.75"
9	6	91168	CLIP ON NUT: M5 x .8mm
10	6	91167	FLANGE HEAD CAP SCREW: M5 x .8mm, 20mm

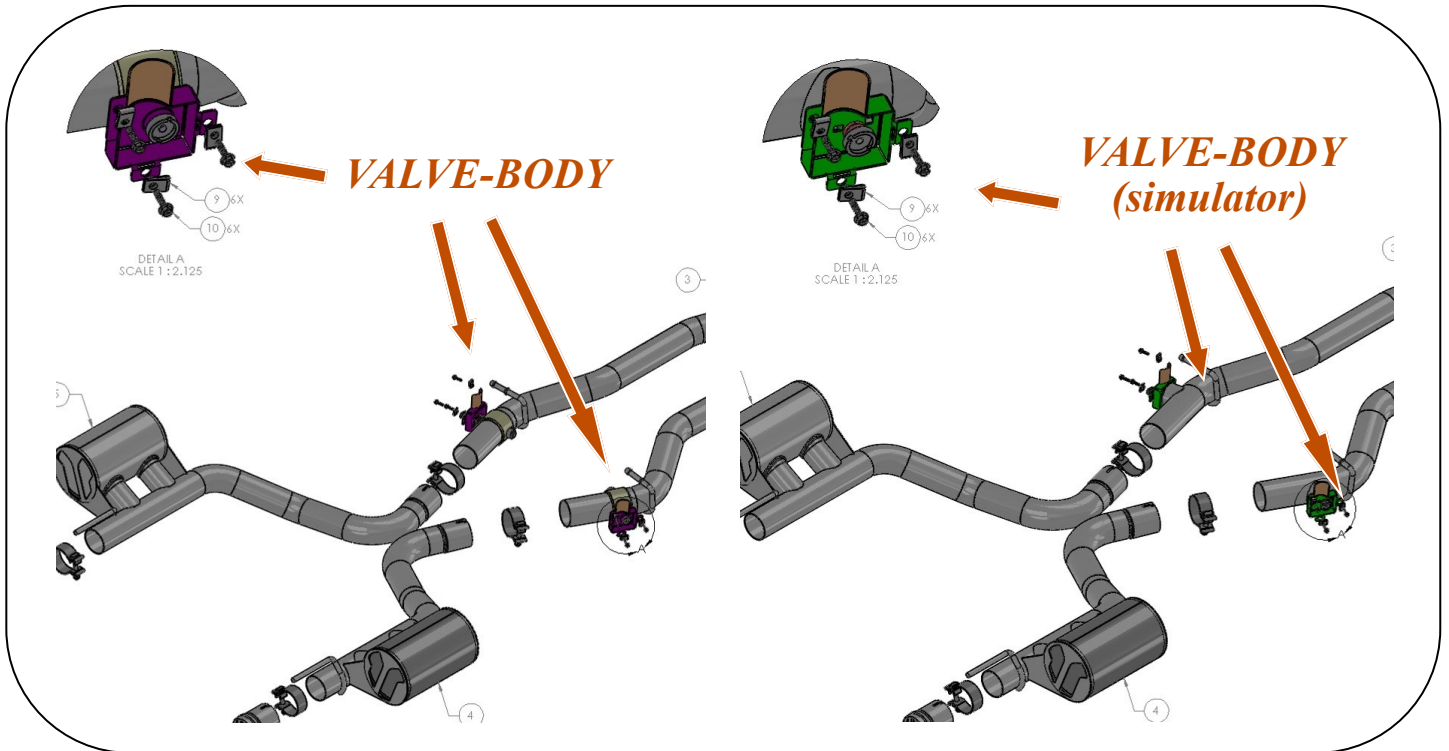

VALVE BODY



Electronic FACTORY ACTUATOR

NOTE: The electronic Factory Actuator body is a molded plastic material and the molded screw bosses are fragile. Care should be taken when tightening screws as these bosses are easily broken.

Caution!!! *Never work on a hot exhaust system. Serious injury in the form of burns can result if the vehicle has been in use and the exhaust system is hot, allow vehicle to cool for at least 1 hour. Always wear eye protection when working under any vehicle.*

Note: It is our recommendation that you use a hoist or hydraulic lift to facilitate the installation of your new Borla Performance Exhaust System.

Taking all under car safety precautions, lift the vehicle using a hoist or hydraulic lift. Once this has been done, you may begin the removal of your old exhaust system from your vehicle.

Note: Before removing the original exhaust system from your vehicle, please compare the parts you have received with the bill of materials provided on the previous page to assure that you have all the parts necessary for the installation of your new Borla Performance Exhaust System.

Note: With a used vehicle, we suggest a penetrating spray lubricant to be applied liberally to all exhaust fasteners and allowing a significant period of time for the chemical to lubricate the threads before attempting to disassemble.

Original Exhaust System Removal

NOTE: *The Factory Actuator body is a molded plastic material and the molded screw bosses are fragile. Care should be taken when tightening screws as these bosses are easily broken.*

1. Refer to page 13 for description of Valve Body and Actuator references.
2. Loosen the clamps located in front of the X-pipe assembly. (See Fig. 1)
3. Unclip wire harnesses from the left and right actuators on the factory exhaust. (See Fig. 2)
4. Using a muffler stand or an additional person to hold the exhaust in place, carefully remove the exhaust hangers from the rubber isolators. Keep the hardware for reinstallation. (See Fig. 3)
5. Remove left and right factory actuators from the factory exhaust. These will be transferred to your new Borla system on page 15 of this installation manual.
6. Remove left and right exhaust tips from the factory exhaust and install both tips to your new Borla exhaust system using the factory hardware. (See Fig.4)

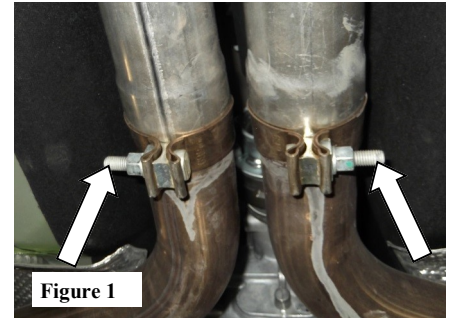

Figure 1

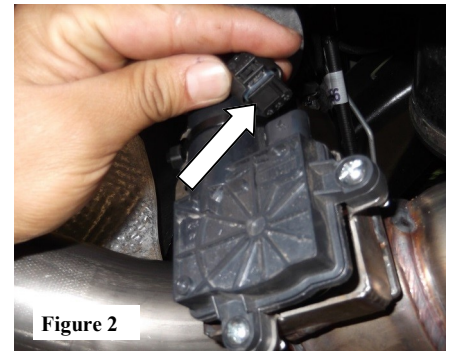

Figure 2

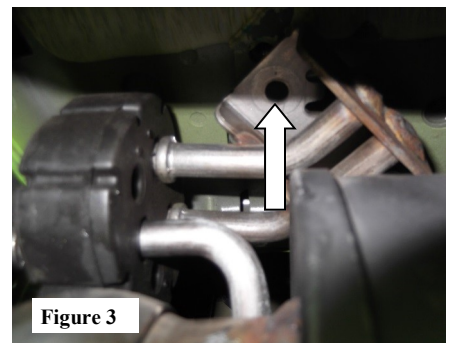

Figure 3

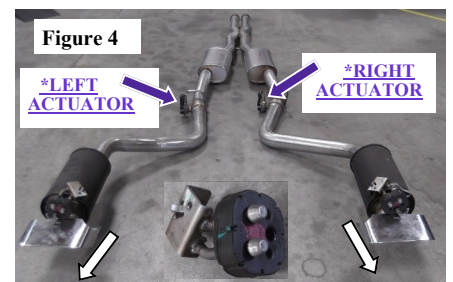

Figure 4

***NOTE:** *IMPROPER INSTALLATION OF THE ACTUATOR WILL TRIGGER A CHECK ENGINE LIGHT. WE SUGGEST YOU IDENTIFY THE ACTUATOR USING TAPE OR A MARKING PEN.*

WARNING: *Use extreme caution during installation. Torque all fasteners according to manufacturer's torque values and tightening sequence. DO NOT use air impact tools to tighten fasteners on Borla Performance Exhaust Systems. Use of such tools may result in bent flanges or gasket contact areas leading to exhaust leaks.*

NOTE: *When you first start your vehicle after the installation of your new Borla Performance Exhaust System, there may be some smoke and fumes coming from the system. This is a protective oil based coating used in the manufacturing of mandrel bent performance exhaust tubing. This is not a problem and will disappear within a very short period of time after the exhaust has reached normal operating temperatures.*

Borla Performance Cat-Back™ Exhaust System Installation

NOTE: The Factory Actuator body is a molded plastic material and the molded screw bosses are fragile. Care should be taken when tightening screws as these bosses are easily broken.

1. Place a clamp over each inlet of the **X-pipe Assembly** and insert inlet into factory header outlet pipes. (See Fig. 5) **DO NOT TIGHTEN THE CLAMPS.**
2. Place a clamp over the expanded end of the **L/H (Front Muffler or Intermediate Pipe) Assembly** and insert to left-side **X-Pipe Assembly** outlet. Repeat for **R/H (Front Muffler or Intermediate Pipe) Assembly** to right-side **X-Pipe Assembly** outlet. Insert hangers into factory rubber isolators. (See Fig. 6) **DO NOT TIGHTEN THE CLAMPS.**
3. Place a clamp over the expanded end of **L/H Rear Muffler Assembly** and insert into outlet of the **X-Pipe Assembly** outlet. Insert the hanger bracket into the rubber isolator. Repeat for **R/H Rear Muffler Assembly** to right-side **X-Pipe Assembly** outlet. (See Fig. 7) **DO NOT TIGHTEN THE CLAMPS.**
4. Install left and right factory tips using provided **Clamps & adapters**.
5. Check your exhaust system for proper clearance under the vehicle and also for tip alignment. (See Fig. 8)
6. Once position has been determined to be correct, begin tightening clamp bolts working from the front of the vehicle to the rear. Tighten the Accuseal clamps to 32 -35 ft. lbs.

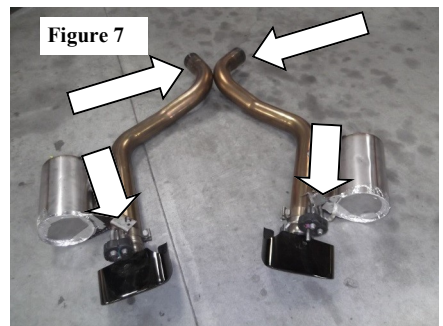
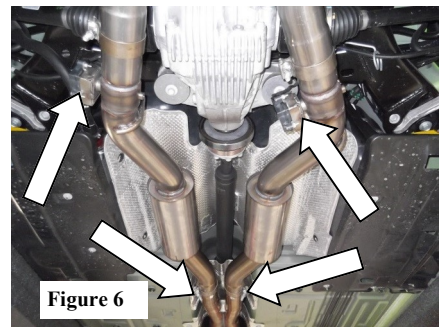
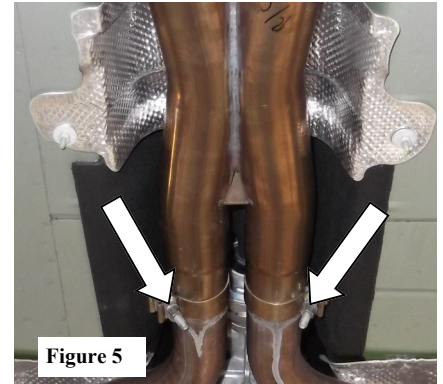

***NOTE: IMPROPER INSTALLATION OF THE ACTUATOR WILL TRIGGER A CHECK ENGINE LIGHT. WE SUGGEST YOU IDENTIFY THE ACTUATORS USING TAPE OR A MARKING PEN.**

WARNING: Use extreme caution during installation. Torque all fasteners according to manufacturer's torque values and tightening sequence. **DO NOT** use air impact tools to tighten fasteners on Borla Performance Exhaust Systems. Use of such tools may result in bent flanges or gasket contact areas leading to exhaust leaks.

NOTE: When you first start your vehicle after the installation of your new Borla Performance Exhaust System, there may be some smoke and fumes coming from the system. This is a protective oil based coating used in the manufacturing of mandrel bent performance exhaust tubing. This is not a problem and will disappear within a very short period of time after the exhaust has reached normal operating temperatures.

Borla Performance Cat-Back™ Exhaust System Installation

NOTE: The electronic Factory Actuator body is a molded plastic material and the molded screw bosses are fragile. Care should be taken when tightening screws as these bosses are easily broken.

7. **IMPORTANT: VERIFY YOU ARE INSTALLING THE LEFT-SIDE ACTUATOR.** Begin on **LEFT-SIDE** of vehicle exhaust.
8. Note the **VALVE-BODY Spring-Slot** and the rotation angle. **DO NOT CONNECT THE SPRING TO THIS SLOT.** The spring will engage automatically when vehicle is started on **STEP 12.** (See Fig. A)
9. Install and align the spring to the **LEFT-SIDE FACTORY ACTUATOR Spring-Slot** as shown. (See Figs. B1 & B2)
10. Install the factory actuator to **L/H Rear Muffler Assembly** carefully aligning the 3-holes to the valve-body bolts. Verify the spring is aligned to the **FACTORY ACTUATOR Spring-Slot** before inserting. (See Fig. C)
11. Hold the factory actuator close to the valve body and engage (3) screws to the bolts but **DO NOT tighten all the way to the actuator body (use only 3-4 thread engagement).** It is important to have a **GAP** to allow the spring space to rotate and automatically engage the **VALVE-BODY Spring-Slot.** (See Figs. D1 & D2)
12. Connect the wire harness to the factory actuator. (See Fig. E)
13. **CAUTION: Verify vehicle is secure and safe before starting.** Start vehicle allowing electronic actuator to cycle through diagnostics. In this process the spring will “click” into position and automatically self-aligning spring to the exhaust-side spring-connecting-slot. Verify the spring engagement to the **VALVE-BODY Spring-Slot.** Repeat **STEPS 9-12** to engage the spring.
14. Tighten (3) nuts on valve actuator to 6-ft lbs torque. (See Fig. F)
15. Repeat above STEPS 8-14 for **Right Side Rear Muffler Assembly** installation.
16. Before starting your vehicle, make sure to check all wires, hoses, brake lines, body parts and tires for safe clearance from the exhaust system.
17. Start vehicle and check for any leaks. If any leaks are found, determine cause (such as loose or incorrectly positioned clamp) and repair as necessary.

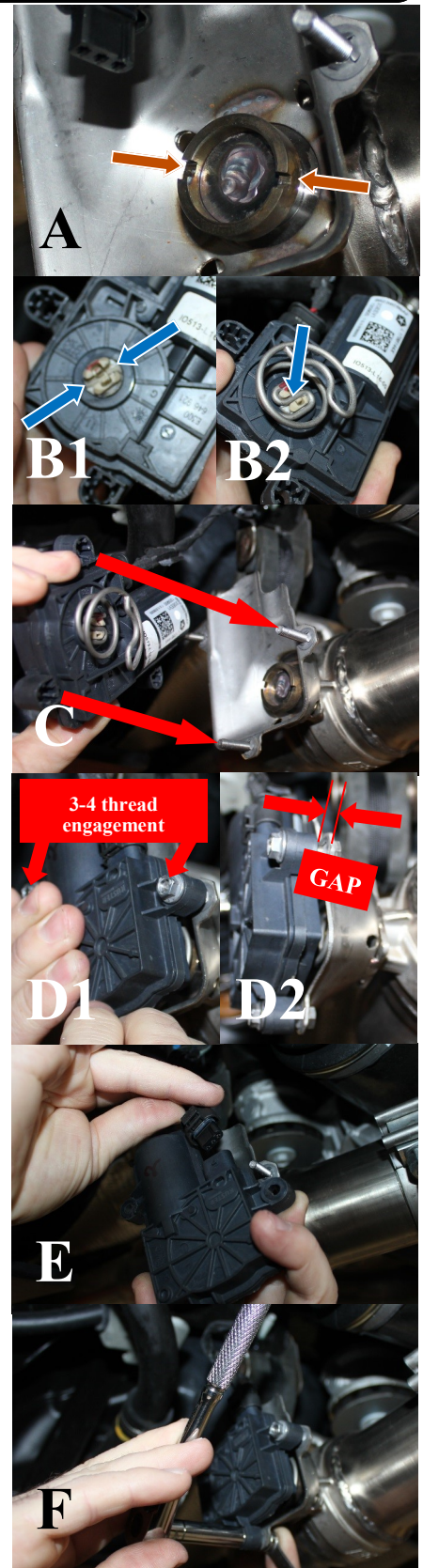

***NOTE: IMPROPER INSTALLATION OF THE ACTUATOR WILL TRIGGER A CHECK ENGINE LIGHT. WE SUGGEST YOU IDENTIFY THE ACTUATORS USING TAPE OR A MARKING PEN.**

WARNING: Use extreme caution during installation. Torque all fasteners according to manufacturer's torque values and tightening sequence. **DO NOT** use air impact tools to tighten fasteners on Borla Performance Exhaust Systems. Use of such tools may result in bent flanges or gasket contact areas leading to exhaust leaks.

NOTE: When you first start your vehicle after the installation of your new Borla Performance Exhaust System, there may be some smoke and fumes coming from the system. This is a protective oil based coating used in the manufacturing of mandrel bent performance exhaust tubing. This is not a problem and will disappear within a very short period of time after the exhaust has reached normal operating temperatures.