



## INSTALLATION GUIDE: AWE EXHAUST SUITE FOR THE 4TH GEN RAM 1500 5.7L

For up-to-date information, please visit the products page on

[AWE-Tuning.com](http://AWE-Tuning.com).

### THIS GUIDE IS INTENDED FOR THE FOLLOWING PART NUMBERS:

- 3015-32002 AWE 0FG Dual Rear Exit Catback Exhaust for 4th Gen RAM 1500 5.7L (with bumper cutouts) - Chrome Silver Tips
- 3015-33004 AWE Cat-Back Dual Rear Exit Exhaust for 4th Gen RAM 1500 5.7L (with bumper cutouts) - Diamond Black Tips
- 3015-32101 AWE Cat-Back Dual Rear Exit Exhaust for 4th Gen RAM 1500 5.7L (without bumper cutouts) - Chrome Silver Tips
- 3015-33104 AWE Cat-Back Dual Rear Exit Exhaust for 4th Gen RAM 1500 5.7L (without bumper cutouts) - Diamond Black Tips
- 3015-32304 AWE Cat-Back Single Side Exit Exhaust for 4th Gen RAM 1500 5.7L - Dual Chrome Tips
- 3015-33309 AWE Cat-Back Single Side Exit Exhaust for 4th Gen RAM 1500 5.7L - Dual Diamond Black Tips

Welcome to the AWE family, and congratulations on your purchase of the AWE Exhaust system for the 4th Gen RAM 1500 5.7L.

Exquisite build quality and craftsmanship, coupled with industry leading performance, distinguish this exhaust system from all others.

\*For up to the minute fitment information, be sure to visit the AWE website. As always, AWE Performance Specialists are standing by for any questions, [right here](#).

# PARTS LIST: OFG DUAL EXIT EXHAUST WITH BUMPER CUTOUTS



INSPECT ALL PARTS PRIOR TO DISASSEMBLY OF VEHICLE; IF DAMAGED OR MISSING, PLEASE CONTACT THE PLACE OF PURCHASE IMMEDIATELY.

Symbol	Part Number	Description	QTY
	D78	AWE RAM 4th Gen Inlet Section	1
	D81	AWE RAM 4th Gen Axle Tube Dual Driver	1
	D82	AWE RAM 4th Gen Axle Tube Dual Passenger	1
	D85	AWE RAM 4th Gen Rear Exit Dual With Cutout Driver	1
	D86	AWE RAM 4th Gen Rear Exit Dual With Cutout Passenger	1
	C17	AWE Stamped Merge Assembly	1
<b>A</b> >>	E23	AWE RAM 4th and 5th Gen Rear Exit Dual With Cutout Tip Outlet	2
<b>B</b> >>	TAS300	3.00in AccuSeal, stainless steel band clamp	6
<b>C</b> >>	3910-11012	Clamp kit	1
<b>D</b> >>	SEC75	3" Barrel Clamp (Bubble)	2
<b>E</b> >>	180006	AWE Chrome 5" Slash Cut Tip	2
<b>F</b> >>	180007	AWE Black 5" Slash Cut Tip	2

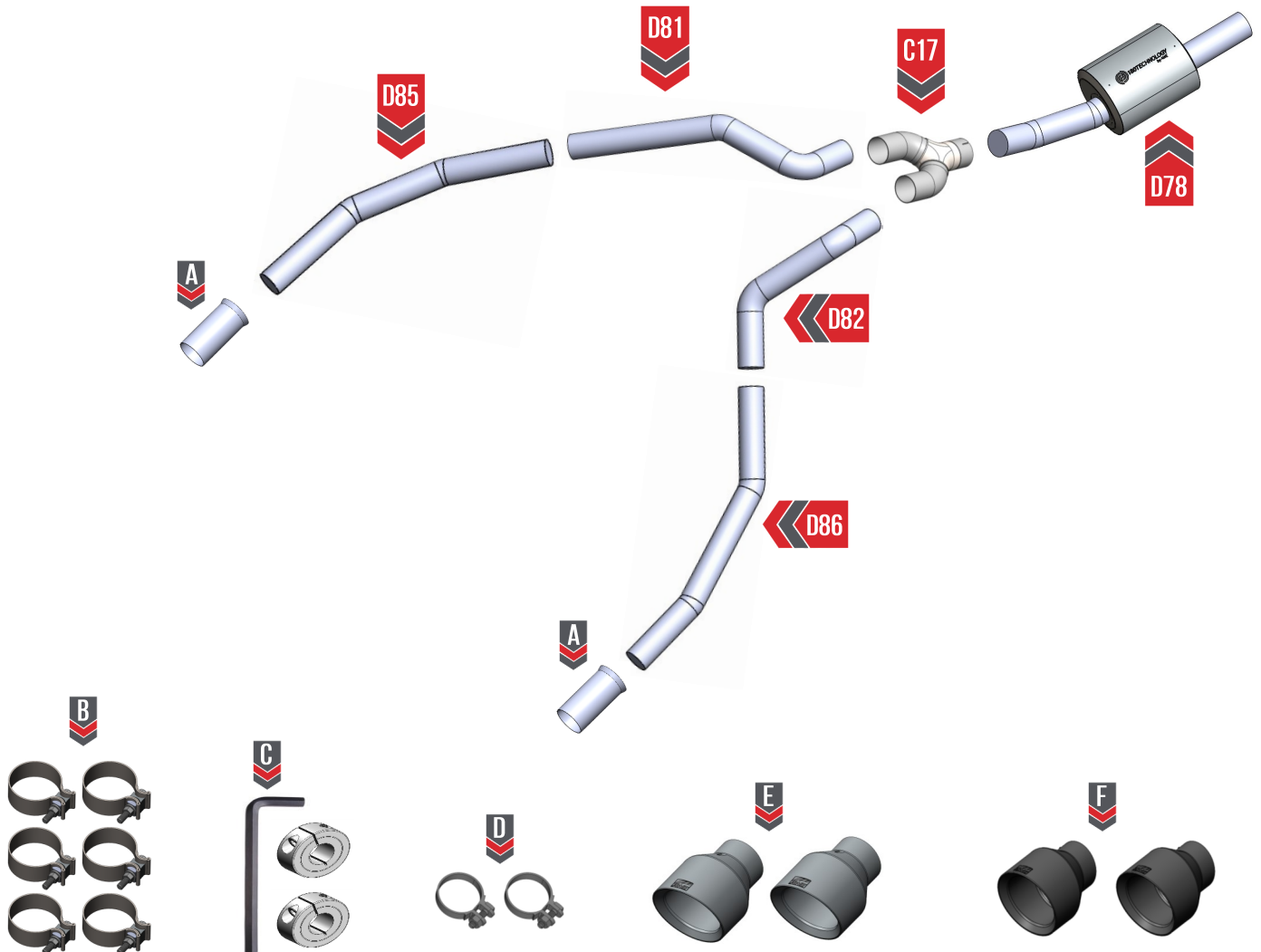

# PARTS LIST: OFG DUAL EXIT EXHAUST W/O BUMPER CUTOUTS



INSPECT ALL PARTS PRIOR TO DISASSEMBLY OF VEHICLE; IF DAMAGED OR MISSING, PLEASE CONTACT THE PLACE OF PURCHASE IMMEDIATELY.

Symbol	Part Number	Description	QTY
	D78	AWE RAM 4th Gen Inlet Section	1
	D81	AWE RAM 4th Gen Axle Tube Dual Driver	1
	D82	AWE RAM 4th Gen Axle Tube Dual Passenger	1
	D87	AWE RAM 4th Gen Rear Exit Dual Without Cutout Driver	1
	D88	AWE RAM 4th Gen Rear Exit Dual Without Cutout Passenger	1
	C17	AWE Stamped Merge Assembly	1
	D01	AWE Bash Guard	2
<b>A</b> >>	TAS300	3.00in AccuSeal, stainless steel band clamp	6
<b>B</b> >>	3910-11012	Clamp kit	1
<b>C</b> >>	52103718AB	Hanger/Insulator	
<b>D</b> >>	180003	AWE Chrome 5" Straight Cut Tip	2
<b>E</b> >>	180003BC	AWE Black 5" Straight Cut Tip	2

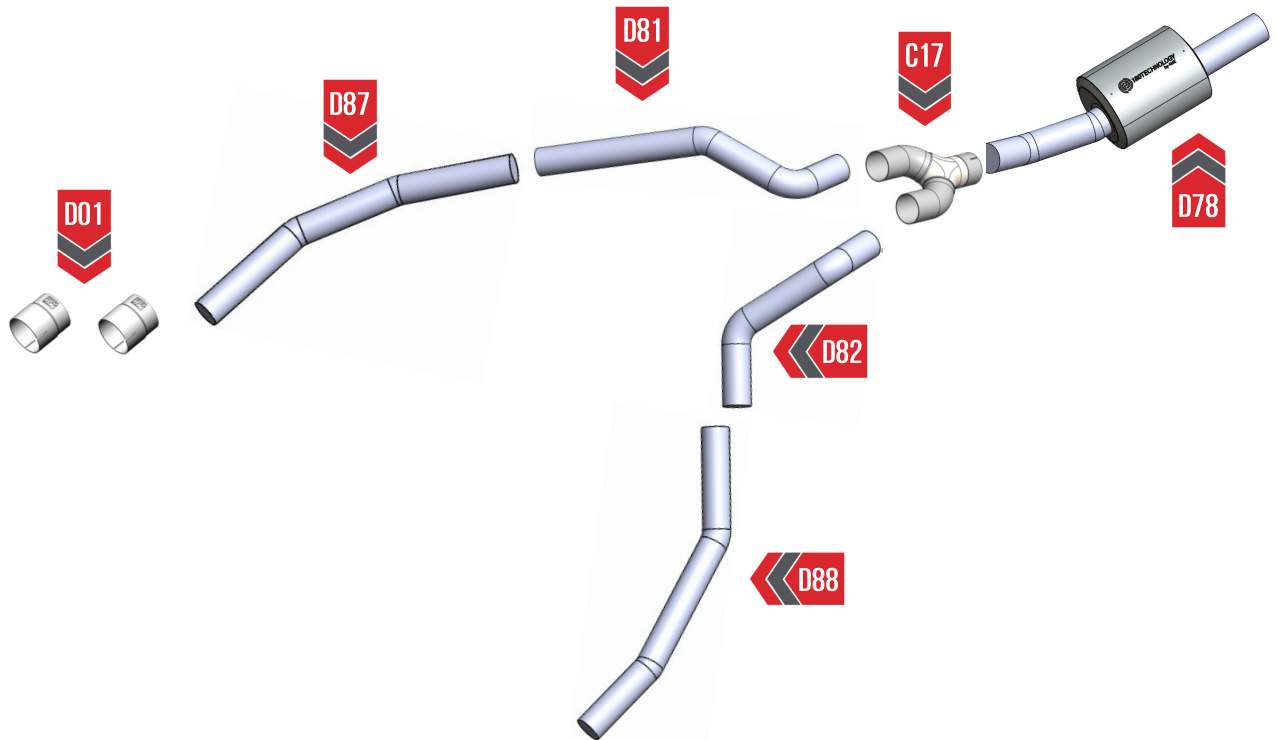

# PARTS LIST: OFG SINGLE EXIT EXHAUST

INSPECT ALL PARTS PRIOR TO DISASSEMBLY OF VEHICLE; IF DAMAGED OR MISSING, PLEASE CONTACT THE PLACE OF PURCHASE IMMEDIATELY.

Symbol	Part Number	Description	QTY
	D78	Ram 4th Gen Inlet Section	1
	D79	Ram 4th Gen Single Side Midpipe	1
	D80	Ram 4th Gen Single Side Tip Outlet Section	1
	D01	AWE Bash Guard	1
<b>A</b> >>	390300	3 Inch SS Smart Seal Band Clamp	4
<b>B</b> >>	3910-11012	Clamp-Kit	1
	61000455-ETCH	AWE Chrome 4.5" Slash Cut Tip	2
	61000488-ETCH	AWE Black 4.5" Slash Cut Tip	2

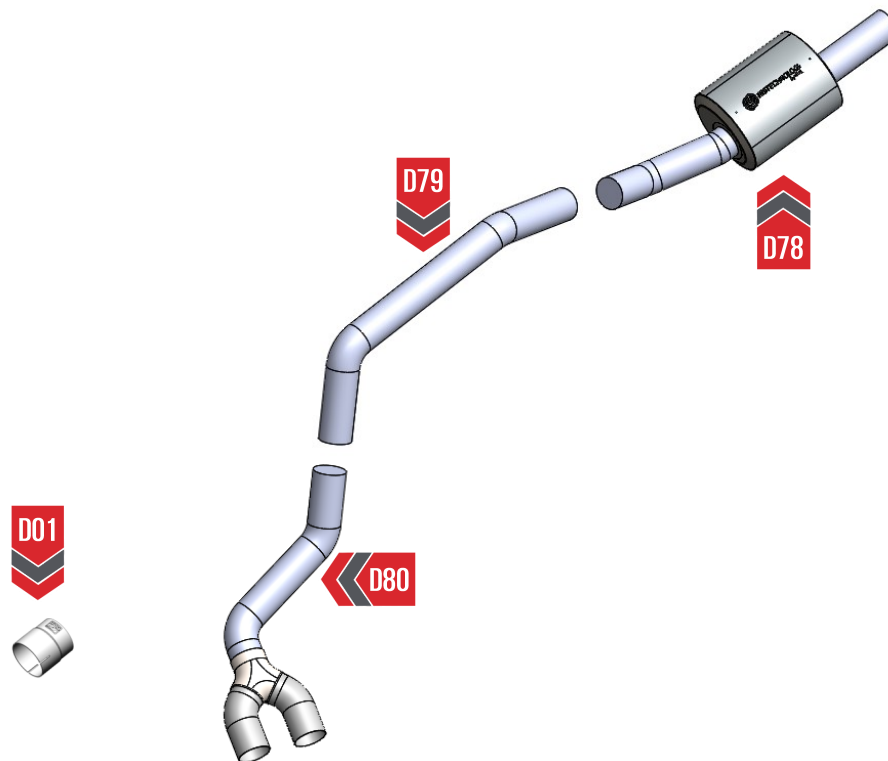



**NOTE:** Always refer to the manufacturer’s service manual for precise torque specifications on all OEM fasteners.



**CAUTION:** The exhaust may be **VERY HOT** — allow adequate time for the system to cool down before disassembly. Severe burns and injury will occur if skin comes into contact with a hot exhaust system.

**Table of Contents:**



- OE Removal (Step 1A/1B)
- AWE **Mid-Section** Install (Steps 2 - 3)
- AWE **Dual** Exhaust Install (Steps 4 - 22)
- AWE **Bashguard** install (steps 23-24)
- AWE **Single** Exhaust Install (Steps 25 - 31)



**STEP 1A IS ONLY FOR TRUCKS WITH BUMPER CUTOUTS**



## STEP 1A

Start by removing the OE RAM exhaust by following the steps, shown in **Figure 1A**.



Soak all bolts, and hangers in penetrant fluid before working.

1. Loosen the OE clamps at arrows (A).
2. Remove the OE rubber hangers at arrow (B), this will allow you to remove the rear tail pipe sections.
3. With the tail pipe sections removed, loosen the clamp at arrow (C).
4. Remove the hanger at arrow (D), and remove the OE muffler section.

**Note:** The rubber hanger closest to the flange has a ground strap that will be reinstalled with your AWE system.

**Note:** OE hangers WILL be reused.

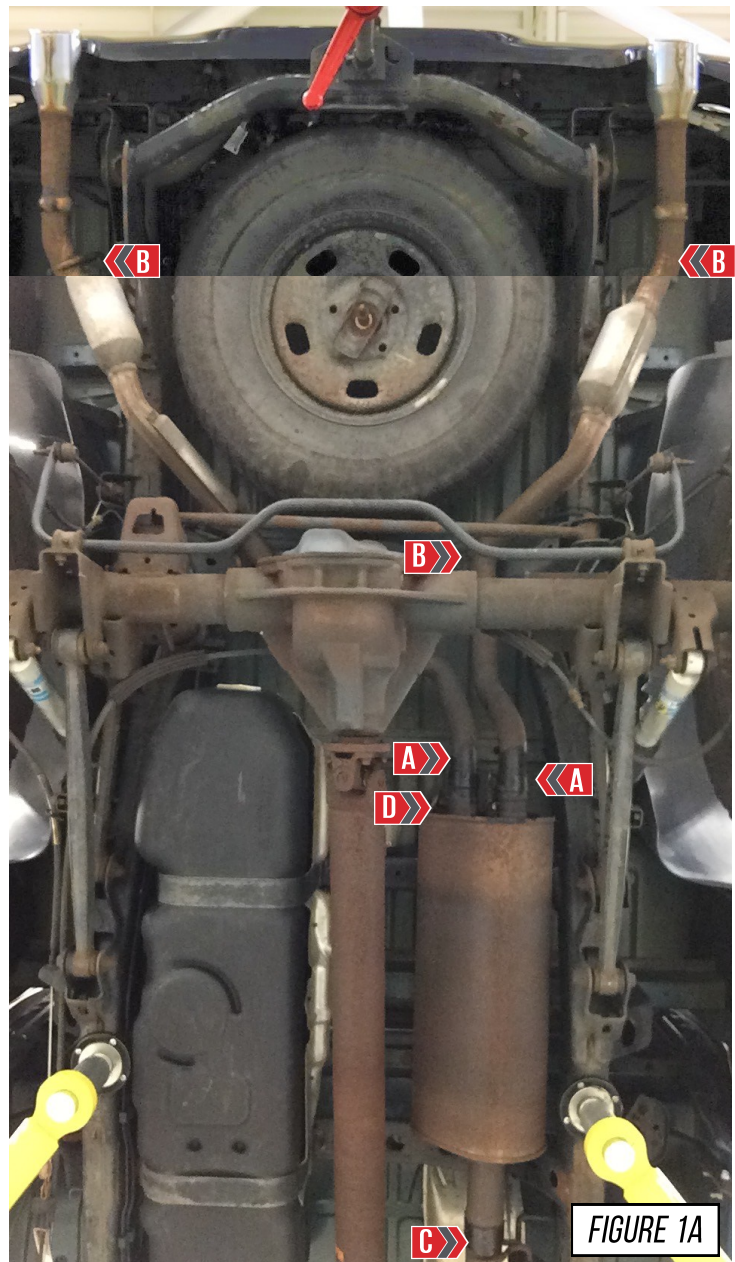

**FIGURE 1A**



**NOTE:** Always refer to the manufacturer's service manual for precise torque specifications on all OEM fasteners.



**CAUTION:** The exhaust may be **VERY HOT** — allow adequate time for the system to cool down before disassembly. Severe burns and injury will occur if skin comes into contact with a hot exhaust system.



**STEP 1B IS ONLY FOR TRUCKS WITHOUT BUMPER CUTOUTS**



## STEP 1B

Start by removing the OE RAM exhaust by following the steps, shown in **Figure 1B**.

Soak all bolts, and hangers in penetrant fluid before working.

1. Loosen the OE clamps at arrows **(A)**.
2. Remove the OE rubber hangers at arrow **(B)**, this will allow you to remove the rear tail pipe sections.
3. With the tail pipe sections removed, loosen the clamp at arrow **(C)**.
4. Remove the hanger at arrow **(D)**, and remove the OE muffler section.

**Note:** The rubber hanger closest to the flange has a ground strap that will be reinstalled with your AWE system.

**Note:** OE hangers **WILL** be reused.

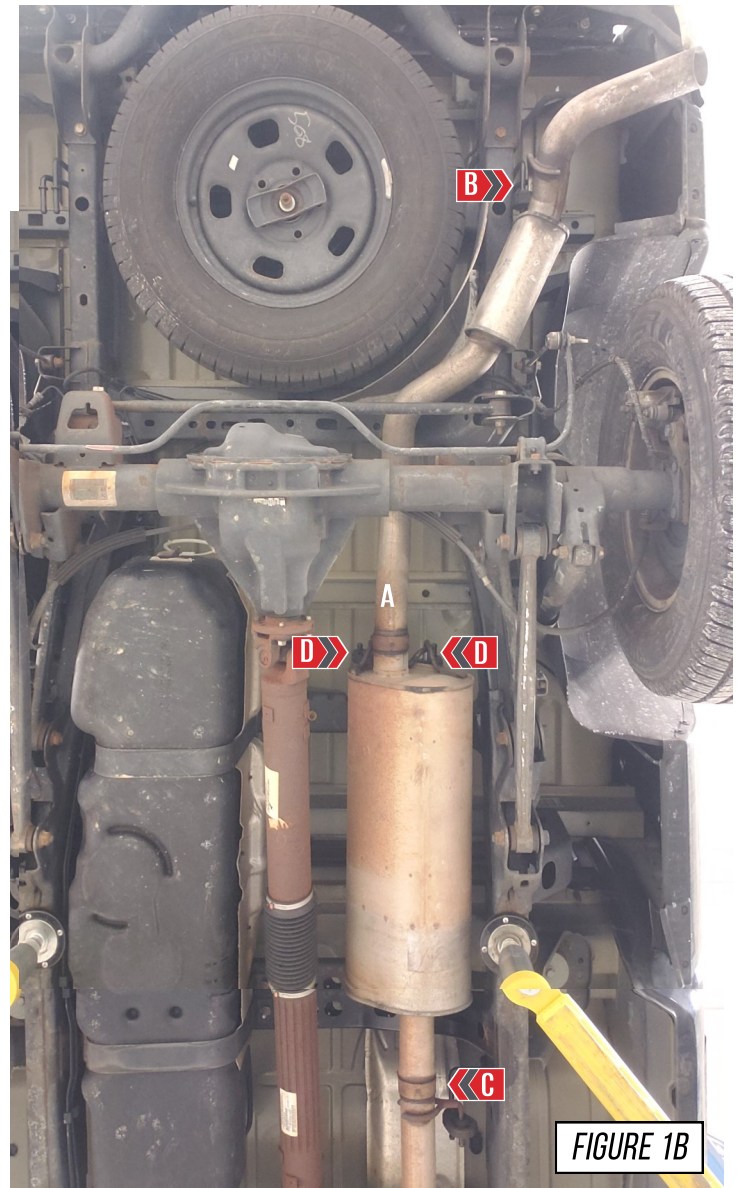

FIGURE 1B

## STEP 2

To begin insert your AWE midpipe (D78), first start by inserting the hanger bars into the OE rubber hangers as shown in **Figure 2**.



It is important to lubricate all hangers before hanging the midpipe.

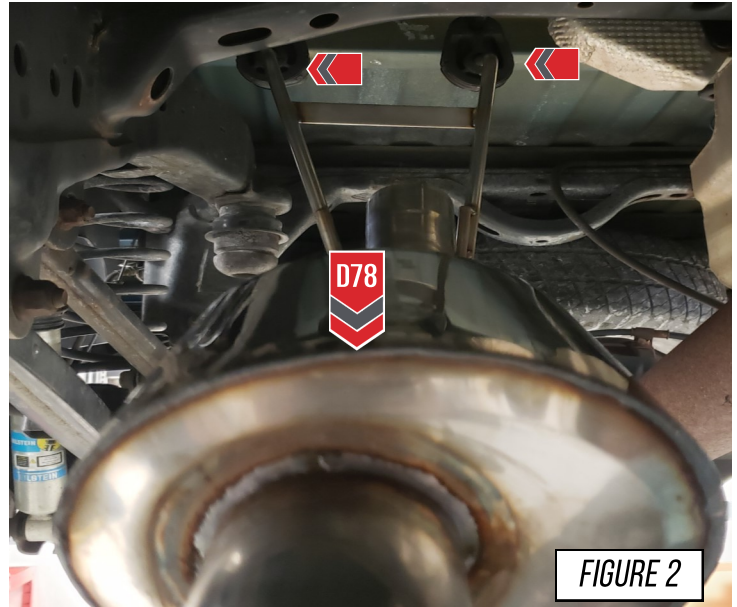

## STEP 3

Put one of the provided clamp on the front end of the AWE Midpipe (D78).

Line up your AWE Midpipe with the OE front pipe, as shown in **Figure 3-1**.

Slip the AWE Midpipe over the OE front pipe, and bottom it out to the button on the OE pipe. Snug the clamp to allow for adjustment, as shown in **Figure 3-2**.

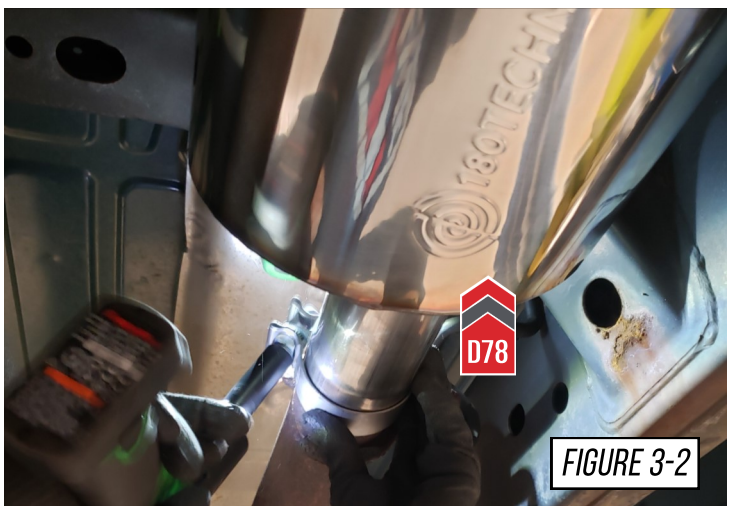

**IF INSTALLING THE SINGLE SIDE EXIT EXHAUST SYSTEM, SKIP TO STEP**

**21**



## STEP 4

Put one of the provided clamp (**A**) on the rear end of your AWE Midpipe (**D78**).

Slide the single side of your AWE stamped merge (**C17**) over the rear of the AWE Midpipe, as shown in **Figure 4**.



## STEP 5

Level the AWE stamped merge (**C17**) so both outlets are equally distant from the underside of the truck, as shown in **Figure 5**.

Slip the provided clamps over both outlet sides of the AWE stamped merge.





## STEP 6

Put your AWE axle tube dual driver side (**D81**) in place by inserting it over the rear axle, as shown in **Figure 6**.



## STEP 7

Slide the hanger bar of your AWE driver side axle tube (**D81**) into the OE hanger on the truck, as shown at (**A**) in **Figure 7**, while simultaneously aligning the AWE axle tube with the AWE merge (**C17**).

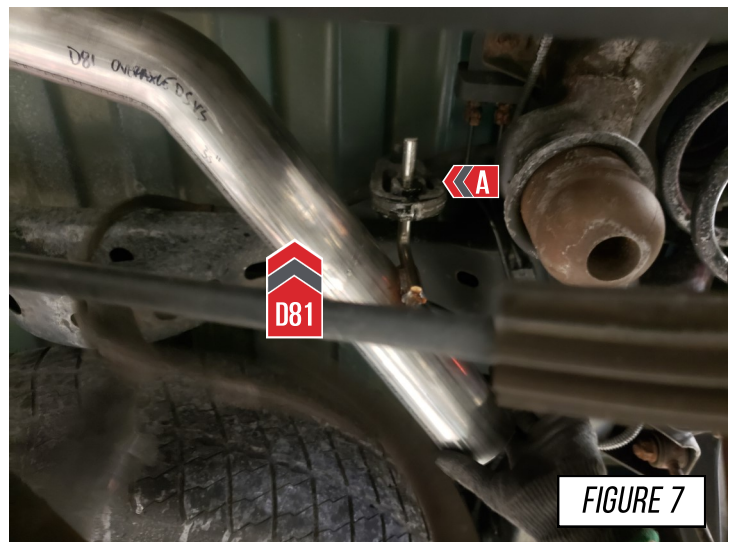

## STEP 8

Bottom out your AWE driver side axle tube (**D81**) out on the AWE merge (**C17**), as shown in **Figure 8**. Snug the clamp on the tube.



**Note:** It is important to not tighten the clamp all the way as adjustments may be needed at the end of installation.



## STEP 9

Put your AWE passenger side axle tube (D82) in place by inserting it over the rear axle, as shown in **Figure 9**.

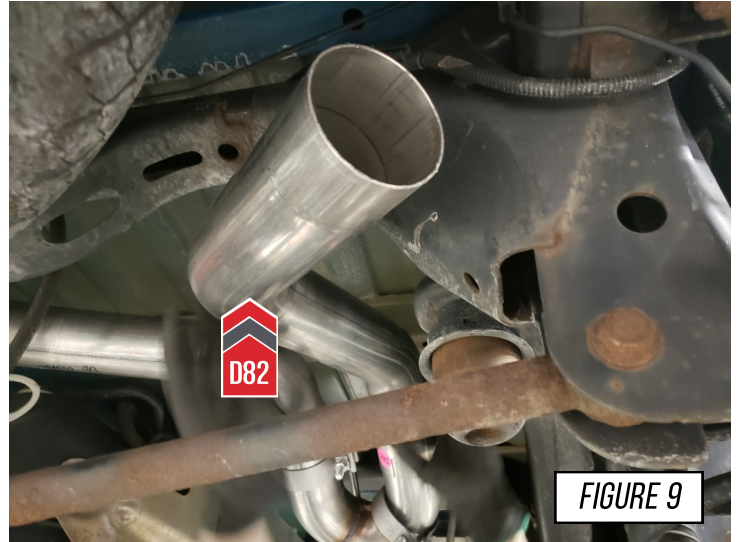

## STEP 10

Bottom out your AWE passenger side axle tube (D82) out on the AWE merge (C17), as shown in **Figure 10**.

Snug the clamp on the tube. It is important to not tighten the clamp all the way as adjustments may be needed at the end of installation.

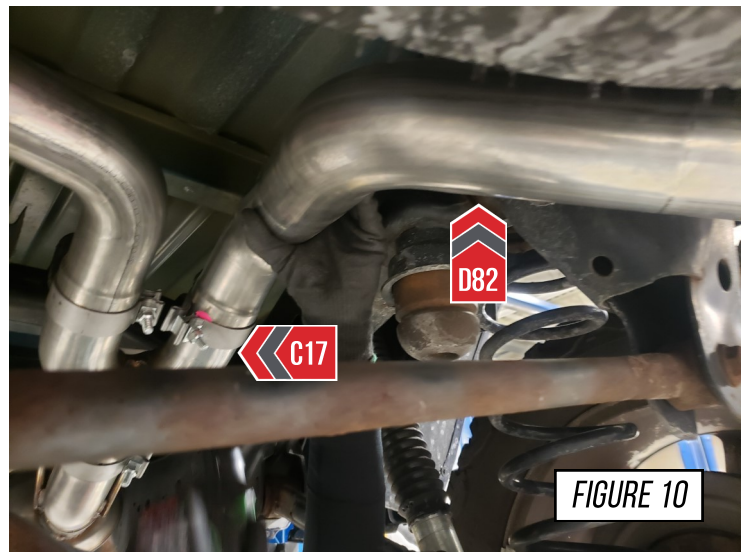

**STEPS 10-15 APPLY TO FLAT BUMPER TRUCKS AND BUMPER CUTOUT TRUCKS**



## STEP 11

Install your AWE passenger side rear exit tube (D86/D88), by simultaneously putting the hanger bar into the OE hanger, shown at (A), while lining up the inlet of (D86/D88) with (D82), as shown at (B) in **Figure 11**.

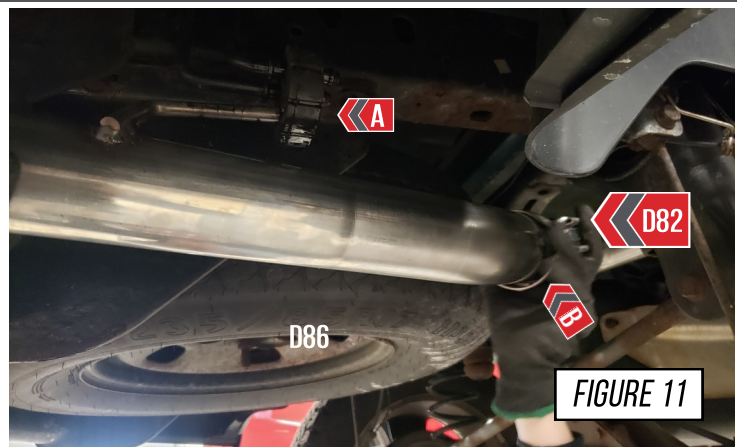

## STEP 12

Snug the clamp on your AWE rear exit dual passenger side tube (D86/D88), as shown in **Figure 12**.

It is important to only snug the clamp as adjustments may be required for final tip fitment.

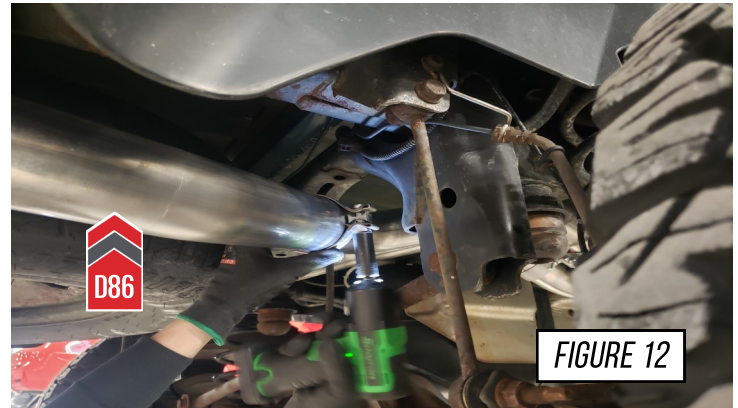

FIGURE 12

## STEP 13



**ONLY COMPLETE STEP 13 IF YOU OWN A FLAT BUMPER TRUCK**



Install the provided hanger/insulator (**A**) on the OE hanger bars, as shown in **Figure 13**.

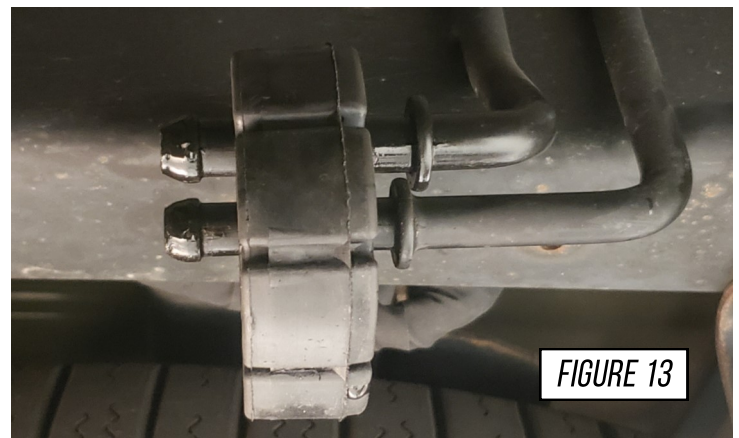

FIGURE 13

## STEP 14

It is crucial to install each section and exhaust band clamps correctly to prevent loose joints, exhaust leaks and rattles.

**Arrow A** shows the expanded pipe and the preinstalled exhaust clamp being brought up to the corresponding pipe.

**Arrow B** shows the overlapping pipe installed correctly over the corresponding pipe.

**Arrow C** shows the exhaust band clamp being brought to the edge of the expanded pipe.



### NOTES:

- **Do not** fully torque any exhaust clamp until the entire exhaust has been installed and adjusted.
- Torque specification is a **minimum** of 60 ft/lbs

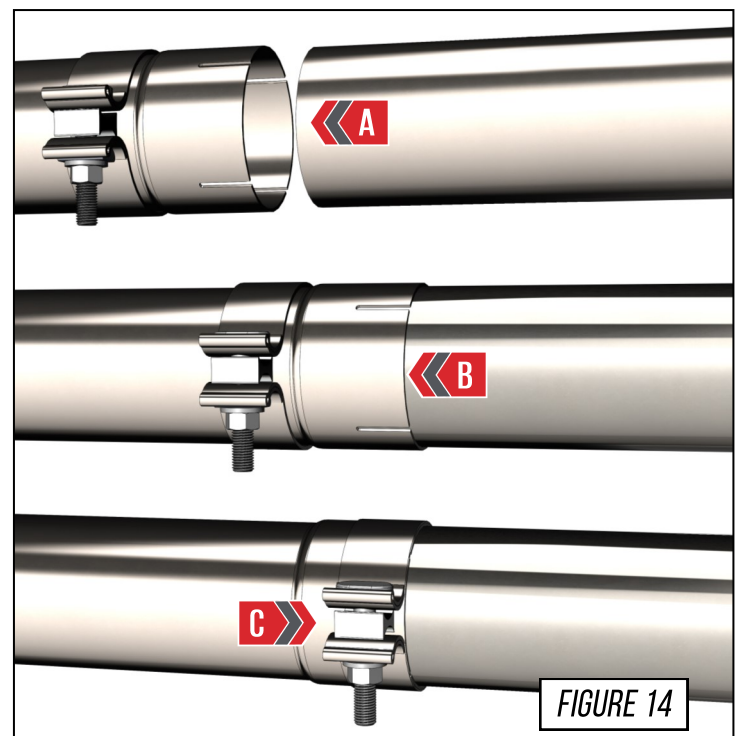
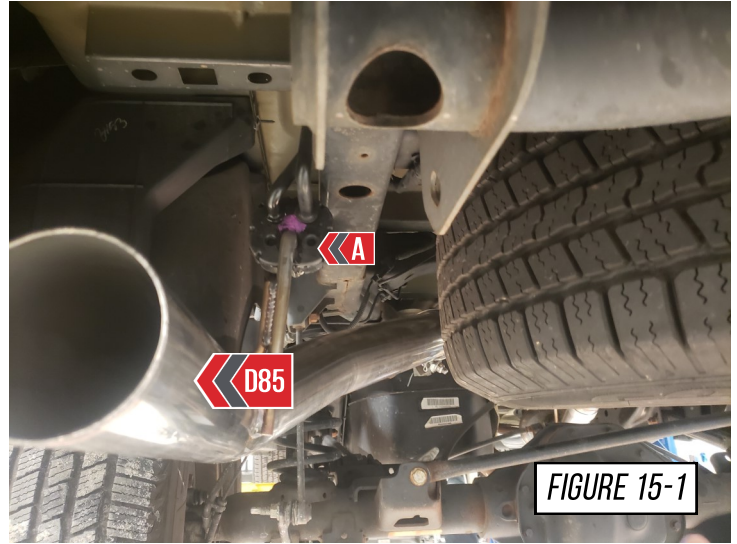

FIGURE 14

## STEP 15

Next install the AWE rear exit dual driver side tube (D85/D87) by simultaneously putting the hanger bar into the OE hanger, shown at (A) in **Figure 15-1**, While lining up the inlet of the AWE driver side rear exit tube with the AWE driver side over axle tube.

Snug the clamp on the AWE rear dual exit driver side tube (D85/D87), as shown at (B) in **Figure 15-2**. It is important to only snug the clamp as adjustments may be required for final tip fitment.



## STEP 16

To finish the AWE rear exit sections install, place a lock collar on the hanger bars, as shown in **Figure 16**.

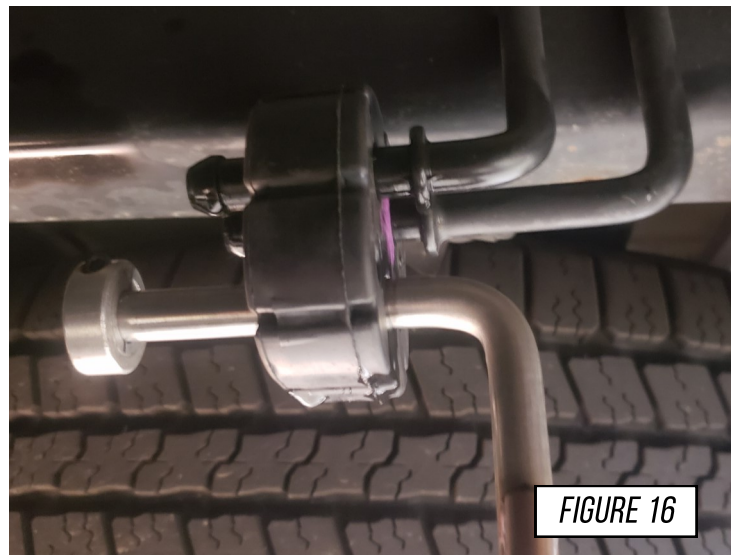



STEPS 17-20 APPLY ONLY TO TRUCKS WITH BUMPER CUTOUTS



## STEP 17

Next install the AWE tip outlet sections (**E23**) on the driver and passenger side rear exit tubes (**D85/D86**). Place the tube outlets onto the ball socket and tighten so they are held in place but can still move easily for adjustment, as seen in **Figure 17-1** and **Figure 17-2**.



**Note:** Do not use an impact gun when tightening the clamp on the ball socket.

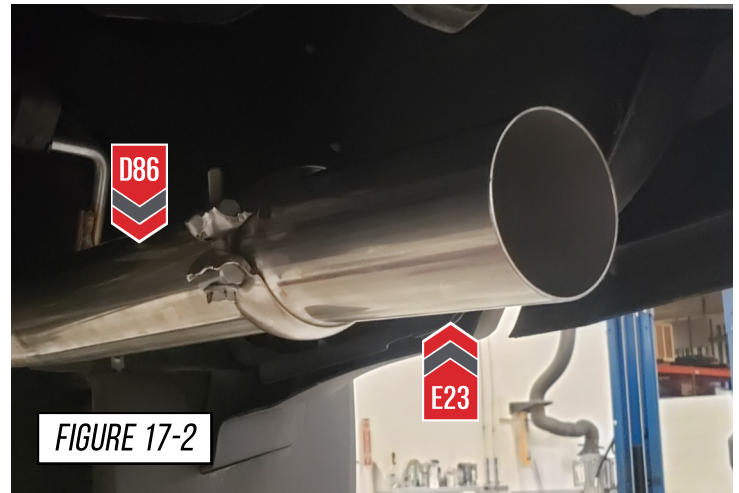

## STEP 18

Install your AWE tips and leave the clamps loose to allow for adjustment, as shown in **Figure 18-1**, and **Figure 18-2**.



**Note:** Do not use an impact gun when tightening the clamp on the tip.

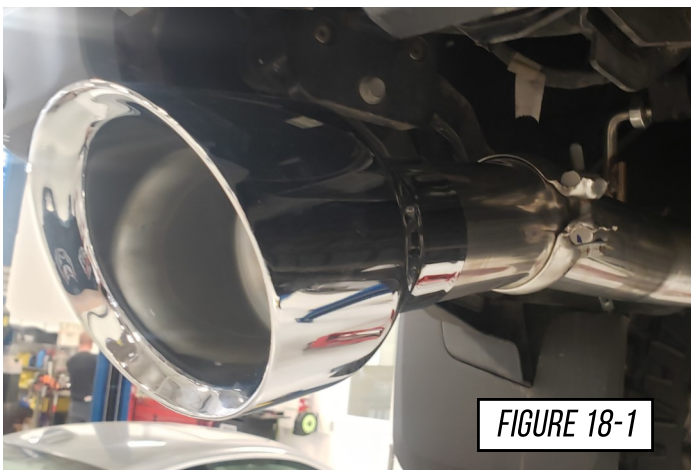

## STEP 19

To install the exhaust tips with integrated clamps, first, attach the exhaust tip in the proper orientation onto the exhaust outlet tube.

Insert one of the carriage bolts from the hardware kit (**3910-41010**) through the tab on the exhaust tip and thread on one of the corresponding nuts.

Using anti-seize on the bolt threads will help installation and prevent breakage of hardware.

 This exhaust system only has 2 exhaust tips while the integrated clamp kit has enough hardware for our 4 tip exhaust systems. You will have 2 sets of hardware left over that will not be used.

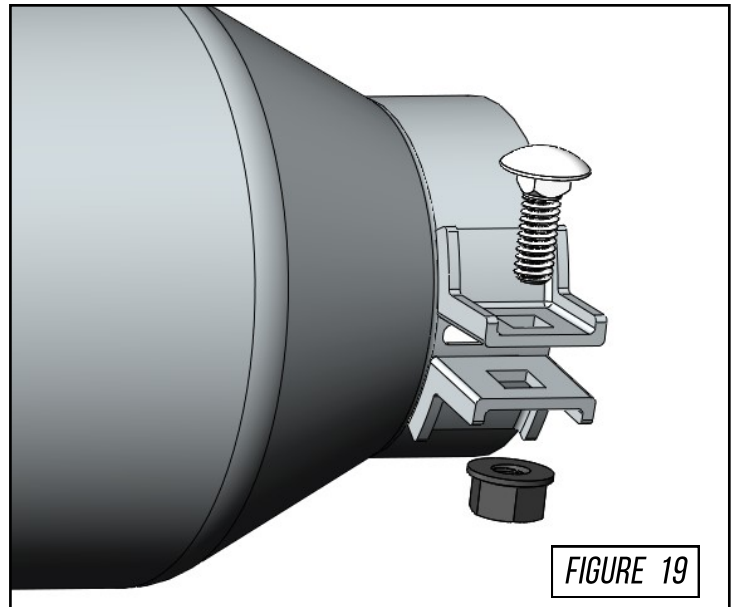

## STEP 20

Lastly, make any adjustments required to space the tips evenly. This may vary from vehicle to vehicle. Make adjustments by rotating the tubes at the joints.

Once your desired tip location is achieved, be sure to fully tighten all clamps starting from front to back before concluding installation.



# ENJOY!





## STEPS 21-22 ONLY APPLY TO FLAT BUMPER TRUCKS



### STEP 21

Install your AWE tips onto the rear exit tubes and snug the clamps in place, as shown in **Figure 20-1**, and **Figure 20-2**.



FIGURE 21-1

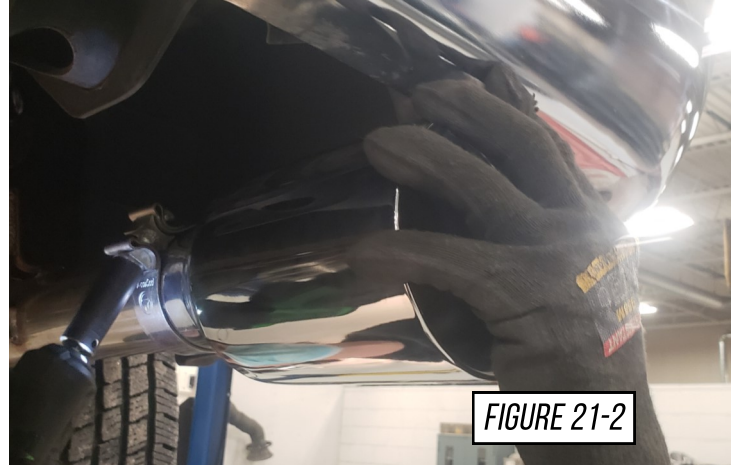

FIGURE 21-2

### STEP 22

Lastly, make any adjustments required to space the tips evenly. This may vary from vehicle to vehicle. Make adjustments by rotating the tubes at the joints.

Once your desired tip location is achieved, be sure to fully tighten all clamps, it is important to start from the front and work your way back when tightening the clamps.



## ENJOY!



## STEPS 23-24 ARE FOR BASH GUARD INSTALLATION ONLY



### STEP 23

Slide one of the provided clamp onto the AWE drivers side over axle tube.

Install your AWE Bash Guard onto the over axle tube, making sure it is bottomed out fully.

Tighten the clamp over the AWE bash guard, as shown in **Figure 23**.

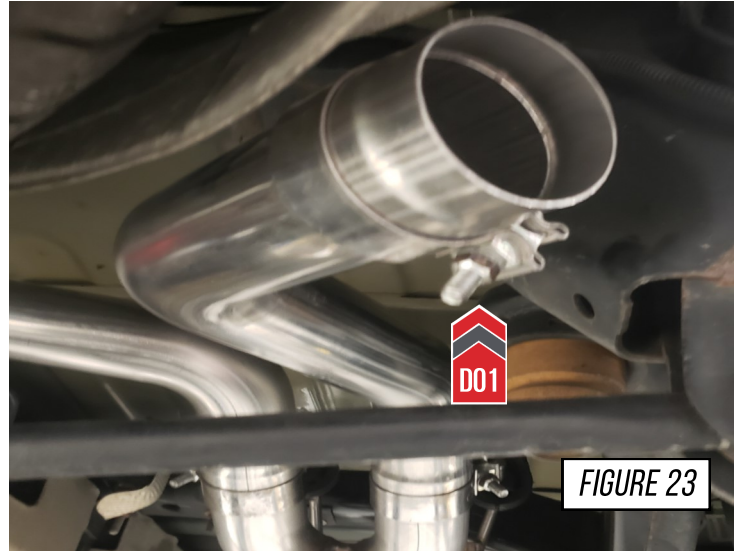

### STEP 24

Slide one provided clamp onto the AWE passengers side over axle tube.

Install your AWE Bash Guard onto the over axle tube, making sure it is bottomed out fully.

Tighten the clamp over the AWE bash guard, as shown in **Figure 24**.

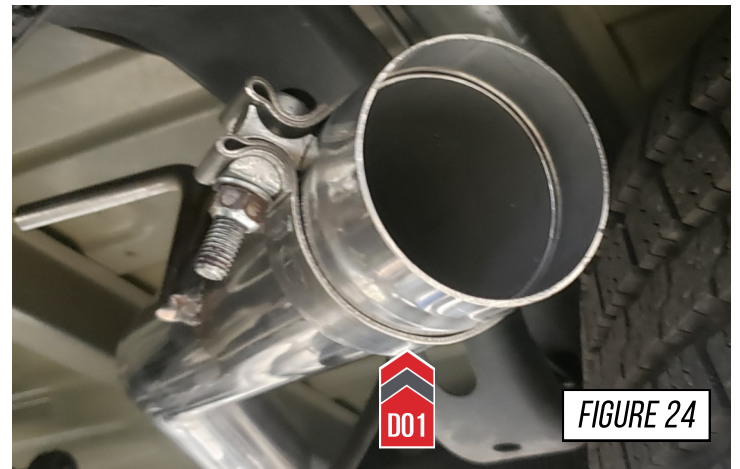

**ENJOY!**





## STEP 25

Slide a clamp over the outlet of your AWE inlet section (D78) and install your AWE single side midpipe (D79), as shown in **Figure 25**.

Ensure the AWE single side midpipe is bottomed out on the inlet section. Snug the clamp to allow for adjustments.



**Note:** If you are installing your AWE Bash Guard, slide a clamp onto the midpipe and bottom out the Bash guard on the midpipe, then tighten the clamp.



## STEP 26

Install your AWE tip outlet section by sliding the hanger bar into the hanger shown at (A) in **Figure 26**.

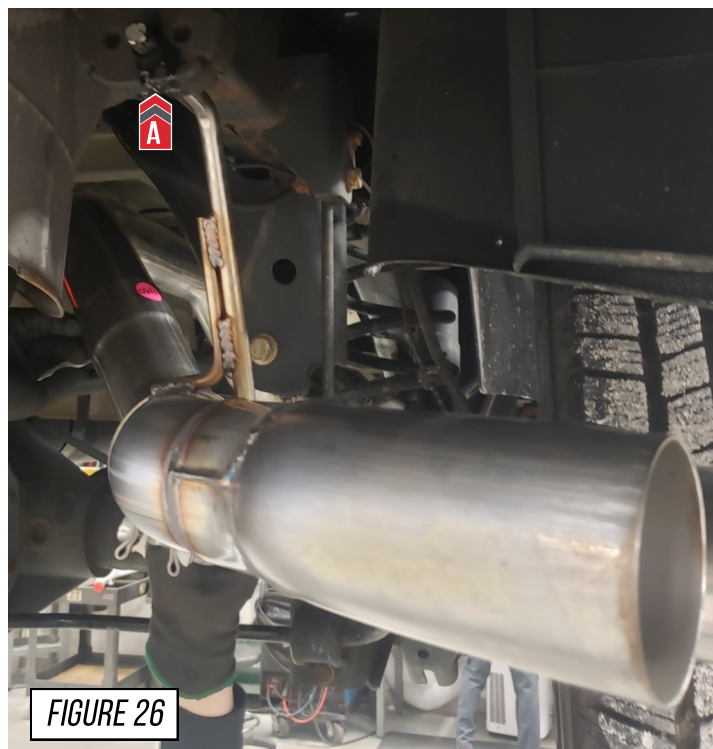

## STEP 27

Next bottom out your AWE tip section (**D80**) on the midpipe and snug the clamp to allow for adjustment, as shown in **Figure 27**.



FIGURE 27

## STEP 28

It is crucial to install each section and exhaust band clamps correctly to prevent loose joints, exhaust leaks and rattles.

**Arrow A** shows the expanded pipe and the preinstalled exhaust clamp being brought up to the corresponding pipe.

**Arrow B** shows the overlapping pipe installed correctly over the corresponding pipe.

**Arrow C** shows the exhaust band clamp being brought to the edge of the expanded pipe.



### NOTES:

- **Do not** fully torque any exhaust clamp until the entire exhaust has been installed and adjusted.
- Torque specification is a **minimum** of 60 ft/lbs

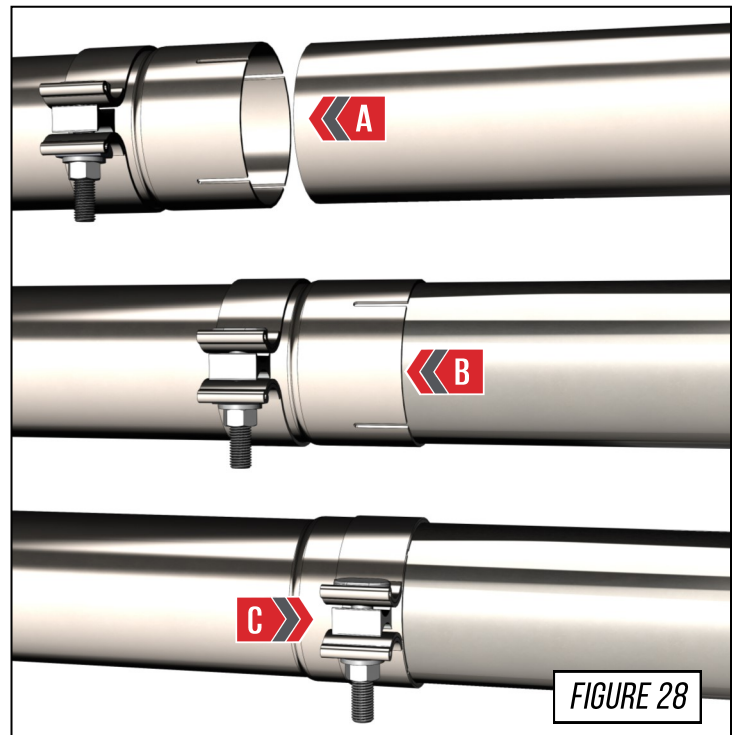

FIGURE 28

## STEP 29

For the best tip fitment, align the barrel style tip clamp to cover *only* the slot, shown by **Arrow A**

Torque the tip clamp to 18 ft./lbs.



### NOTES:

- It is required to apply anti-seize to the threads to prevent thread binding, shown by **Arrow B**
- It is okay to have the clamp extend beyond the edge of the tip inlet.

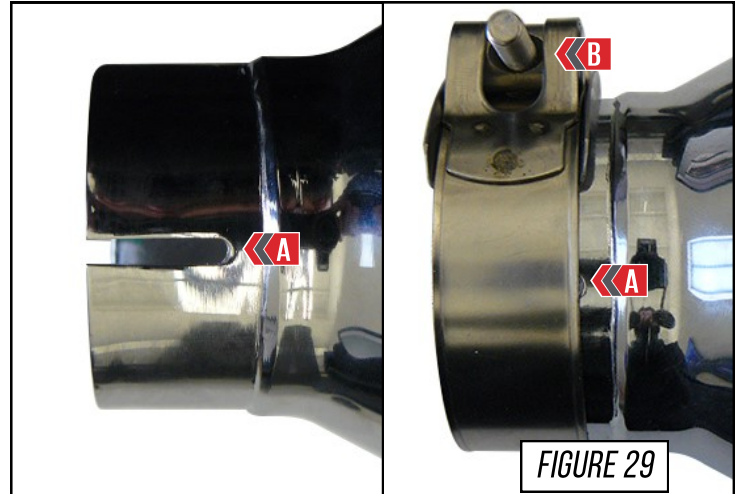

## STEP 30

Install your AWE tips and snug the clamps, as shown in **Figure 30**.

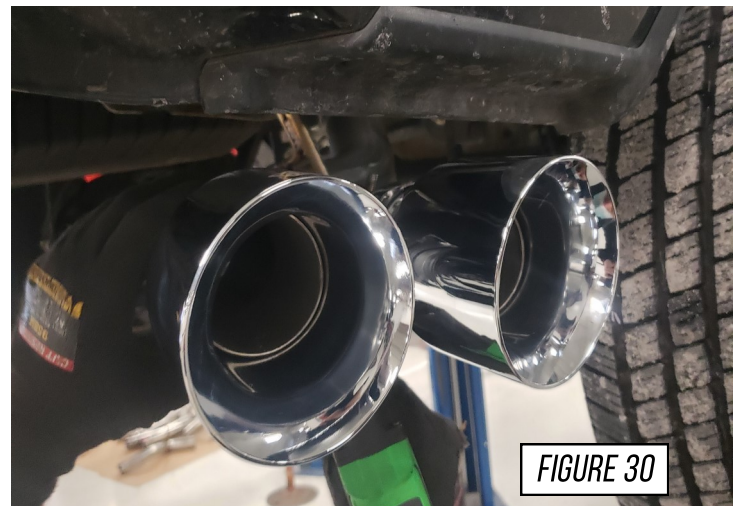

## STEP 31

Adjust the system so the tips are parallel with the bumper line of the truck, as shown in **Figure 31**.

When the desired tip location is achieved, tighten all clamps starting from the front of the vehicle and work towards the back.

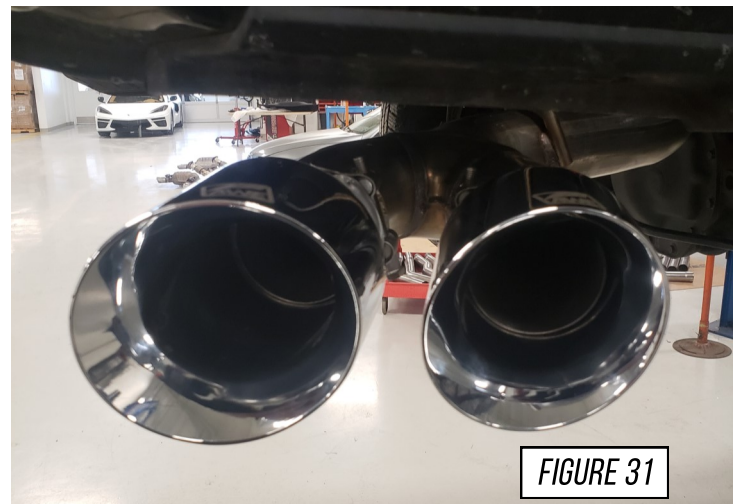

# ENJOY!



## TROUBLESHOOTING

Issue	Solution
Exhaust is not fitting correctly	Most fitment issues are due to improperly adjusted exhaust. This includes tip fitments and rattling due to chassis contact. Check out our <a href="#">fitment guide</a> for more installation tips.
Wrong or missing parts	Double check the parts list for your system and compare them with what you received. Fill out our contact form, found below and let us know what parts you need.

## CARE

Once installed properly, your AWE exhaust will provide years of trouble-free performance.

The exhaust volume and sound will settle with usage; 800-1000 miles is required to break-in new exhaust systems.

Also, please note that the rear **180Technology®** resonator has a small drain hole to allow condensation to escape. Water drops from this area are normal.

Periodic cleaning of exhaust tips is necessary to maintain proper finish, especially in areas prone to road salt and caustic deicing solutions. Use a mild soap and water solution or car wax to clean the finish. Avoid using abrasive polishes, as they can scratch the finish.

Any questions or comments,  
please do not hesitate to contact us:

**AWE**  
199 Precision Drive  
Horsham, PA 19044  
215-658-1670  
[CONTACT FORM](#)

## WARRANTY

Up-to-date warranty information is found [HERE](#).