



INSTALLATION GUIDE: **AWE TRACK and TOURING Dodge Challenger Exhaust**

For up-to-date fitment information, please visit the product page on [AWE-Tuning.com](https://www.awe-tuning.com).

THIS GUIDE IS INTENDED FOR THE FOLLOWING PART NUMBERS:

3015-42144 AWE Track Edition Exhaust for Challenger 5.7L - Chrome Silver Quad Tips

3015-43152 AWE Track Edition Exhaust for Challenger 5.7L - Diamond Black Quad Tips

3020-42076 AWE Touring Edition Exhaust for Challenger 5.7L - Non-Resonated - Chrome Silver Quad Tips

3020-43084 AWE Touring Edition Exhaust for Challenger 5.7L - Non-Resonated - Diamond Black Quad Tips

Welcome to the AWE family, and congratulations on your purchase of the AWE Exhaust system for the Challenger.

Exquisite build quality and craftsmanship, coupled with industry leading performance, distinguish this exhaust system from all others.

*For up to the minute fitment information, be sure to visit the AWE website. As always, AWE Performance Specialists are standing by for any questions, [right here](#).

PARTS LIST



INSPECT ALL PARTS PRIOR TO DISASSEMBLY OF VEHICLE; IF DAMAGED OR MISSING, PLEASE CONTACT THE PLACE OF PURCHASE IMMEDIATELY.

Dodge Challenger Exhaust

- 1 H pipe
- 1 DS resonated axle tube
- 1 PS resonated axle tube
- 1 DS non resonated axle tube
- 1 PS non resonated axle tube

- C96 - (All)
- C62 - (Track or Touring)
- C63 - (Track or Touring)
- C60 - (Touring)
- C61 - (Touring)

Stock Tip Option

- 1 DS track OEM tip
- 1 PS track OEM tip
- 1 DS touring OEM tip
- 1 PS touring OEM tip

- C66
- C67
- C64
- C65

Quad Tip Option

- 1 DS touring quad tip
- 1 PS touring quad tip
- 1 DS track quad tip
- 1 PS track quad tip
- 4 3.5in tip
- 4 Tip clamp

- C68
- C69
- C83
- C84
- 31122242 (silver) or 31122243 (black)
- BHM6X063SS00C

Exhaust Hardware

- 2 2.50in exhaust clamp
- 4 3.0in exhaust clamp
- 5 7.5in cable tie

- 390250
- 390300
- 7130K59

Valve Simulator

- 2 7/64" diameter steel dowel
- 2 Kuster valve motor simulator
- 6 Flange head screw 8-32 x 5/8"

- 98380A457
- 150005
- 92323A593

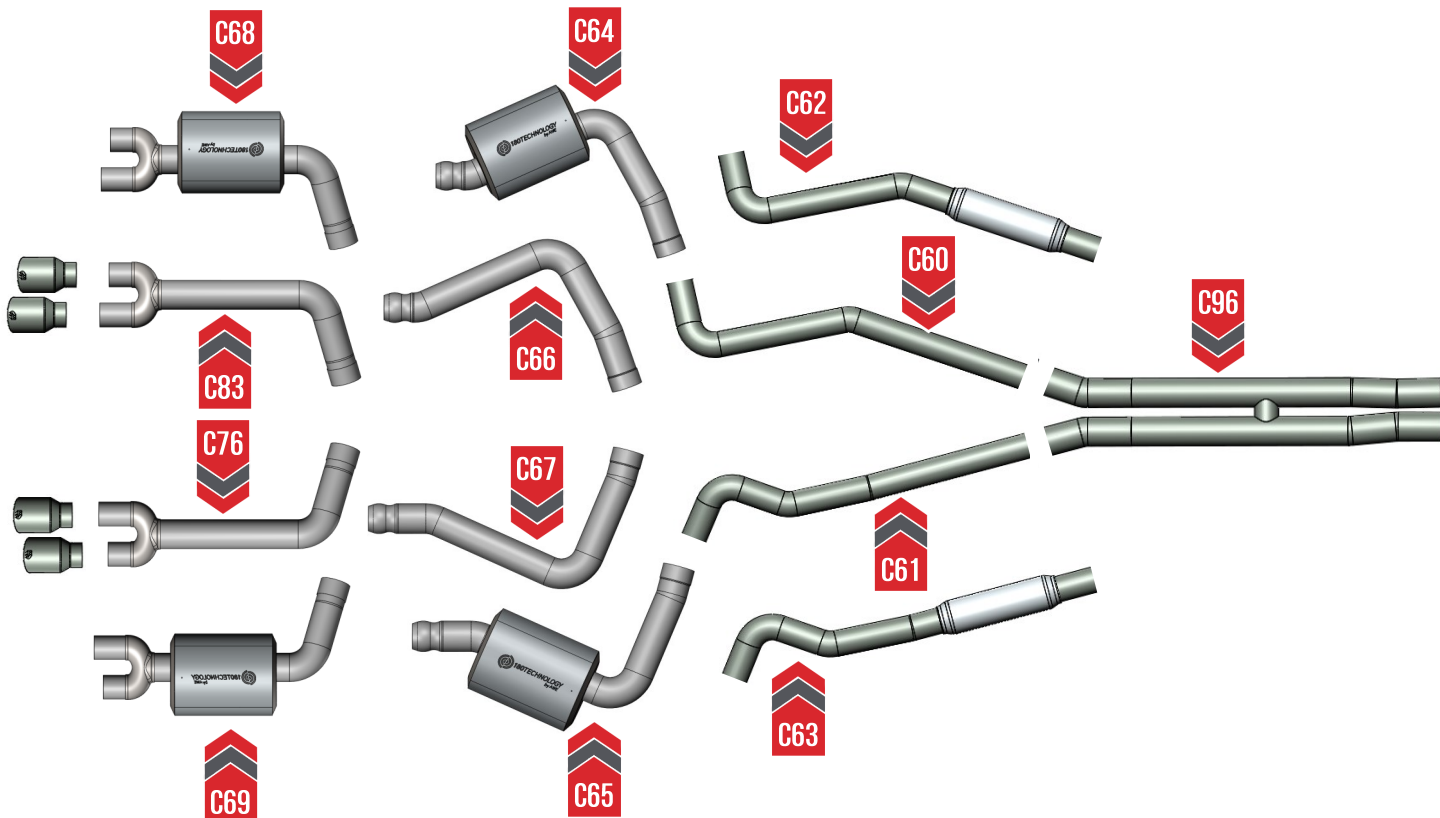

 **NOTE:** Always refer to the manufacturer's service manual for precise torque specifications on all OEM fasteners.

 **CAUTION:** The exhaust may be **VERY HOT** — allow adequate time for the system to cool down before disassembly. Severe burns and injury will occur if skin comes into contact with a hot exhaust system.

STEP 1

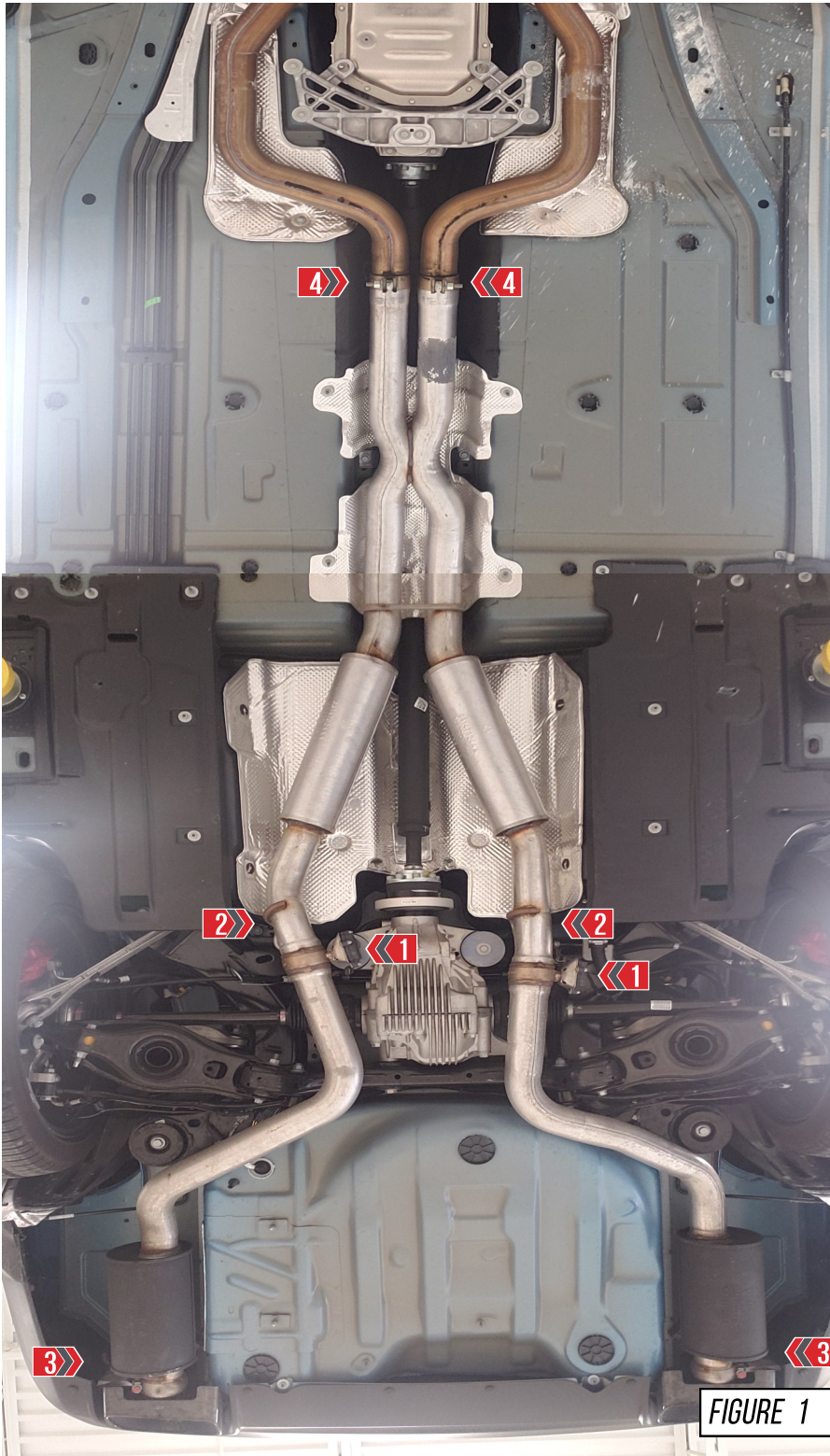

Start by removing the OEM Challenger exhaust by following these steps, shown in **Figure 1**.

1. Un plug the 2 valve motors from the OEM harness.
2. Remove the 1 bolt per side holding the mid hangers in place, these 2 hangers have a hook that will hold the weight of the exhaust for the rest of the removal.
3. Remove the 1 bolt per side holding the 2 rear hangers to the chassis and the ground strap.
4. Loosen the 2 OEM clamps to allow you to remove the exhaust.

NOTE: The exhaust may take force or rotation to remove it from the OEM down pipes.

NOTE: All 4 rubber OEM exhaust hangers will be used with your AWE exhaust. Do not mix up the original locations of the 4 hangers.

FIGURE 1

STEP 2

Start installing your AWE exhaust by placing 2 of the provided exhaust clamps onto the OEM down pipe side of the H-pipe as shown in **Figure 2-1**. Install the H-pipe onto the OEM down pipes, this may require extra force, an option is to use a block of wood and a hammer to fully seat the exhaust onto the down pipes, as shown in **Figure 2-2**.

Note: The DS of the H-pipe contains a tag to ensure correct alignment.

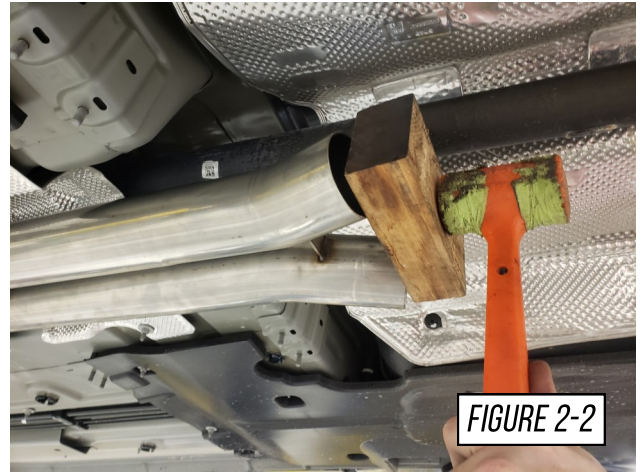
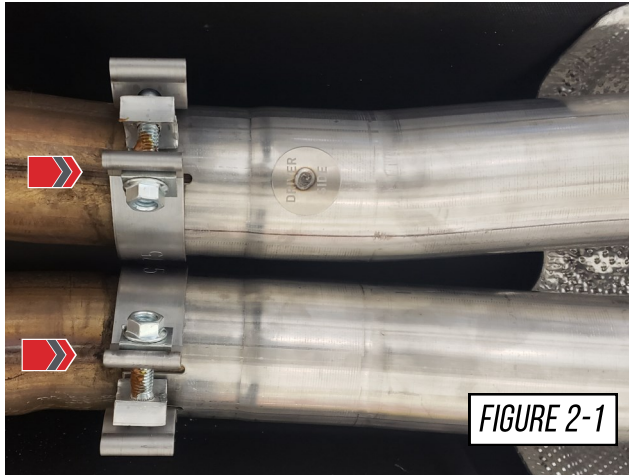

STEP 3

Install the axle sections of your AWE exhaust using 2 of the provided exhaust clamps. Slip the tubes onto the H-pipe. With the OEM hangers you removed earlier installed, rotate the OEM mount into place and reinstall the OEM bolts, as shown in **Figure 3**.

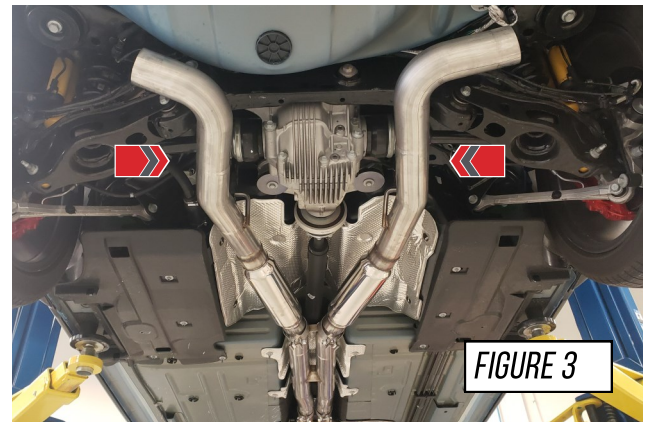

STEP 4

Install the OEM hangers onto your AWE tip section of the exhaust, as shown in **Figure 4**.

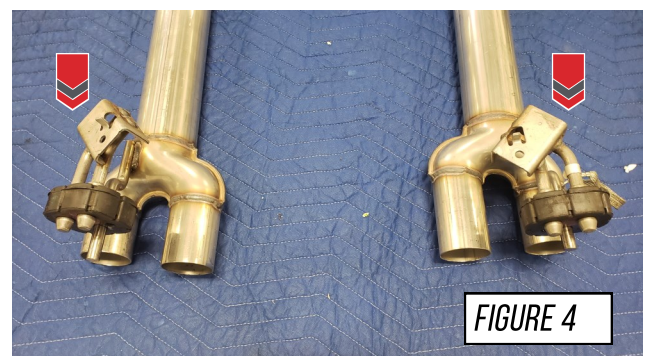

STEP 5

Install the tip sections of your AWE exhaust using 2 of the supplied exhaust clamps and the OEM hangers reinstated in the OE locations, as shown in **Figure 5**.

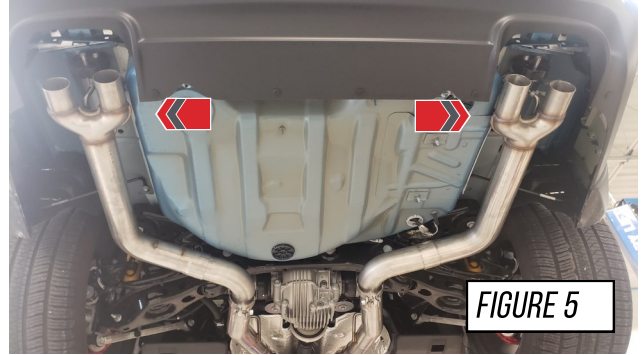

STEP 6

It is crucial to install each section and Accu-Seal clamp correctly to prevent loose joints, exhaust leaks between the tubing connections and rattles.

Arrow A in **Figure 6** shows the expanded pipe and the preinstalled Accu-Seal clamp being brought up to the corresponding pipe.

Arrow B in **Figure 6** shows the overlapping pipe installed correctly over the corresponding pipe.

Arrow C in **Figure 6** shows the Accu-Seal clamp being brought to the edge of the expanded pipe.

NOTES:



- **Do not** torque any Accu-Seal clamp until the entire exhaust has been installed and adjusted.
- Torque specification is a **minimum** of 60 ft/lbs

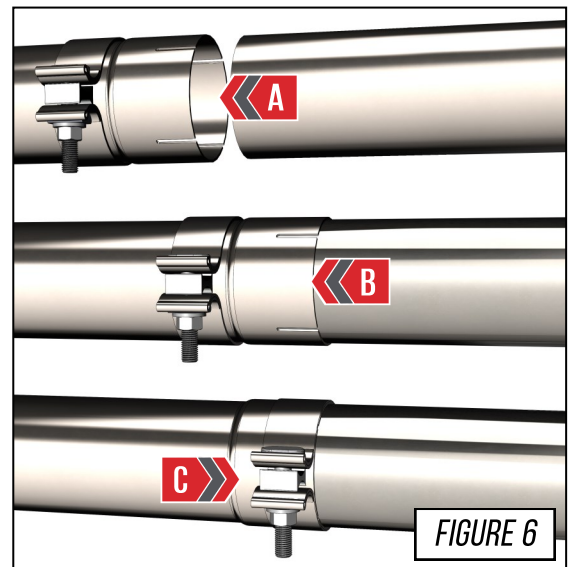

STEP 7

Install the exhaust tips onto your AWE exhaust, at this time snug the tip clamps, not fully tightening yet.

AWE Quad tips, will use the supplied clamps and tips, as shown in **Figure 7**.

Stock tips, will use the stock tip and barrel clamp.



Use anti-seize in the threads of the clamps.



STEP 8

To accomplish the best tip fitment, align the 2.5" tip clamp to cover *only* the slot, as shown by **Arrow A** in **Figure 8**.

The clamp should only be covering the section of the tip that has been slotted, as shown by **Arrow B** in **Figure 8**.



Torque the tip clamp to a **minimum** of 18 ft./lbs.

NOTES:

- It is required to apply anti-seize to the threads to prevent thread binding, shown by **Arrow C** in **Figure 8**.
- It is okay to have the clamp extend beyond the edge of the tip inlet.

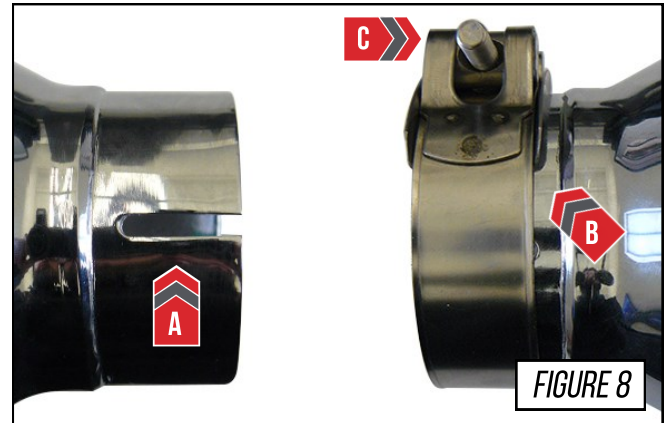

STEP 9

Check over your AWE exhaust for proper clearance from the chassis and correct tip alignment, working from the front to the back, ensure you torqued all the exhaust clamps to at least 60ft-lbs, and the tips are torqued to at least 18ft-lbs.

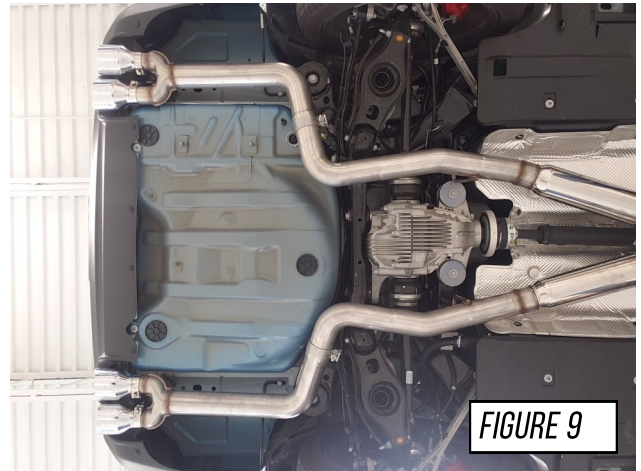

STEP 10

Remove the 2 valve motors from the OEM exhaust, next remove the OEM spring, shown by **Arrow A**, and install the supplied small dowel, shown by **Arrow B**.

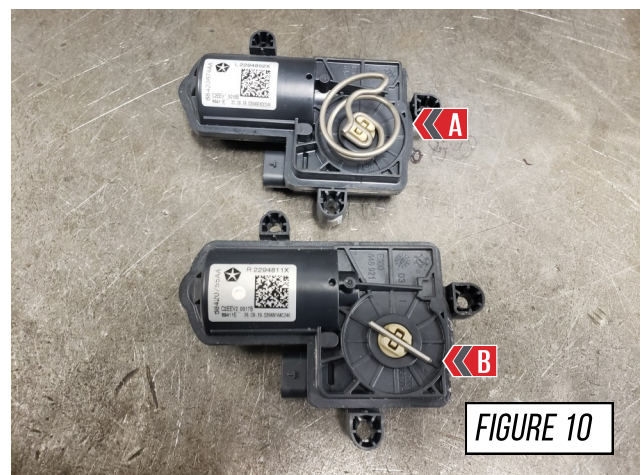

STEP 11

With the dowels attached to the 2 valve motors, gather the supplied brackets and bolts, as shown in **Figure 11-1**. Attach the valve motors to the brackets, as shown in **Figure 11-2**.

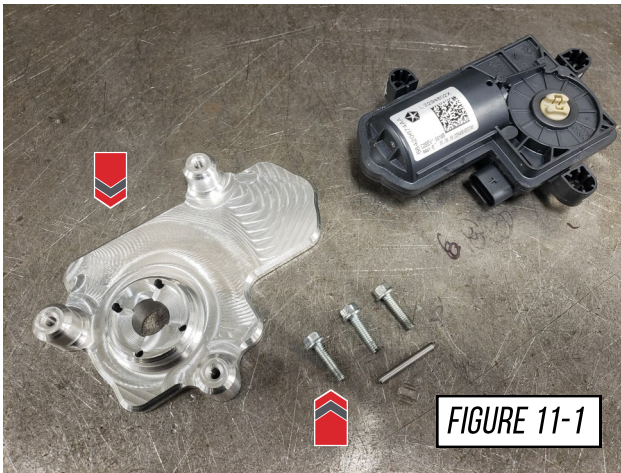

FIGURE 11-1

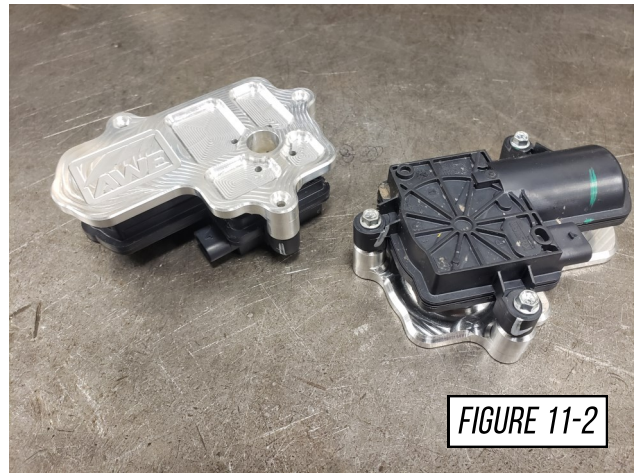

FIGURE 11-2

STEP 12

With the valve motor attached to the bracket, plug the motor back into the OEM wiring harness and using 4 of the supplied cable ties, 2 for each, secure the valve motors out of the way of any moving parts, as shown in **Figure 12-1** and **12-2**.

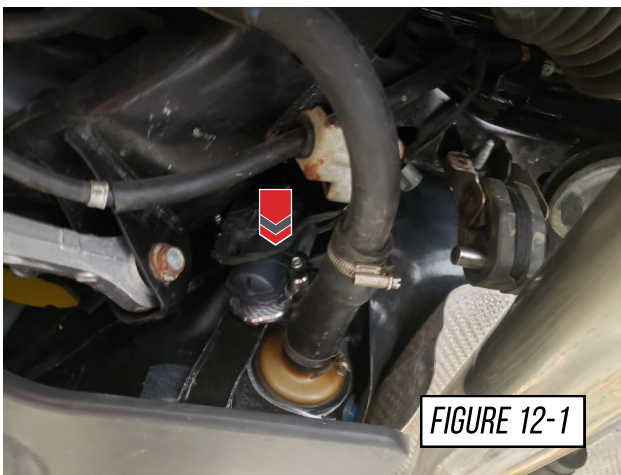

FIGURE 12-1

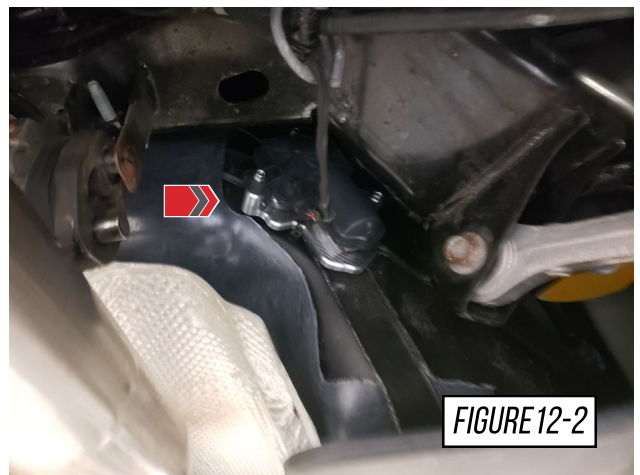

FIGURE 12-2

STEP 13

Use a supplied cable tie to secure the wire loom coming out of the passenger side trunk area away from the exhaust as shown in **Figure 13**.

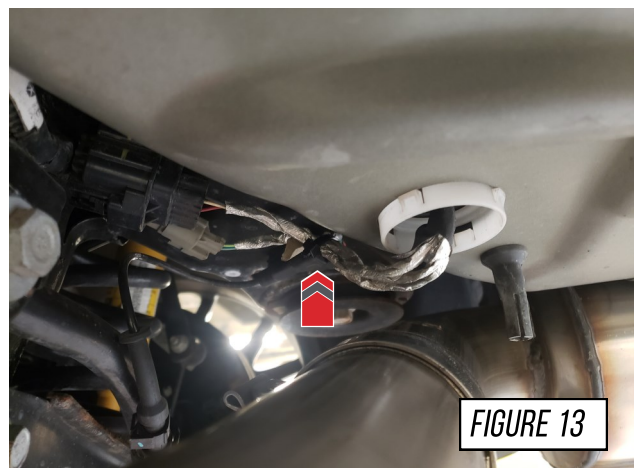
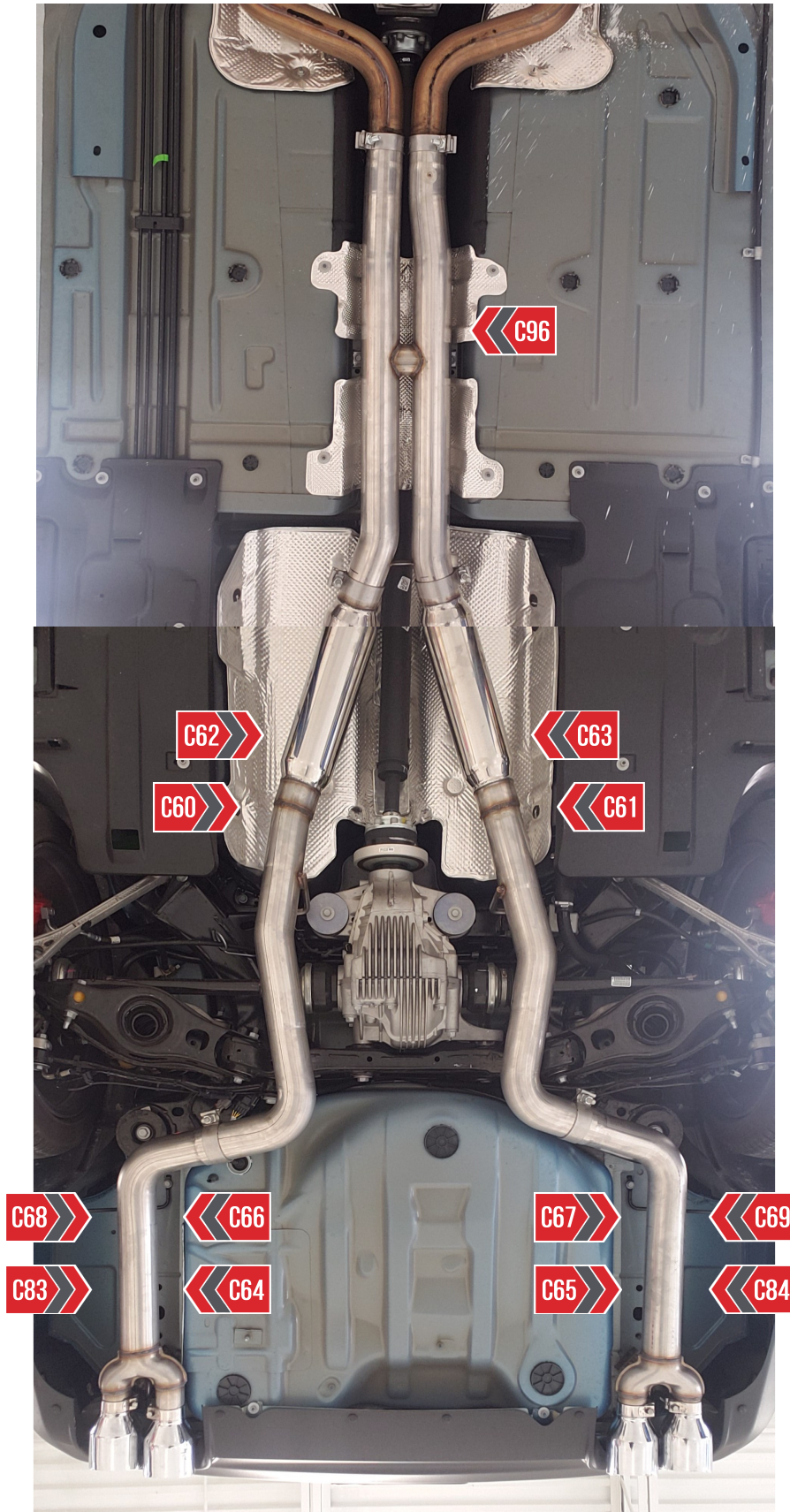

FIGURE 13

STEP 14



ENJOY!



TROUBLESHOOTING

Issue	Solution
Exhaust is not fitting correctly	Most fitment issues are due to improperly adjusted exhaust. This includes tip fitments and rattling due to chassis contact. Check out our fitment guide for more installation tips.
Wrong or missing parts	Double check the parts list for your system and compare them with what you received. Fill out our contact form, found below and let us know what parts you need.
Clamps wont tighten	Ensure you have the right clamps using the description on the parts page. Use anti-seize on the threads and tighten to at least 60 ft-lbs. If you have a broken or incorrect clamp, please visit clamp corner.

CARE

Once installed properly, your AWE exhaust will provide years of trouble-free performance.

The exhaust volume and sound will settle with usage; 800-1000 miles is required to break-in new exhaust systems.

Also, please note that the rear **180Technology®** resonator has a small drain hole to allow condensation to escape. Water drops from this area are normal.

Periodic cleaning of exhaust tips is necessary to maintain proper finish, especially in areas prone to road salt and caustic deicing solutions. Use a mild soap and water solution or car wax to clean the finish. Avoid using abrasive polishes, as they can scratch the finish.

Any questions or comments,
please do not hesitate to contact us:

AWE
215-658-1670
[CONTACT FORM](#)

WARRANTY

Up-to-date warranty information is found [HERE](#).