



INSTALLATION GUIDE:

AWE Jeep Grand Cherokee SRT and Trackhawk

THIS PRODUCT IS INTENDED FOR THE FOLLOWING VEHICLES*:

YEAR	MAKE	MODEL	SUBMODEL	ENGINE
2018-2020	Jeep	Grand Cherokee	SRT	6.4L
2018-2020	Jeep	Grand Cherokee	Trackhawk	6.2L

THIS GUIDE IS INTENDED FOR THE FOLLOWING PART NUMBERS:

3020-31023	AWE Track Edition Exhaust for Jeep Grand Cherokee SRT and Trackhawk - for use with stock tips
3015-31017	AWE Touring Edition Exhaust for Jeep Grand Cherokee SRT and Trackhawk - for use with stock tips
3020-32061	AWE Track Edition Exhaust for Jeep Grand Cherokee SRT - Chrome Silver Tips
3015-32123	AWE Touring Edition Exhaust for Jeep Grand Cherokee SRT - Chrome Silver Tips
3020-33051	AWE Track Edition Exhaust for Jeep Grand Cherokee SRT - Diamond Black Tips
3015-33121	AWE Touring Edition Exhaust for Jeep Grand Cherokee SRT - Diamond Black Tips

Welcome to the AWE family, and congratulations on your purchase of the AWE Exhaust system for the Trackhawk.

Exquisite build quality and craftsmanship, coupled with industry leading performance, distinguish this exhaust system from all others.

*For up to the minute fitment information, be sure to visit the AWE website. As always, AWE Performance Specialists are standing by for any questions, [right here](#).

PARTS LIST (OE TIP SYSTEMS)



INSPECT ALL PARTS PRIOR TO DISASSEMBLY OF VEHICLE; IF DAMAGED OR MISSING, PLEASE CONTACT THE PLACE OF PURCHASE IMMEDIATELY.

Symbol	Part Number	Description	QTY
OE Tip Systems Only			
	C85	Jeep SRT8/Trackhawk WK2 resonated H-pipe	1
	C86	Jeep SRT8/Trackhawk WK2 DS axle tube	1
	C87	Jeep SRT8/Trackhawk WK2 PS axle tube	1
	98093A648	Black-phosphate class 10.9 steel screw, flanged hex head, M10 x 1.50mm, 90mm long	4
	390300	3 Inch SS smart seal band clamp	4
	3910-41010	Hardware kit for integrated clamp style exhaust tips	1
	3910-11012	AWE 1/2" split collar clamp kit: includes 9/64 allen wrench and two 1/2" collar clamps	1
Track Systems Only			
	C90	Jeep SRT8/Trackhawk WK2 DS track rear OEM tip	1
	C91	Jeep SRT8/Trackhawk WK2 PS track rear OEM tip	1
Touring Systems Only			
	C88	Jeep SRT8/Trackhawk WK2 DS touring rear OEM tip	1
	C89	Jeep SRT8/Trackhawk WK2 PS touring rear OEM tip	1

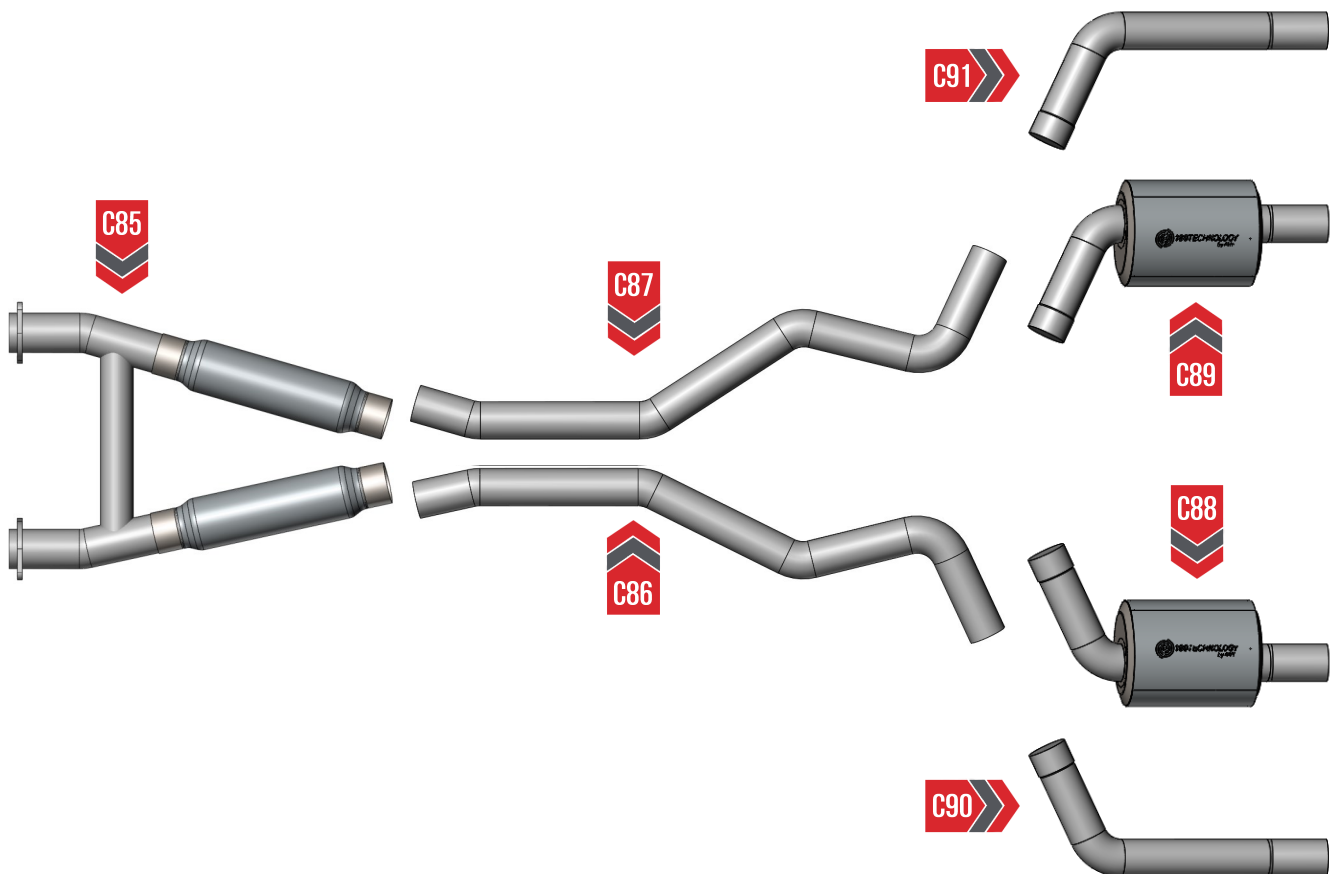

PARTS LIST (AWE TIP SYSTEMS)



INSPECT ALL PARTS PRIOR TO DISASSEMBLY OF VEHICLE; IF DAMAGED OR MISSING, PLEASE CONTACT THE PLACE OF PURCHASE IMMEDIATELY.

Symbol	Part Number	Description	QTY
OE Tip Systems Only			
	C85	Jeep SRT8/Trackhawk WK2 resonated H-pipe	1
	C86	Jeep SRT8/Trackhawk WK2 DS axle tube	1
	C87	Jeep SRT8/Trackhawk WK2 PS axle tube	1
	98093A648	Black-phosphate class 10.9 steel screw, flanged hex head, M10 x 1.50mm, 90mm long	4
	390300	3 inch SS smart seal band clamp	4
	3910-41010	Hardware kit for integrated clamp style exhaust tips	1
	3910-11012	AWE 1/2" split collar clamp kit: includes 9/64 allen wrench and two 1/2" collar clamps	1
Track Systems Only			
	D04	Jeep (SRT8 only) WK2 DS track rear AWE 5" tip	1
	D05	Jeep (SRT8 only) WK2 PS track rear AWE 5" tip	1
Touring Systems Only			
	D02	Jeep (SRT8 only) WK2 DS touring rear AWE 5" tip	1
	D03	Jeep (SRT8 only) WK2 PS touring rear AWE 5" tip	1
Chrome Tips Only			
	180006	AWE chrome 5" slash cut tip	2
Black Tips Only			
	180007	AWE black chrome 5" slash cut tip	2

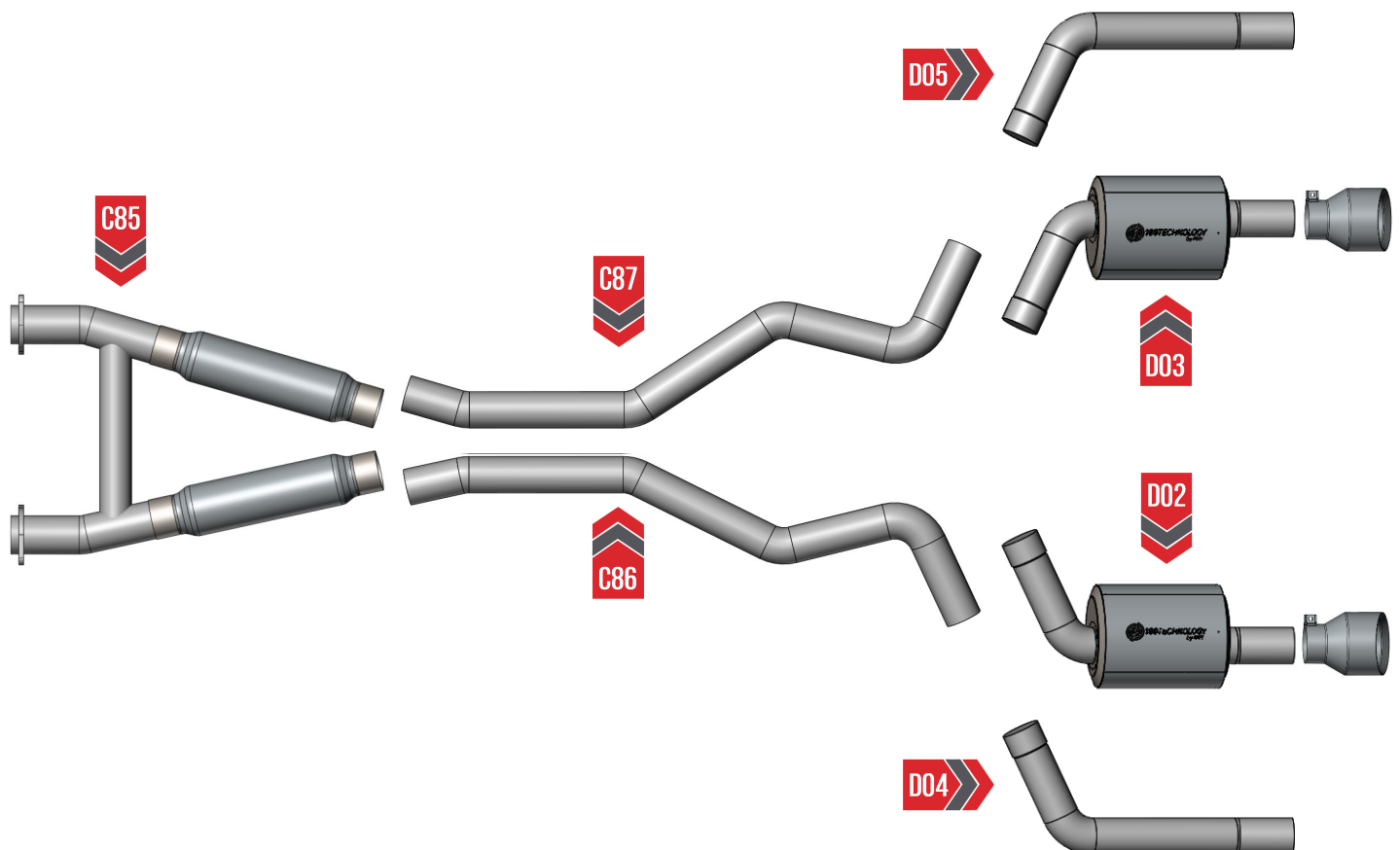



NOTE: Always refer to the manufacturer's service manual for precise torque specifications on all OEM fasteners.



CAUTION: The exhaust may be **VERY HOT** — allow adequate time for the system to cool down before disassembly. Severe burns and injury will occur if skin comes into contact with a hot exhaust system.

STEP 1

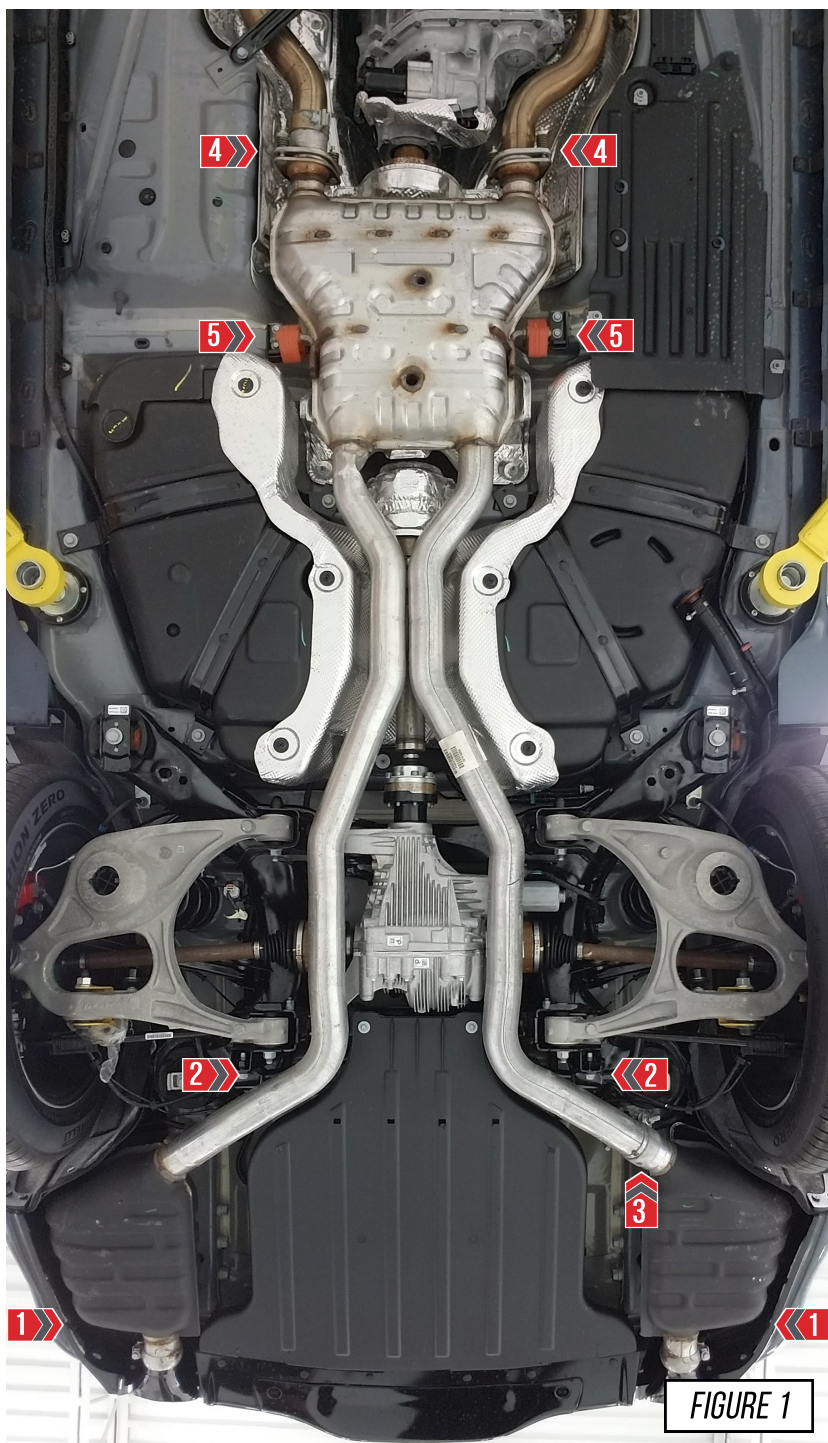

FIGURE 1

Start by removing the OEM Cherokee exhaust by following these steps, shown in **Figure 1**.

1. Remove the 2 OEM rear hangers above the mufflers.
2. Remove the 2 OEM axle hangers.
3. Loosen the exhaust clamp, now you will be able to carefully remove the passenger side muffler from the vehicle.
4. Remove the OEM hardware on both flanges.
5. Remove the 2 bolts per side holding the front exhaust hangers in place.
6. Remove the OEM exhaust from the vehicle.

NOTE: The PS muffler may take force or rotation to remove it from the OEM exhaust.

NOTE: All 6 rubber OEM exhaust hangers will be used with your AWE exhaust. Do not mix up the original locations of the 6 hangers.

STEP 2

Start installing your AWE exhaust by placing the 2 OEM hangers onto the H-pipe, as shown in **Figure 2-1**. Install the H-pipe onto the OEM down pipes, using the bent hanger bar pointing up (**A**) as a guide for correct alignment, next place 2 of the provided exhaust clamps (**B**), as shown in **Figure 2-2**.

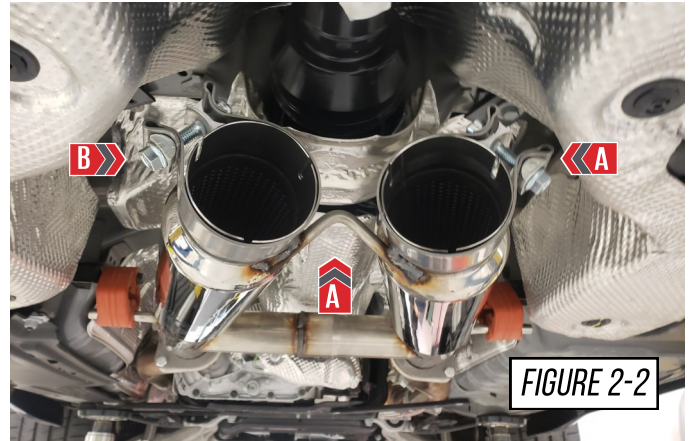
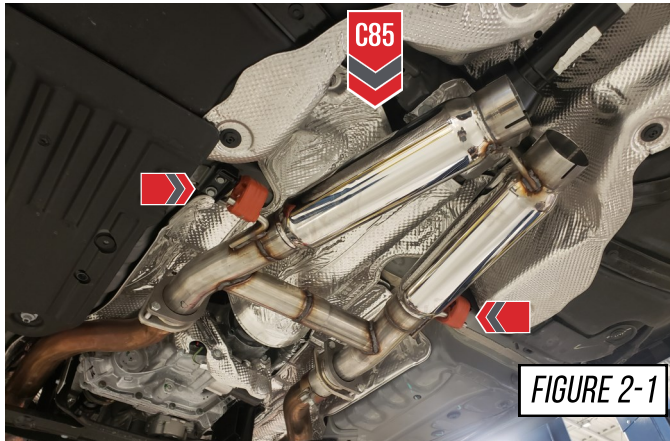

STEP 3

The flange is connected using the 2 per side, supplied bolts and the 2 per side, OEM springs and flange nuts.

 The bolts are properly tightened when the flange nut is bottomed out on the bolt. Over tightening the bolt will strip it out.

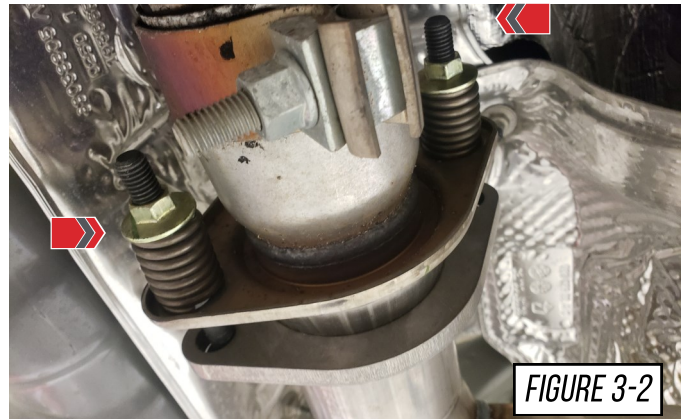
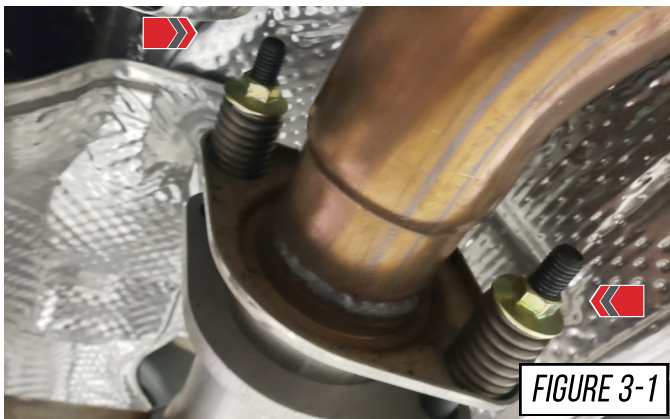

STEP 4

Gather the 2 AWE axle tubes. Note the passenger (**C87**) tube has a longer straight section at the end, as shown in **Figure 4**.

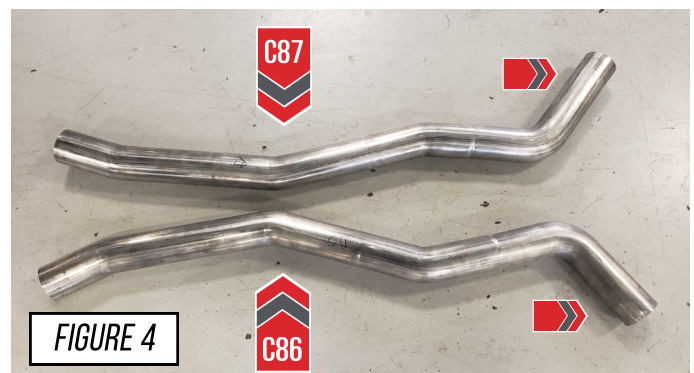

STEP 5

It is crucial to install each section and exhaust band clamps correctly to prevent loose joints, exhaust leaks and rattles.

Arrow A shows the expanded tube and the preinstalled exhaust clamp being brought up to the corresponding tube.

Arrow B shows the overlapping tube installed correctly over the corresponding tube.

Arrow C shows the exhaust band clamp being brought to the edge of the expanded tube.



NOTES:

- **Do not** fully torque any exhaust clamp until the entire exhaust has been installed and adjusted.
- Torque specification is a **minimum** of 60 ft/lbs

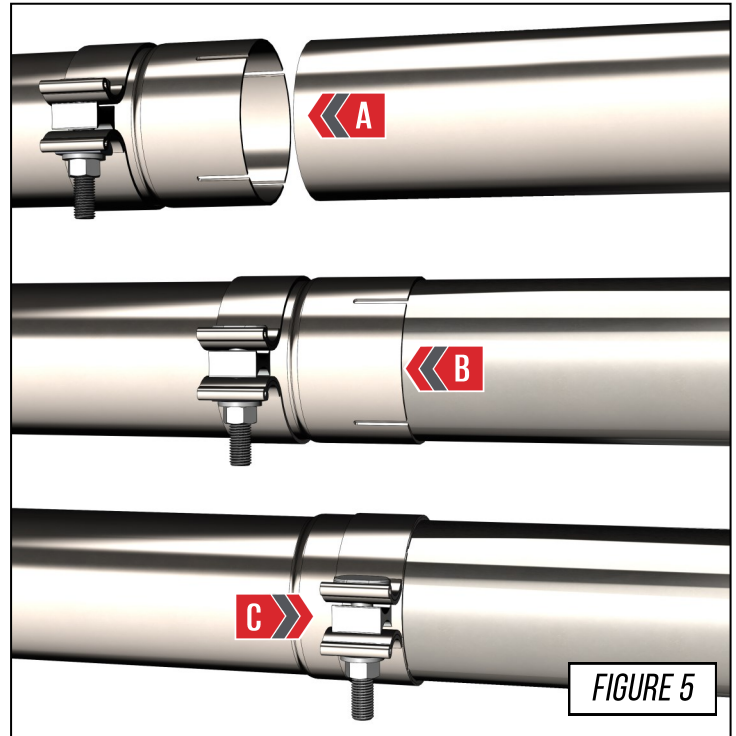

FIGURE 5

STEP 6

Gather the AWE **PS** mid pipe and **PS** rear section. The axle tube has no hangers, for ease install both tube sections, as shown in **Figure 6**, with the supplied clamp at (A) and the OEM hangers at (B).

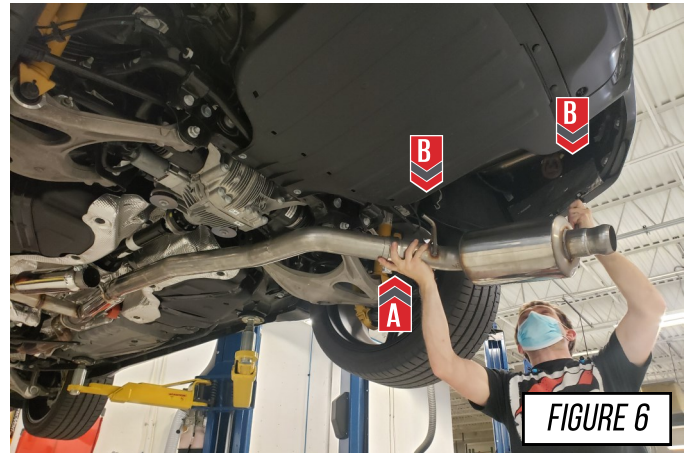

FIGURE 6

STEP 7

Gather the AWE **DS** mid pipe and **DS** rear section. The axle pipe has no hangers, for ease install both tube sections, as shown in **Figure 7**, with the supplied clamp at (A) and the OEM hangers at (B).

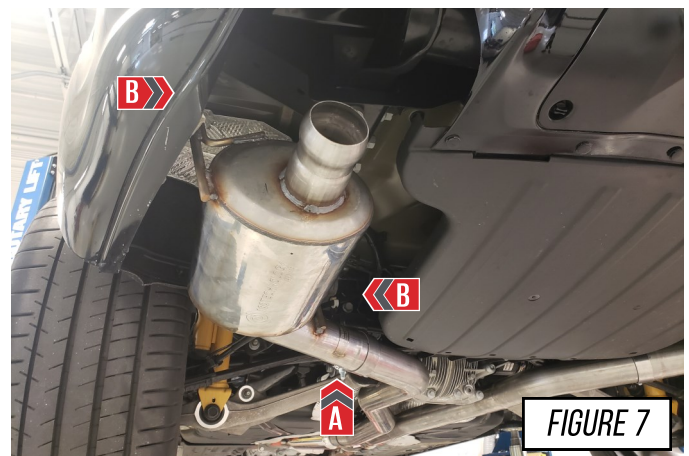

FIGURE 7

STEP 8

OE Exhaust Tips Only

Remove the driver and passenger side OEM tip (A) and ball clamp (B), as shown in **Figure 8-1**. The ball clamp has a small weld that will need to be broken, a small tear will have no effect (C), as shown in **Figure 8-2**.



STEP 9

OE Exhaust Tips Only

Install the OEM tips and clamps onto the AWE exhaust, do not fully tighten ball clamps at this point.

 Use anti-seize in the threads of the clamps.

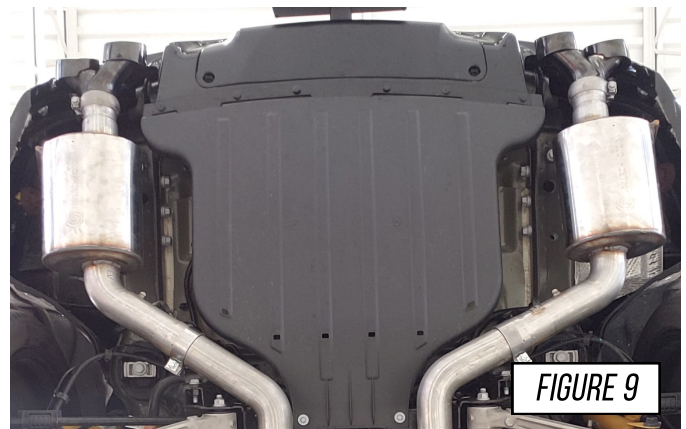

STEP 10

AWE Exhaust Tips Only

Install the AWE tips and hardware onto the AWE exhaust, do not fully tighten ball clamps at this point.

 Use anti-seize in the threads of the clamps.

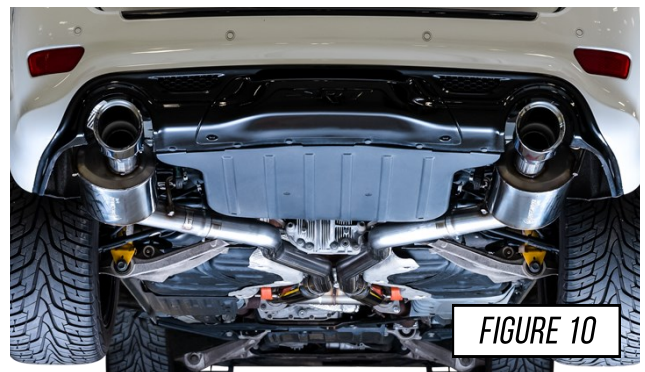

STEP 11

AWE Exhaust Tips Only

To install the exhaust tips with integrated clamps, first, attach the exhaust tip in the proper orientation onto the exhaust outlet tube.

Insert one of the carriage bolts from the hardware kit (**3910-41010**) through the tab on the exhaust tip and thread on one of the corresponding nuts.

Using anti-seize on the bolt threads will help installation and prevent breakage of hardware.

 This exhaust system only has 2 exhaust tips while the integrated clamp kit has enough hardware for our 4 tip exhaust systems. You will have 2 sets of hardware left over that will not be used.

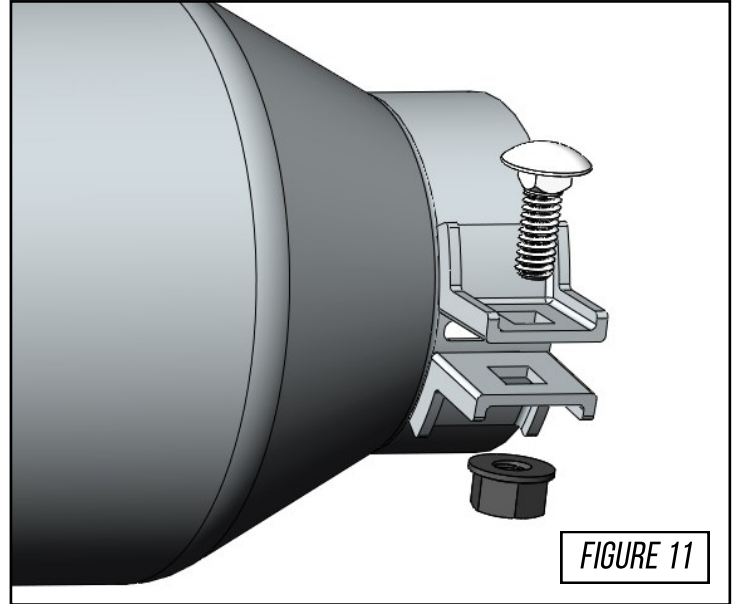

STEP 12

Check over your AWE exhaust for proper clearance from the chassis and correct tip alignment, working from the front to the back, ensure you torqued all the exhaust clamps to at least 60ft-lbs, and the tips are torqued to at least 18ft-lbs.

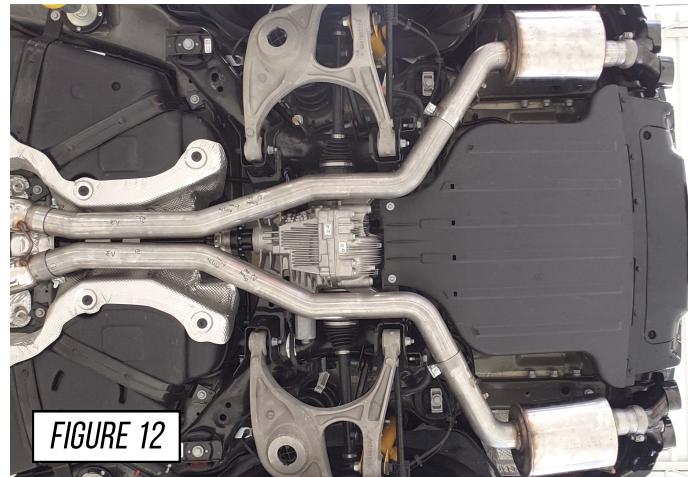

STEP 13

For the rear sections, hanger bar collar clamps are provided to prevent side to side movement of the exhaust system. After sliding the exhaust hanger bar through the OEM grommet, install the collar clamp on the outside end of the bar as shown in **Figure 13-1**, in the locations shown in **Figure 31-2**.

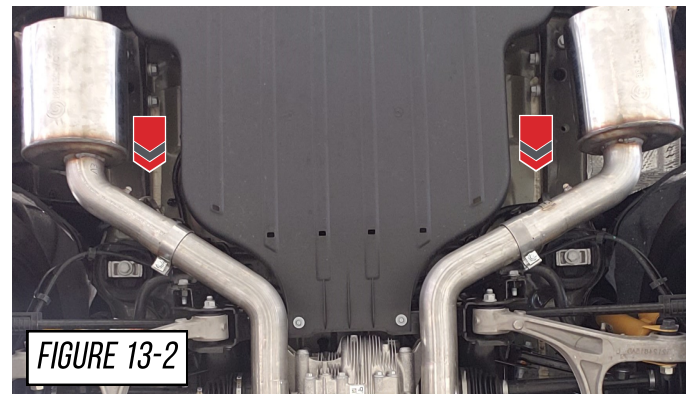
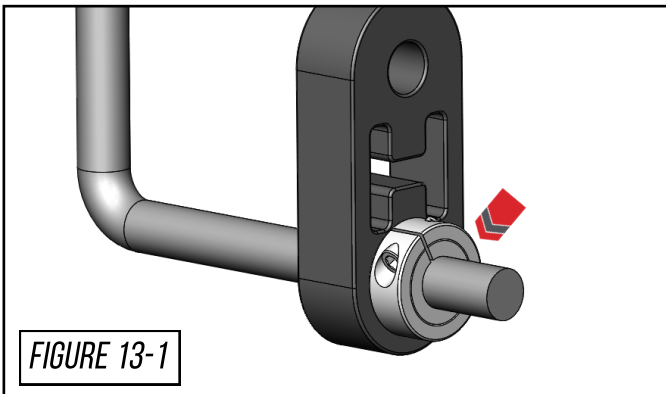

STEP 14

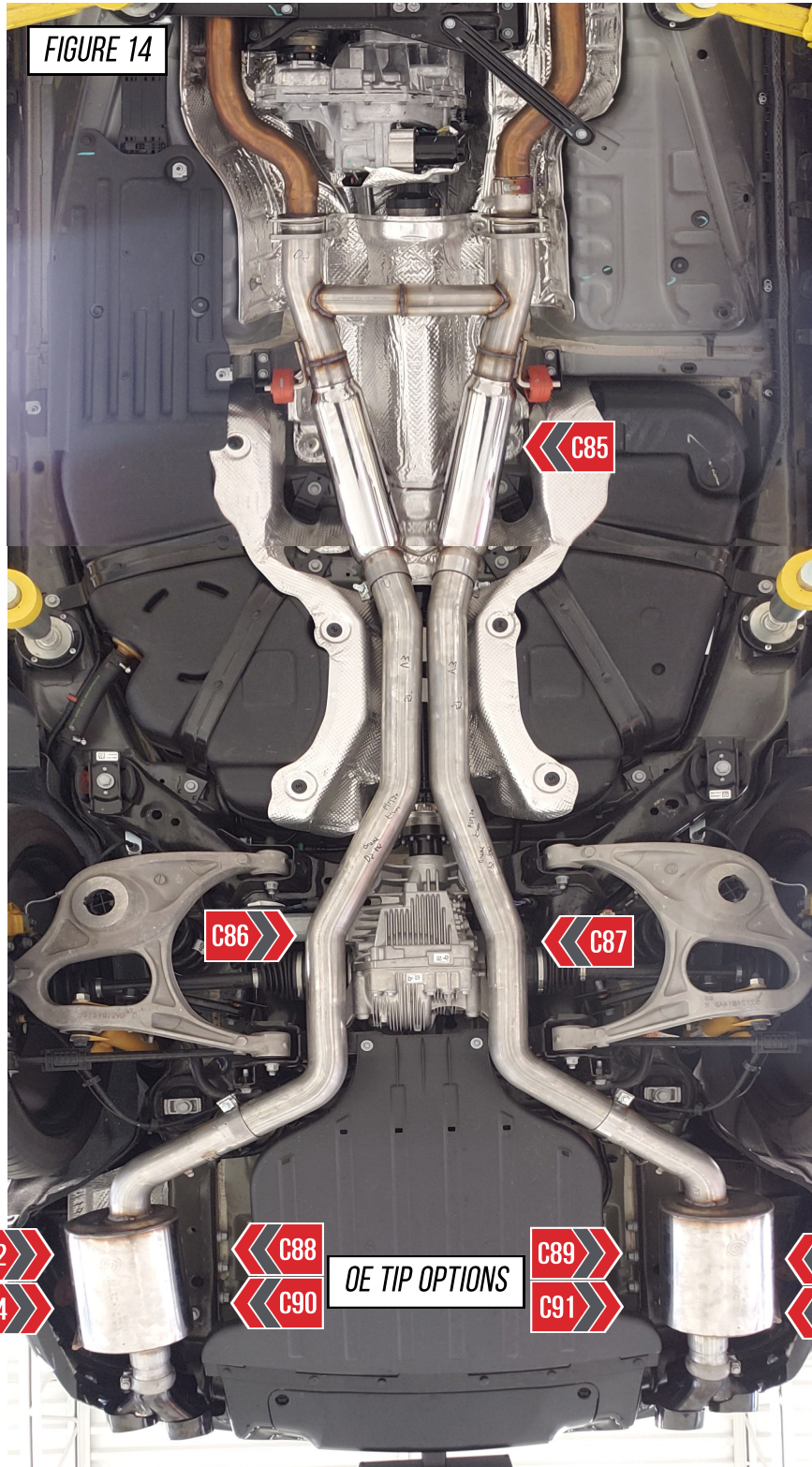

ENJOY!



TROUBLESHOOTING

Issue	Solution
Exhaust is not fitting correctly	Most fitment issues are due to improperly adjusted exhaust. This includes tip fitments and rattling due to chassis contact. Check out our fitment guide for more installation tips.
Wrong or missing parts	Double check the parts list for your system and compare them with what you received. Fill out our contact form, found below and let us know what parts you need.

CARE

Once installed properly, your AWE exhaust will provide years of trouble-free performance.

The exhaust volume and sound will settle with usage; 800-1000 miles is required to break-in new exhaust systems.

Also, please note that the rear **180Technology®** resonator has a small drain hole to allow condensation to escape. Water drops from this area are normal.

Periodic cleaning of exhaust tips is necessary to maintain proper finish, especially in areas prone to road salt and caustic deicing solutions. Use a mild soap and water solution or car wax to clean the finish. Avoid using abrasive polishes, as they can scratch the finish.

Any questions or comments,
please do not hesitate to contact us:

AWE
199 Precision Drive
Horsham, PA 19044
215-658-1670
[CONTACT FORM](#)

WARRANTY

Up-to-date warranty information is found [HERE](#).