



## **INSTALLATION GUIDE: AWE EXHAUST SUITE FOR THE JEEP WRANGLER JL 392**

For up-to-date fitment information, please visit the product page on [AWE-Tuning.com](https://www.awe-tuning.com).

### **THIS GUIDE IS INTENDED FOR THE FOLLOWING PART NUMBERS:**

3025-41392 AWE Trail Edition Switchpath Exhaust for Wrangler 392 - Quad BashGuards

Welcome to the AWE family, and congratulations on your purchase of the AWE Exhaust System for the Jeep Wrangler JL 392.

Exquisite build quality and craftsmanship, coupled with industry leading performance, distinguish this exhaust system from all others.

\*For up to the minute fitment information, be sure to visit the AWE website. As always, AWE Performance Specialists are standing by for any questions, [right here](#).

# PARTS LIST (TRAIL EDITION)



Inspect **ALL** parts prior to disassembly of vehicle; If damaged or **MISSING**, please contact the place of purchase immediately.

Symbol	Part Number	Description	QTY
	E99	JL Jeep Wrangler 6.4L/392 H Pipe	1
	F01	JL Jeep Wrangler 6.4L/392 Driver Resonator Section	1
	F02	JL Jeep Wrangler 6.4L/392 Passenger Resonator Section	1
	F03	JL Jeep Wrangler 6.4L/392 Passenger Rear Tube	1
	F04	JL Jeep Wrangler 6.4L/392 Driver Valve Section	1
	F05	JL Jeep Wrangler 6.4L/392 Passenger Resonator Section	1
	F06	JL Jeep Wrangler 6.4L/392 Muffler Assembly	1
	F07	JL Jeep Wrangler 6.4L/392 Driver Inner Tip	1
	F08	JL Jeep Wrangler 6.4L/392 Passenger Inner Tip	1
<b>A</b> >>	TFUB.012-AWE	1/8" Vacuum Hose	1
<b>B</b> >>	5058K13	Vacuum Hose Barbs	2
<b>C</b> >>	6898K46	Metal Zip Ties	4
<b>D</b> >>	7130K59	Medium Zip Ties	3
<b>E</b> >>	180275	2.75" Clamps	2
<b>F</b> >>	180300	3" Clamps	9
<b>G</b> >>	3910-11012	Lock Collar Clamp Kit	1
<b>H</b> >>	13500-6	Adhesive Backed Heat Barrier 5" x 20" Silver	1

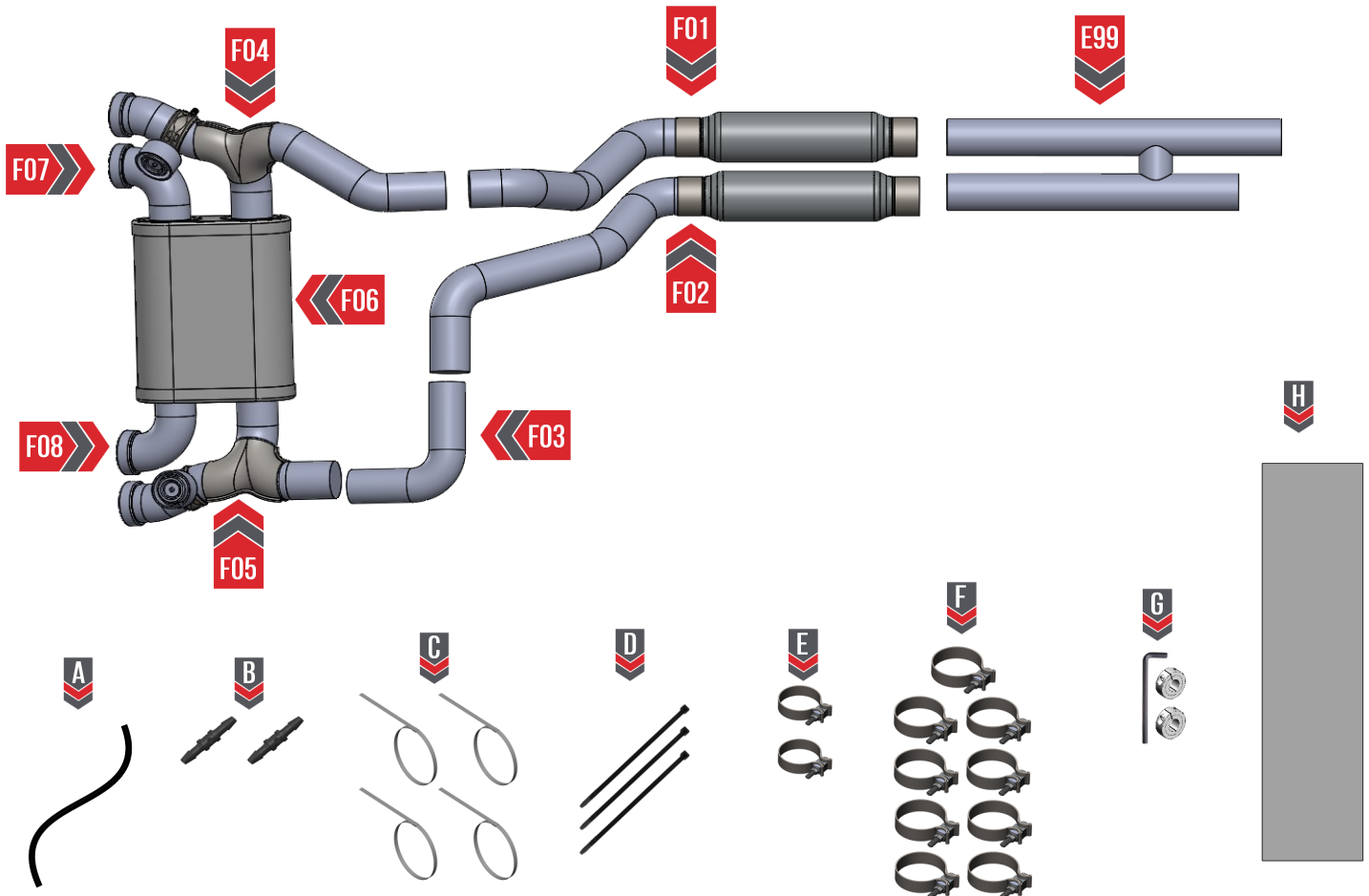



**NOTE:** Always refer to the manufacturer's service manual for precise torque specifications on all OEM fasteners.



**CAUTION:** The exhaust may be **VERY HOT** — allow adequate time for the system to cool down before disassembly. Severe burns and injury will occur if skin comes into contact with a hot exhaust system.

## STEP 1

Begin by placing a pole jack under the OE muffler section, as shown in **Figure 1**.

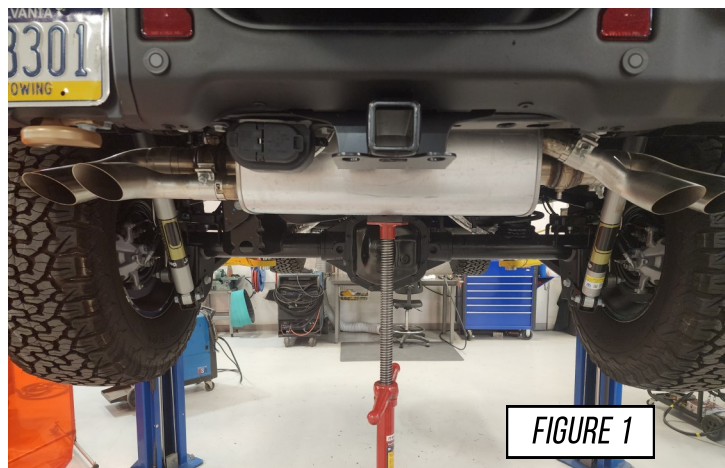

## STEP 2

Remove the 2 OE vacuum hoses from the OE valves. The driver side valve (**A**) is shown in **Figure 2-1**. The passenger side valve (**B**) is shown in **Figure 2-2**.

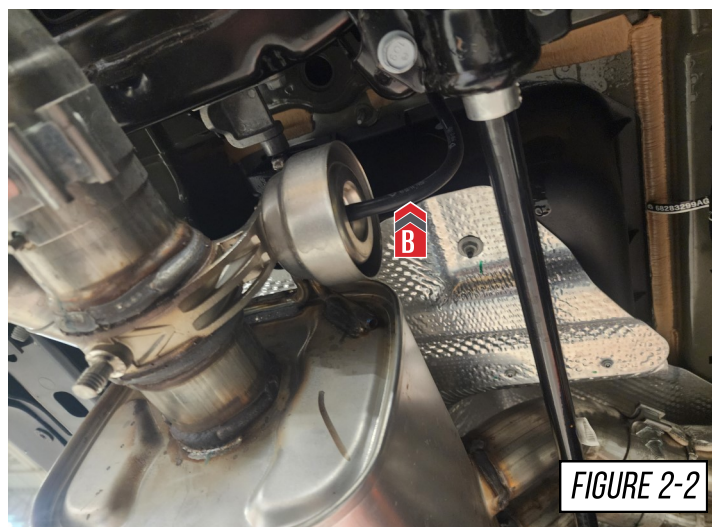
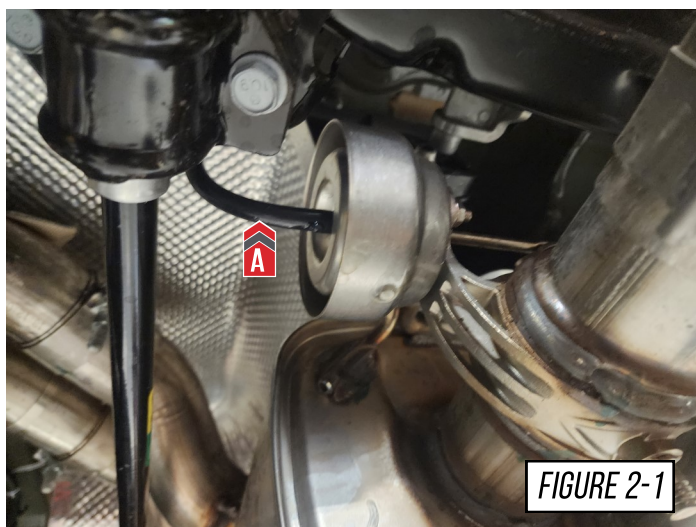

## STEP 3

Remove the bolts holding the 2 OE muffler hangers to the frame. Repeat for the opposite side.

**Note:** The OE hangers will be reused.

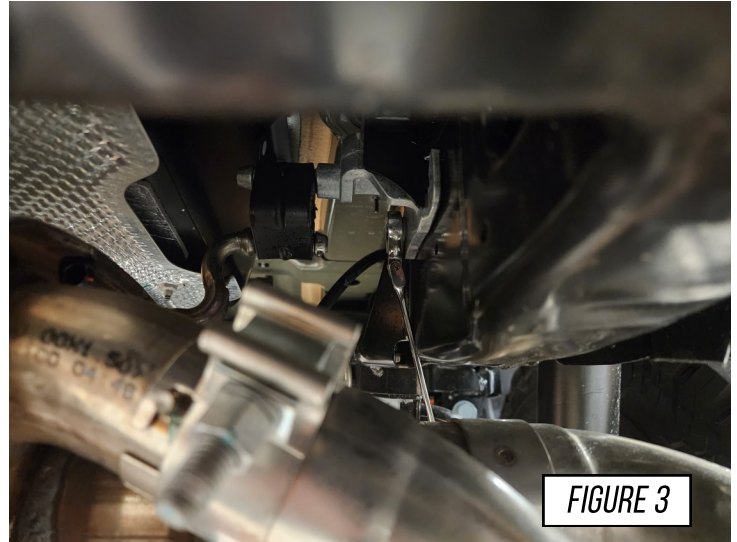

## STEP 4

Loosen the 2 OE clamps on the muffler section as shown in **Figure 4**.

With the clamps loosened you can now remove the rear OE muffler section.



## STEP 5

Disconnect the mid muffler hanger bar from the OE rubber hanger as shown in **Figure 5**.

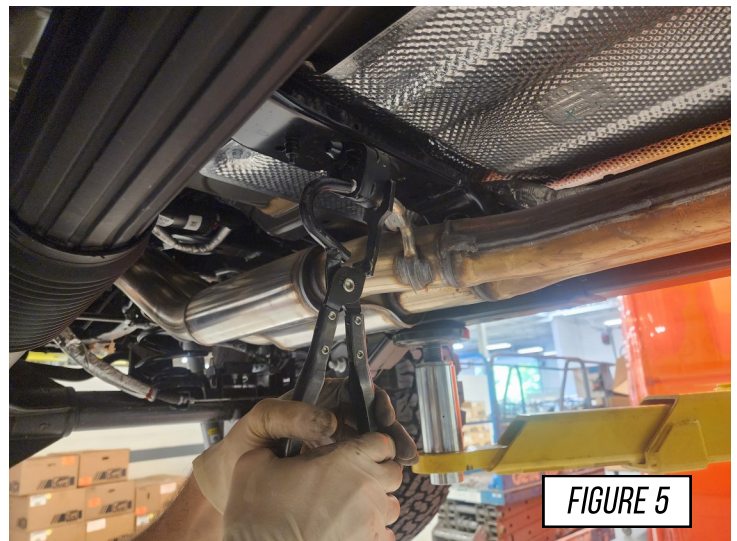

## STEP 6

Loosen the clamps (A) on the OE X-pipe as shown in **Figure 6-1**. With the clamps loosened pull the remaining OE exhaust back to remove the remainder of the OE system (B) from the car, as shown in **Figure 6-2**.

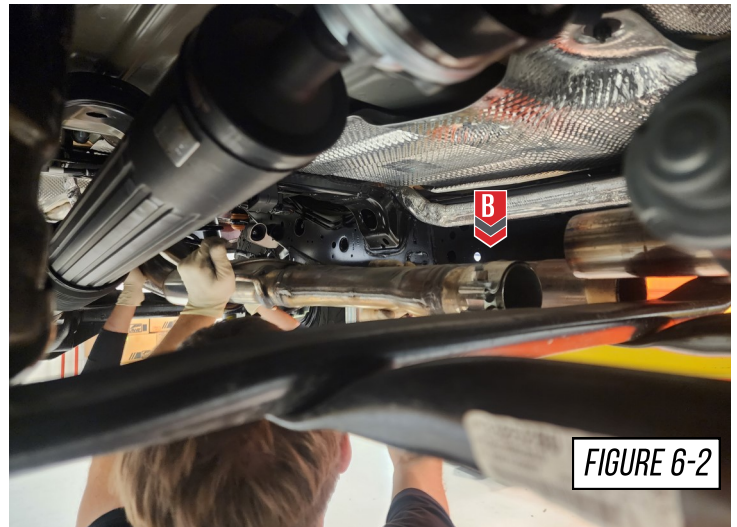
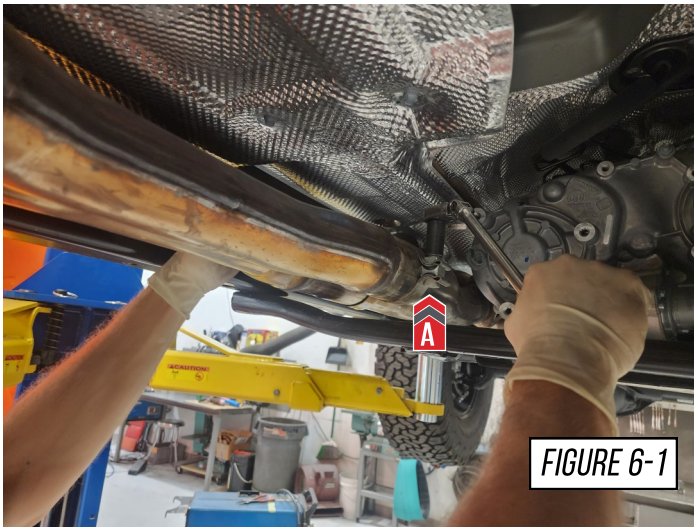

## STEP 7

Disconnect the OE differential breather hose from the barbs (A) as shown in **Figure 7-1**. Then move the breather hose towards the front of the vehicle and secure it on the barb (B), shown in **Figure 7-2**.

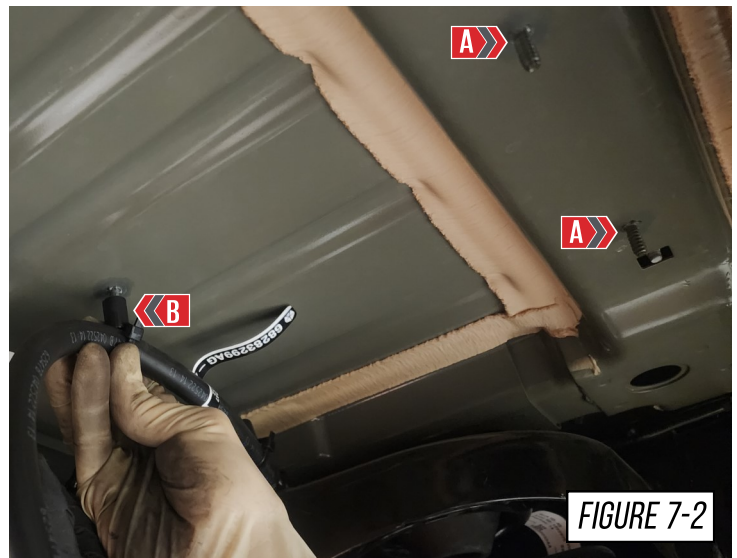
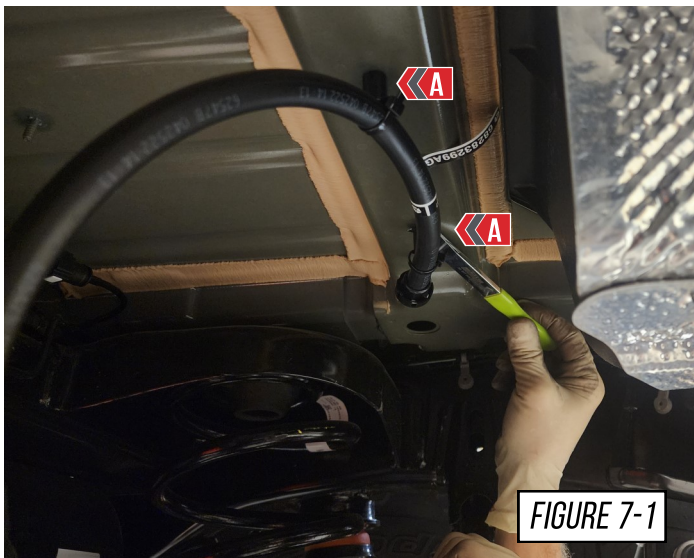

## STEP 8

Using a provided cable tie, secure the differential breather hose to the emergency brake cable, as shown in **Figure 8**.



## STEP 9

Install the provided barb (A) into the driver side OE valve hose, as shown in **Figure 9**.

Repeat for the passenger side.

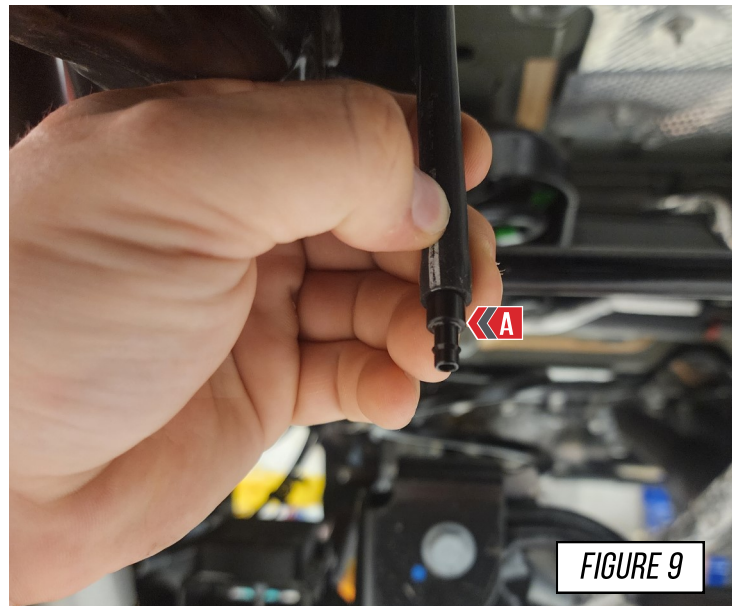

## STEP 10

Remove the nut on the OE trunk cavity heat shield as shown at (A) in **Figure 10**.

This will lower the OE heat shield to allow you to apply the provided heat shield.

**Note:** The nut will be reused.



## STEP 11

Thoroughly clean the exposed plastic section of the trunk cavity as shown in **Figure 11**.

Wipe down all of the exposed plastic to allow the heat shield adhesive to apply properly.



## STEP 12

Gather your AWE heat shield, You will need to make 3 cuts before applying it.

1. First measure  $3\frac{3}{8}$ " in from the right side and mark the measurement then measure  $11\frac{1}{4}$ " from the right side, and mark the measurement.
2. Cut the shield into two pieces at the  $3\frac{3}{8}$ " measurement. Pieces A, and B can be seen below in **Figure 12**.
3. In the middle of piece A measure in  $1\frac{7}{8}$ " and cut a slit to that length.
4. Next at the  $11\frac{1}{4}$ " measure marked on piece B measure in  $2\frac{1}{2}$ " and cut a slit to that length.



**These cuts are essential for proper installation of the heat shield.**

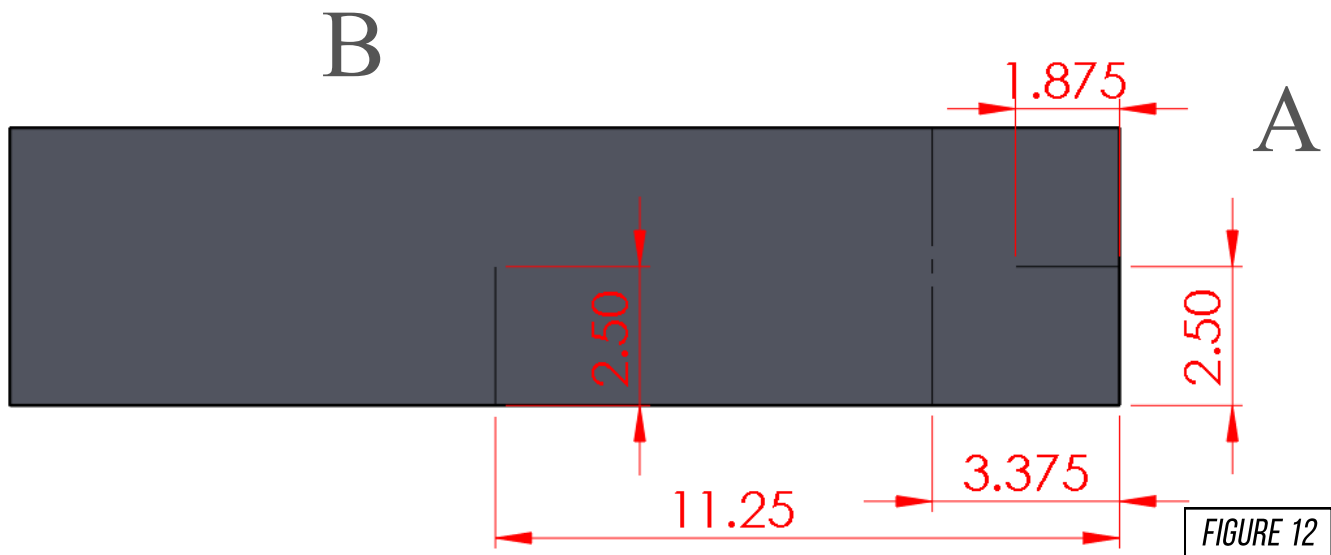



## STEP 13

Install piece A that was cut in **Step 12**, first on the front exposed corner of the trunk cavity. Line up the slit in the middle top of the corner to allow for folding. Apply, and wrap piece A from the bottom of the cavity, and move up.

Install piece B by wrapping from the back of the cavity, and move forward. Start 1 inch around the back corner, as shown at (A) in **Figure 13** then wrap towards the front of the cavity. The slit should align on the front corner.

The result should look similar to what can be seen in **Figure 13**.

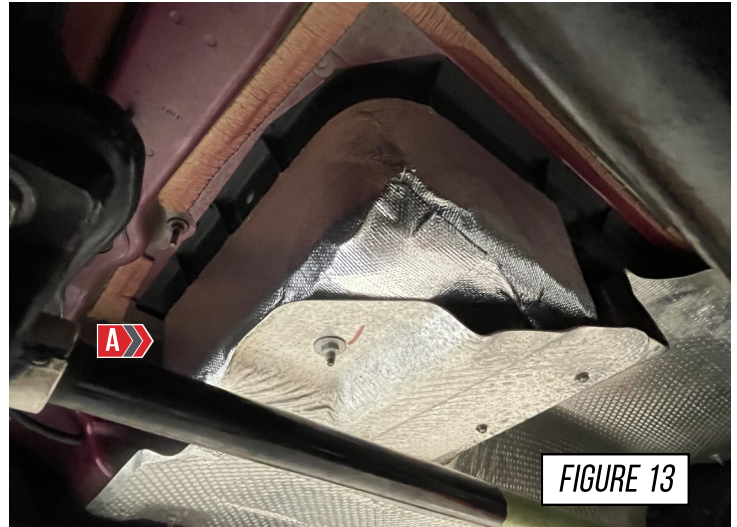

FIGURE 13



**Do not install any heat shielding on the fins at the top of the trunk cavity.**

## STEP 14

Measure, and cut your provided 1/8 inch silicone vacuum hose into two 6 inch pieces.

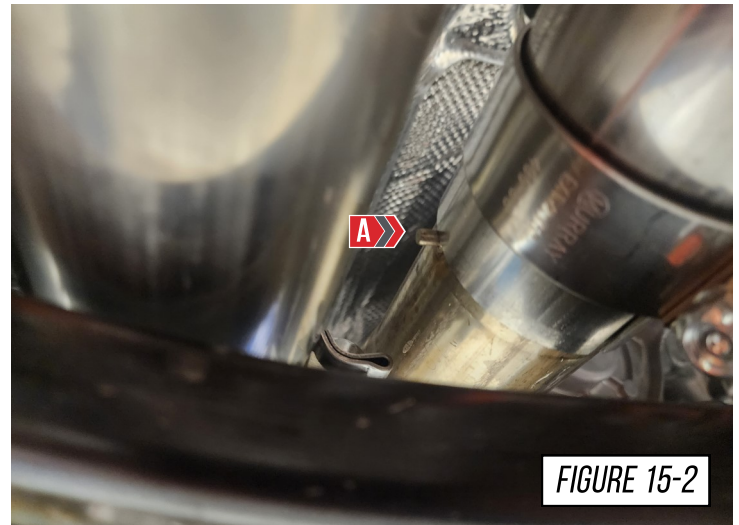

FIGURE 14

## STEP 15

Gather your AWE H-pipe, and the two provided 2.75" clamps. Slide the clamps over the expanded ends of the H-pipe. Slide the H-pipe onto the OE front pipes, as shown in **Figure 15-1**. Ensure the tube is bottomed out on the pin, as shown at **(A)** in **Figure 15-2**.

**Note:** Position the clamps so they can be easily reached and tightened.



## STEP 16

Slide the hanger bar on your AWE H-pipe into the OE rubber hanger, as shown in **Figure 16**. At this point you can fully tighten the clamps on the H-pipe.

**Note:** The h-pipe will be angled slightly and the hanger bar should be parallel with the ground, as shown at **(A)** in **Figure 16**.

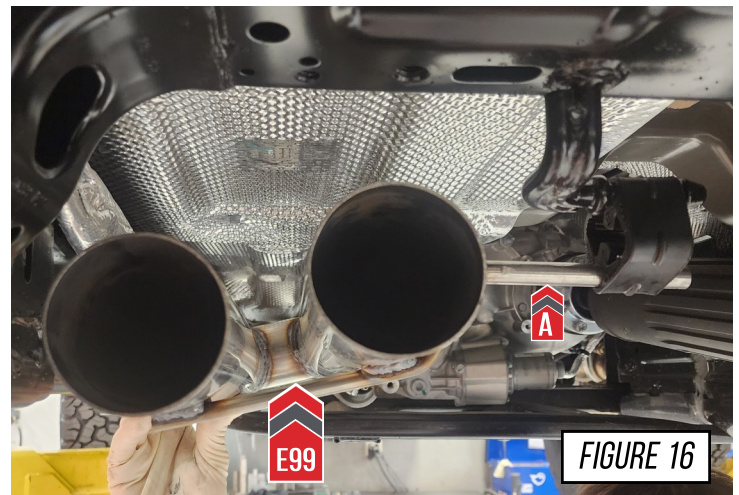

## STEP 17

It is crucial to install each section and exhaust band clamps correctly to prevent loose joints, exhaust leaks and rattles.

**Arrow A** shows the expanded pipe and the preinstalled exhaust clamp being brought up to the corresponding pipe.

**Arrow B** shows the overlapping pipe installed correctly over the corresponding pipe.

**Arrow C** shows the exhaust band clamp being brought to the edge of the expanded pipe.



### NOTES:

- **Do not** fully torque any exhaust clamp until the entire exhaust has been installed and adjusted.
- Torque specification is a **minimum** of 60 ft/lbs

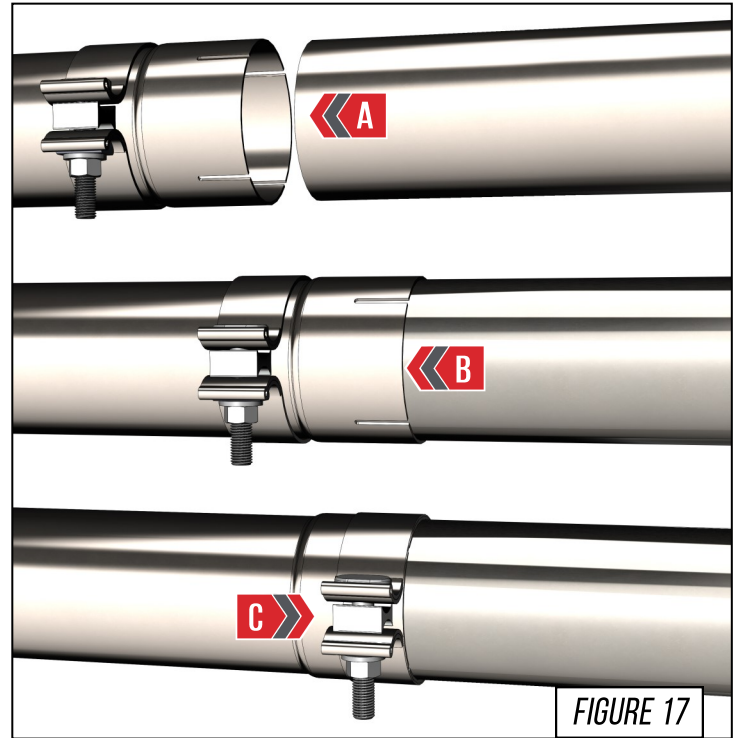

FIGURE 17

## STEP 18

Slide a provided clamp onto your AWE driver side resonator section (**F01**).

First slide the hanger bar into the OE hanger (**A**), then bottom out the slip joint on the driver side outlet of the H-pipe (**E99**), as shown at (**B**) in **Figure 18**.

Snug the clamp, but do not fully tighten it at this time.

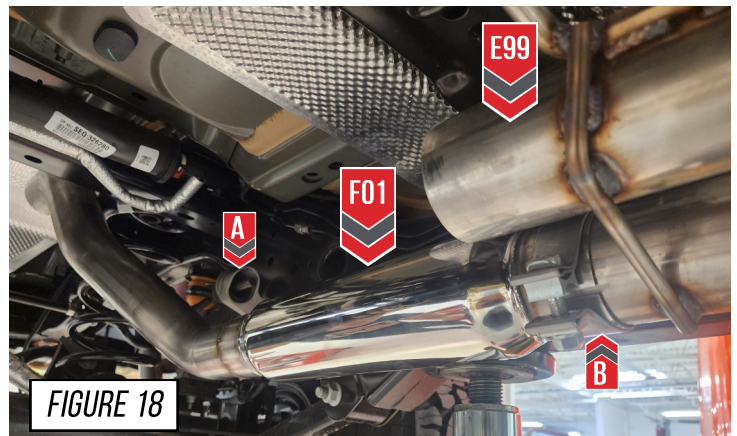

FIGURE 18

## STEP 19

Slide a provided clamp onto your AWE passenger side resonator section (**F02**).

Bottom out the slip joint on the passenger side outlet of the H-pipe (**E99**), as shown at (**A**) in **Figure 18**.

Snug the clamp, but do not fully tighten it at this time.

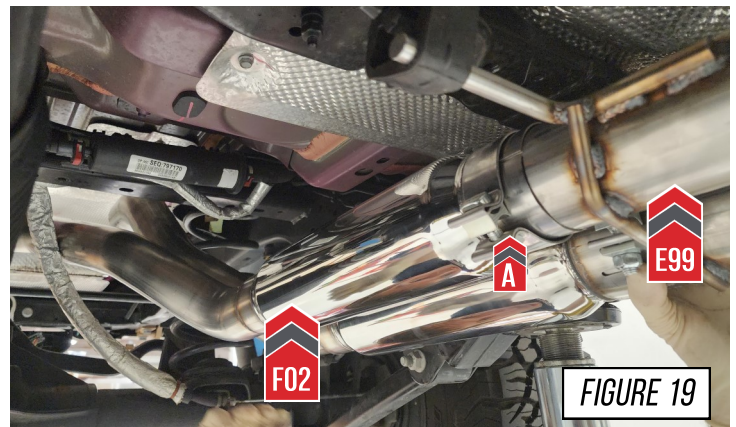

FIGURE 19

## STEP 20

Install your AWE passenger side rear tube (F03). Slide a provided clamp over the slip fit.

Bottom out the slip fit and point the outlet of the connection tube towards the rear of the car.

Snug the clamp, but do not fully tighten it at this time.

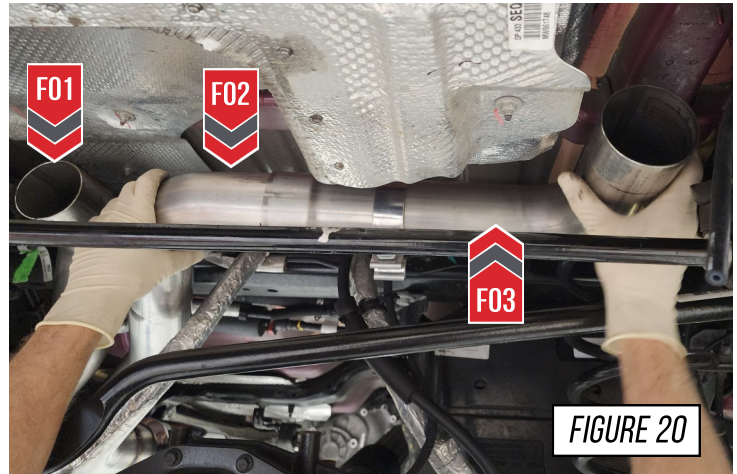

FIGURE 20

## STEP 21

Remove the OE muffler section hangers, as shown in **Figure 21-1**.

Next assemble your rear section.

First lay your AWE muffler assembly (F06) down with the flat side facing up.

Using two provided clamps secure your AWE inner tips (F07/F08) onto the rear facing side of the muffler.

**Note:** The rear side of the muffler will have the badge on the bottom.

Using two provided clamps secure your AWE driver, and passenger valve sections (F04/F05) to front facing side of the muffler.

Secure the OE rubber hangers to the hanger bars on the assembly, as shown at (A) in **Figure 21-2**.

Secure the 6" pieces of silicone hose that were cut in **Step 14** to the valves, shown at (B) in **Figure 21-2**.

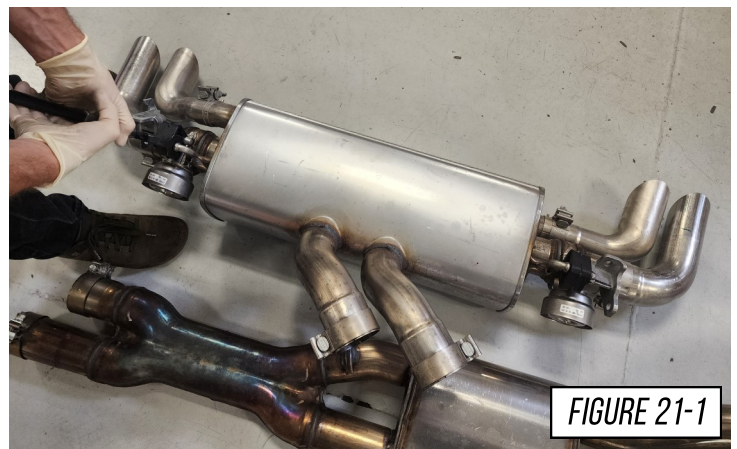

FIGURE 21-1

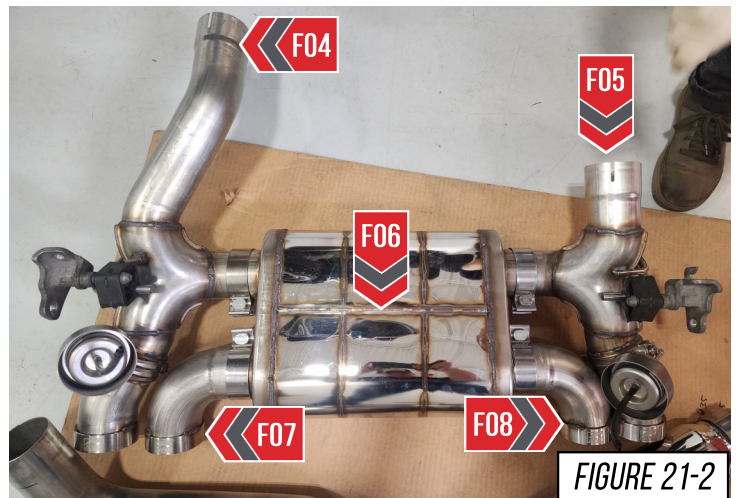
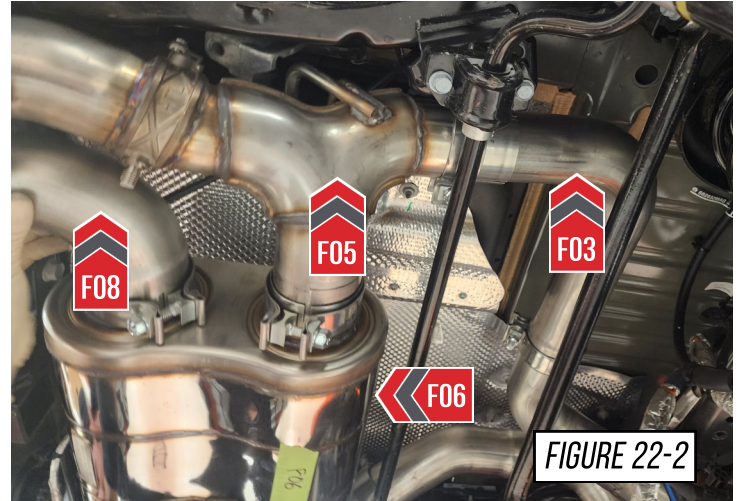
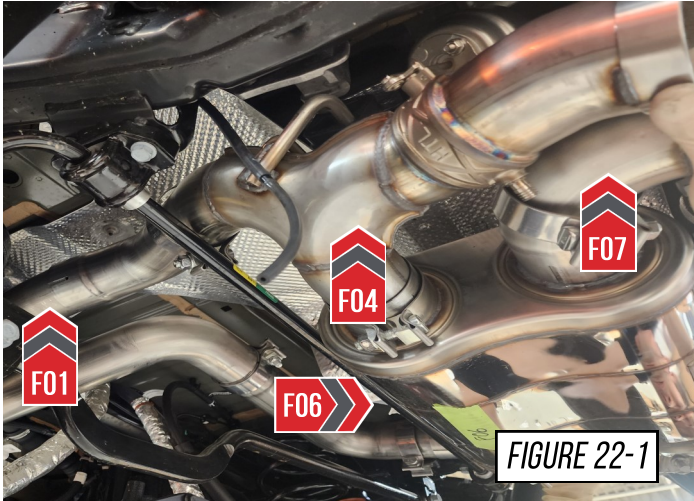

FIGURE 21-2

## STEP 22

Slide a provided clamp over each valve section inlet. Then install your entire AWE rear muffler assembly. Lift the entire assembly into the cavity, and bottom out the valve sections (**F04/F05**) slip fits on to the driver side resonator section (**F01**), as shown in **Figure 22-1** and the passenger side rear tube (**F03**), as shown in **Figure 22-2**.



## STEP 23

Reinstall the driver side OE hangers, shown at (A) in **Figure 23** using the OE hardware.

Repeat for passenger side.

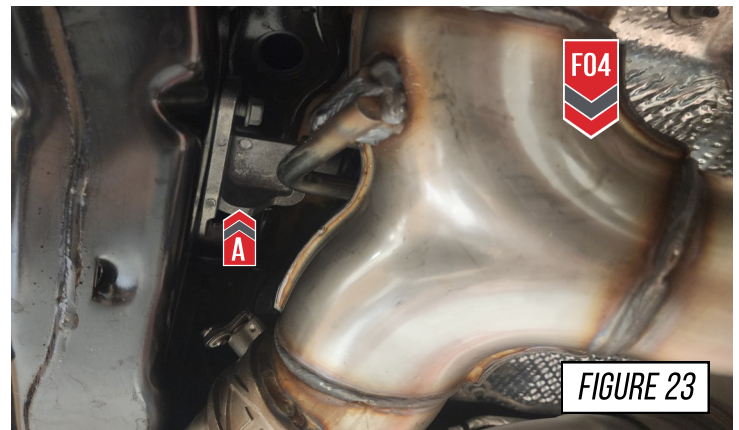

## STEP 24

Position the muffler assembly with the muffler rotated down, and away from the cavity, as shown in **Figure 24**. This will allow enough space to use your hands in the following steps.

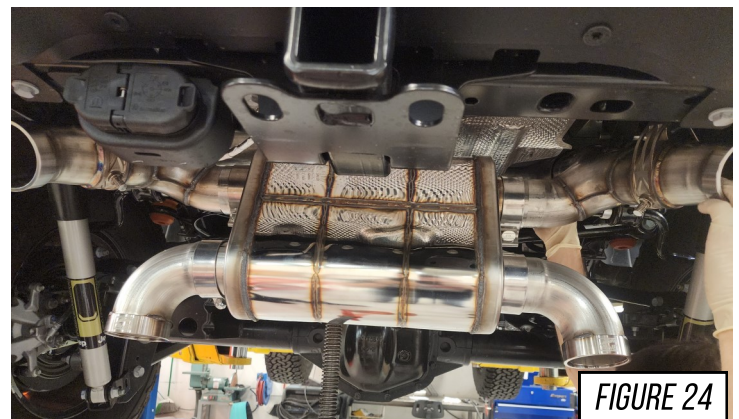

## STEP 25

Connect the hose on that was put on the valve section in **Step 21** to the barbs that were installed in **Step 9**, as shown in **Figure 25-1**. Using a provided cable tie, secure the silicone valve hose (**A**) to the OE mount, as shown in **Figure 25-2**. Repeat for the opposite side.

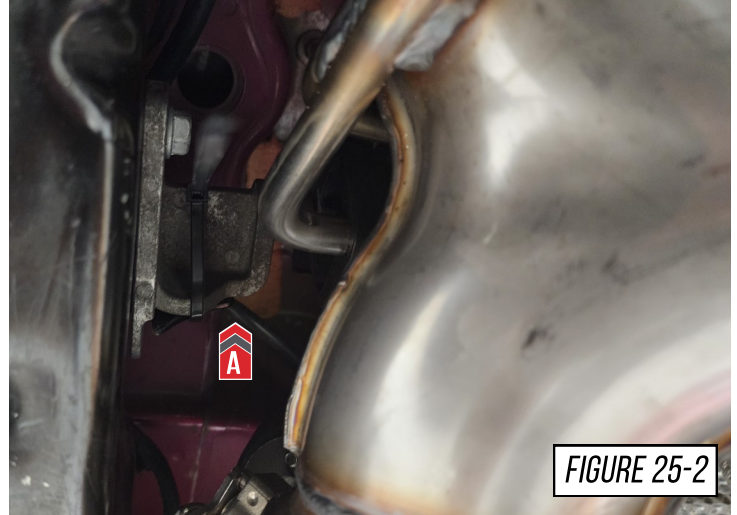
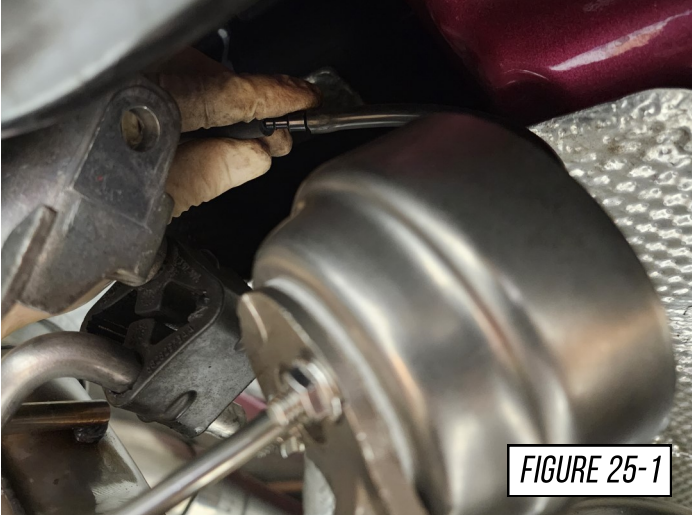

## STEP 26

Position your exhaust outlets in a location that you are satisfied with, then tighten down the clamps.

**Note:** It can be helpful to use a long level to evenly align all four outlets.



## STEP 27

Secure the lock collar clamp (**A**) on the muffler assembly hanger bars. Make sure they are in full contact with the OE rubber hanger, as shown in **Figure 27**.

Repeat for the opposite side.

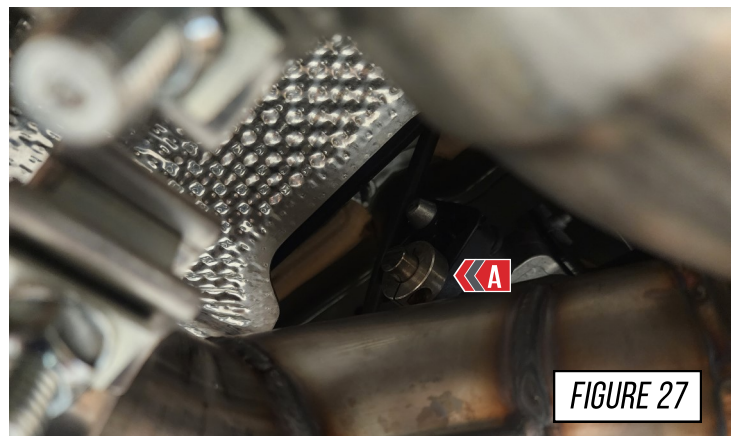

## STEP 28

Remove the OE heat shield from the OE over axle tubes, as shown in **Figure 28**.

**Note:** The OE heat shield bands will not be reused.



FIGURE 28

## STEP 29

Install the OE heat shield on your AWE resonator tubes (**F01/F02**), and your AWE driver side valve section (**F04**).

Position the heat shield just below the bends on the top of the tubes.

Loosely secure the provided metal cable ties (**A**), as shown in **Figure 29**.

Once you are satisfied with the positioning of the OE heat shield fully tighten down the metal cable ties.

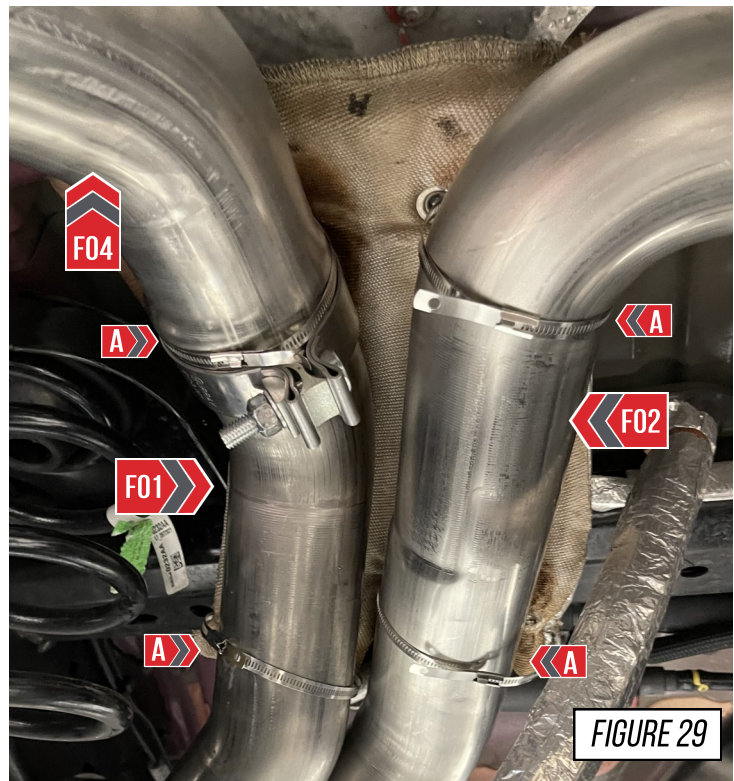

FIGURE 29

## STEP 30

Make your final adjustments to the outlets to ensure they are in a position you like. Once the desired positioning is achieved, fully tighten down all clamps.

It is now recommended to drive the car to allow the exhaust to heat cycle after all clamps and tips are fully tightened.



At this point the exhaust will be **very hot**, allow to cool before work continues.

Check the outlets for correct alignment, adjust as needed.



Don't forget to see the next page for any troubleshooting needs!



# ENJOY!





# TROUBLESHOOTING

Issue	Solution
Exhaust is not fitting correctly	Most fitment issues are due to improperly adjusted exhaust. This includes tip fitments and rattling due to chassis contact. Check out our <a href="#">fitment guide</a> for more installation tips.
Incorrect or missing parts	Double check the parts list for your system and compare them with what you received. Fill out our contact form, found below and let us know what parts you need.

# CARE

Once installed properly, your AWE exhaust will provide years of trouble-free performance.

The exhaust volume and sound will settle with usage; 800-1000 miles is required to break-in new exhaust systems.

Also, please note that the rear **180Technology**® resonator has a small drain hole to allow condensation to escape. Water drops from this area are normal.

Periodic cleaning of exhaust tips is necessary to maintain proper finish, especially in areas prone to road salt and caustic deicing solutions. Use a mild soap and water solution or car wax to clean the finish. Avoid using abrasive polishes, as they can scratch the finish.

Any questions or comments,  
please do not hesitate to contact us:

**AWE**  
**CONTACT FORM**

# WARRANTY

Up-to-date warranty information is found [HERE](#).