





INSTALLATION INSTRUCTIONS

Shorty Headers

MAKE: RAM
 MODEL: 1500 TRX
 YEAR: 2021-2023
 ENGINE: V8 6.2L (sc)

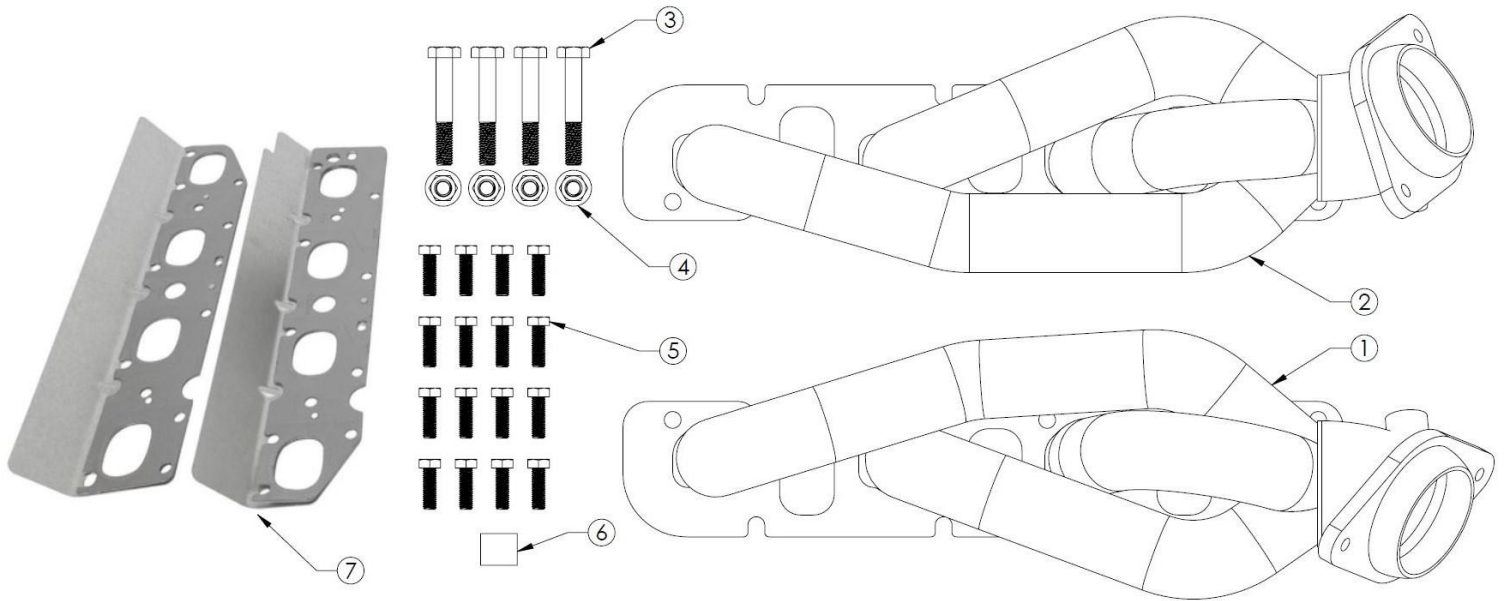
49-32030
 49-32030-T





EMISSIONS DISCLAIMER
 This product is not currently CARB exempt and is not available for purchase in California or for use on any vehicle registered with the California Department of Motor Vehicles.

Item	Description	Part Number	Quantity
1	Left Header	05-245199	1
1	Left Header (Titanium Ceramic Coat)	05-245199T	1
2	Right Header	05-245200	1
2	Right Header (Titanium Ceramic Coat)	05-245200T	1
3	Bolt, M10 x 1.5 x 65mm	03-50346	4
4	Nut, M10 x 1.5	03-50189	4
5	Bolt, M8 x 1.25 x 25mm	03-50421	16
6	Spacer, 3/4"OD x 5/16"ID x 5/8"L	05-46094	1
7	Gasket Set	05-46093	1

aFe POWER recommends professional installation on this product. Thoroughly inspect the aFe POWER exhaust system to make sure there is no damage from shipping (if damage is noted, immediately contact aFe POWER customer service). Allow time for your vehicle to cool down prior to installation. When working on your vehicle proceed with caution. Wear protective safety equipment; eye goggles and gloves to ensure a safe installation.

Install band clamps to proper torque specifications of 40-45 ft-lb.

Install V-band clamps with anti-seize lubricant and hand tighten only to torque specifications of 10-15 ft-lb.



INSTALLATION INSTRUCTIONS

Shorty Headers

MAKE: RAM
MODEL: 1500 TRX
YEAR: 2021-2022
ENGINE: V8 6.2L (sc)

49-32030
49-32030-T

1. **(Read instructions prior to installation.)** It is recommended to not fully tighten the exhaust until it has been fully installed. Leave loose for adjustability.
2. Secure vehicle on jack stands (refer to your manual for specified jack stand positions).
3. For faster installation, spread out the parts of the exhaust alongside your vehicle as shown in the diagram above.
4. Secure the stock exhaust with jack/stands.
5. Disconnect and the negative battery cable.
6. Remove the engine cover.
7. Remove bolt and nut securing the dipstick tube and remove from vehicle.
8. Remove the transmission skid plate and the transfer case skid plate.
9. Remove the left and right catalytic converters.
10. Remove the fasteners and the left and right lower splash shield.
11. Remove the left and right wheelhouse splash shield.
12. Remove the left exhaust manifold heat shield.
13. Starting from the center top manifold bolt, remove the bolts in a clockwise pattern securing the exhaust manifold to the cylinder head. Retain the upper left bolt that the dipstick tube is secured with, it will be re-used.
14. Remove the left exhaust manifold and discard the gasket.
15. Remove the right exhaust manifold heat shield.
16. Starting from the center top manifold bolt, remove the bolts in a clockwise pattern securing the exhaust manifold to the cylinder head.
17. Remove and right exhaust manifold and discard the gasket.
18. Transfer the O2 sensors from the OE manifolds to the aFe POWER shorty headers.
19. Clean the gasket mating surfaces.
20. Using the provided gasket, install the shorty headers to the cylinder head with the hardware provided and tighten the bolts finger tight.
21. The upper left bolt on the left side header will
22. Tighten the exhaust manifold retaining bolts to 18ft.-lbs. starting from the center and working your way outwards in a clockwise pattern.
23. Install the left and right wheelhouse splash shield.
24. Install the left and right lower splash shield and the fasteners.
25. Install the left and right catalytic converters using the provided hardware at the header side.
26. Install the transfer case skid plate.
27. Install the transmission skid plate.
28. Install the oil dipstick tube using the provided spacer.
29. Install the engine cover.
30. Connect the negative battery cable
31. Ensure that all the components of the aFe POWER exhaust system are aligned and are at a safe clearance from all wires, hoses, brake lines, body parts, and tires.
32. Start from the front of the aFe exhaust system and evenly tighten all clamps and fasteners.
33. Start the vehicle and check for any leaks. If any leaks are found, determine cause and repair as necessary.
34. Remove vehicle from jacks stands.
35. It is recommended to re-tighten all clamps and hardware after 50-100 miles.