



INSTALLATION INSTRUCTIONS

DPF-Back Exhaust

MAKE: Jeep
MODEL: Wrangler JL
YEAR: 2020-2022
ENGINE: V6-3.0L (td)

49-38092-P
49-38092-B

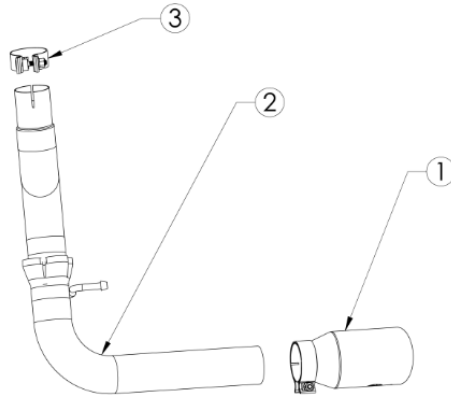

Item	Description	Part Number	Quantity
1	EXH tip 3 In x 4-1/2 Out x 9L Bolt-On Pol	49T30454-P093	1
1	EXH Tip 3 In x 4-1/2 Out x 9L Bolt-On Blk	49T30454-B093	1
2	Single Side Exit Assembly	05-145970	1
3	Clamp, Band 2-3/4" SS	05-41160	1

aFe POWER recommends professional installation on this product. Thoroughly inspect the aFe POWER exhaust system to make sure there is no damage from shipping (if damage is noted, immediately contact aFe POWER customer service). Allow time for your vehicle to cool down prior to installation. When working on your vehicle proceed with caution. Wear protective safety equipment; eye goggles and gloves to ensure a safe installation.

Install band clamps to proper torque specifications of 40-45 ft-lb.





INSTALLATION INSTRUCTIONS

MAKE: Jeep
MODEL: Wrangler JL
YEAR: 2020-2022
ENGINE: V6-3.0L (td)

DPF-Back Exhaust

49-38092-P

49-38092-B

1. **(Read instructions prior to installation.)** It is recommended to not fully tighten the exhaust until it has been fully installed. Leave loose for adjustability.
2. Secure vehicle on jack stands (refer to your manual for specified jack stand positions).
3. For faster installation, spread out the parts of the exhaust alongside your vehicle as shown in the diagram above.
4. Secure the stock exhaust with jack/stands.
5. Remove the O.E. DPF back by loosening the clamp at the top and removing the hangers from the O.E isolation mounts.
6. Install the aFe POWER Single Exit DPF back using the provided 2-3/4" Clamp and slide the hanger into the O.E. isolation mount.
7. Install the exhaust tip using the provided 3" clamp.
8. Adjust the tip to desired position and tighten.
9. Ensure that all the components of the aFe POWER exhaust system are aligned and are at a safe clearance from all wires, hoses, brake lines, body parts, and tires.
10. Start from the front of the aFe exhaust system and evenly tighten all clamps and fasteners.
11. Start the vehicle and check for any leaks. If any leaks are found, determine cause and repair as necessary.
12. Remove vehicle from jacks stands.
13. It is recommended to re-tighten all clamps and hardware after 50-100 miles.