

Dodge Challenger 5.7L Supercharger System Installation Instructions

2015-2017 Model Year

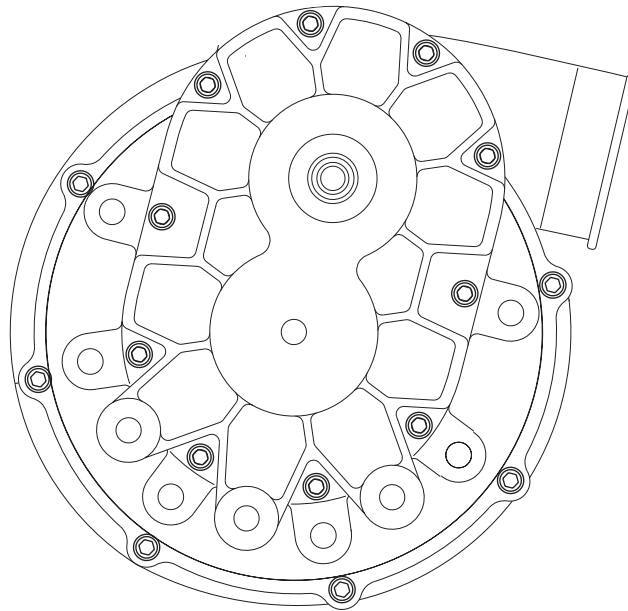

ENGINEERING, INC

1650 Pacific Avenue, Channel Islands, CA 93033-9901 • Phone (805) 247-0226
Fax: (805) 247-0669 • www.vortechsuperchargers.com • M-F 7:00 AM - 3:30 PM (PST)

FOREWORD

This manual provides information on the installation, maintenance and service of the Vortech supercharger kit expressly designed for this vehicle. All information, illustrations and specifications contained herein are based on the latest product information available at the time of this publication. Changes to the manual may be made at any time without notice. Contact Vortech Engineering for any additional information regarding this kit and any of these modifications at (805) 247-0226 7:00am-3:30pm PST.



Take note of the following before proceeding:

1. Proper installation of this supercharger kit requires general automotive mechanic knowledge and experience. Please browse through each step of this instruction manual prior to beginning the installation to determine if you should refer the job to a professional installer/technician. Please contact your dealer or Vortech Engineering for possible installers in your area.
2. This product was designed for use on stock (un-modified, OEM) vehicles. The PCM (computer), engine, transmission, drive axle ratios and tire O.D. must be stock. If the vehicle or engine has been modified in any way, check with Vortech prior to installation and use of this product.
3. Use only premium grade fuel with a minimum of 91 octane (*R+M/2*).
4. Always listen for any sign of detonation (*knocking/pinging*) and discontinue hard use (*no boost*) until problem is resolved.
5. Vortech is not responsible for any clutch, transmission, drive-line or engine damage.

Exclusions from Vortech warranty coverage considerations include, but not limited to:

1. Neglect, abuse, lack of maintenance, abnormal operation or improper installation.
2. Continued operation with an impaired vehicle or sub-system.
3. The combined use of Vortech components with other modifications such as, but not limited to, exhaust headers, aftermarket camshafts, nitrous oxide, third party PCM programming or other such changes.

©2019 VORTECH ENGINEERING, INC

All rights reserved. No part of this publication may be reproduced, transmitted, transcribed, or translated into another language in any form, by any means without written permission of Vortech Engineering, Inc.

TABLE OF CONTENTS

FOREWORD	<i>ii</i>
TABLE OF CONTENTS	<i>iii</i>
IMPORTANT NOTES	<i>iv</i>
TOOL & SUPPLY REQUIREMENTS	<i>v</i>
PARTS LIST	<i>vi</i>
1. ECU REMOVAL	1
2. BASIC COMPONENT REMOVAL	5
3. HARMONIC DAMPER DOWEL PIN INSTALLATION	13
4. LOWER RADIATOR MOUNT MODIFICATION	17
5. S/C MOUNTING BRACKET ASSEMBLY INSTALLATION	21
6. A/W COOLER, HEAT EXCHANGER & DISCHARGE TUBE INSTALLATION	25
7. AIR INLET ASSEMBLY, BYPASS VALVE SIGNAL HOSE & S/C INSTALLATION	35
8. A/W COOLING SYSTEM INSTALLATION	39
9. RADIATOR FAN SHROUD MODIFICATION & INSTALLATION	49
10. MISC. REASSEMBLY	51
11. FINAL CHECK	53
APPENDIX A - DIAGRAM, ASSEMBLY, SUPERCHARGER MOUNTING BRACKET	54
APPENDIX B - DIAGRAM, BELT ROUTING	55

NOTICE

This product is protected by state common law, copyright and/or patent. All legal rights therein are reserved. The design, layout, dimensions, geometry, and engineering features shown in this product are the exclusive property of Vortech Engineering, Inc. This product may not be copied or duplicated in whole or part, abstractly or fundamentally, intentionally or fortuitously, nor shall any design, dimension, or other information be incorporated into any product or apparatus without prior written consent of Vortech Engineering, Inc.

2015-2017 Dodge Challenger 5.7L Installation Instructions

Congratulations on selecting the best performing and best backed automotive supercharger available today... the VORTECH® supercharger!

Before beginning this installation, please read through this entire instruction booklet and the Street Supercharger System Owner's Manual which includes the Limited Warranty Program, the Warranty Registration form and return envelope.

Vortech supercharger systems are performance improving devices. In most cases, increases in torque of 30-35% and horsepower between 35-45% can be expected with the boost levels specified by Vortech Engineering. This product is intended for use on healthy, well maintained engines. Installation on a worn-out or damaged engine is not recommended and may result in failure of the engine as well as the supercharger. Vortech Engineering is not responsible for engine damage.

Installation on new vehicles will not harm or adversely affect the break-in period so long as factory break-in procedures are followed.

For best performance and continued durability, please take note of the following key points:

1. Use only premium grade fuel 91 octane or higher (R+M/2).
2. The engine must have stock compression ratio.
3. If the engine has been modified in any way, check with Vortech prior to using this product.
4. Always listen for any sign of detonation (pinging) and discontinue hard use (no boost) until problem is resolved.
5. **Oil Fed Units** - Perform an oil and filter change upon completion of this installation and prior to test driving your vehicle. Thereafter, always use a high grade SF rated engine oil or a high quality synthetic, and change the oil and filter at least every 3,000 miles. Never attempt to extend the oil change interval beyond 3,000 miles, regardless of oil manufacturer's claims as potential damage to the supercharger may result.
6. Before beginning installation, replace all spark plugs that are older than 1-year or 15,000 miles with original heat range plugs as specified by the manufacturer and reset timing to factory specifications (follow the procedures indicated within the factory repair manual and/or as indicated on the factory underhood emissions tag). Do not use platinum spark plugs unless they are original equipment. Change spark plugs every 15,000 miles.

TOOL & SUPPLY REQUIREMENTS

- 1/4" drive & 3/8" drive ratchet and drive set: SAE & metric
- 1/4" drive & 3/8" drive ratchet extensions
- Open end wrenches: SAE & metric
- Torque wrench
- Screwdriver set
- Hose cutters
- Drill motor & 1/4" drill bit
- Wire strippers & crimpers
- Utility knife
- Blue and red threadlocker

If it has been 15,000 miles or more since your vehicle's last spark plug change, then you will also need:

- Spark plug socket
- NEW spark plugs

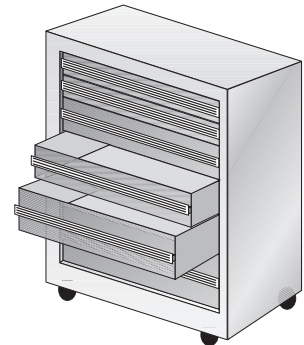



2015-2017 Dodge Challenger 5.7L

Tuner Kit Part No. 4CM218-120L

PARTS LIST

IMPORTANT: Before beginning installation, verify that all parts are included in the kit. Report any shortages or damaged parts immediately.

PART NO.	DESCRIPTION	QTY.	PART NUMBER	DESCRIPTION	QTY.
008110	SMALL SILVER DIE CUT DECAL	2	7U038-000	3/4" HEATER HOSE	1.5FT
008130	LICENSE PLATE FRAME, VORTECH 1		7U038-000	3/4" HEATER HOSE	4FT
008447	1 YR S/C STRT INFO PKG ASY VORT1		7U038-012	HOSE, 3/4 DIA 90 , 4" X 12" LEGS	1
009035	S/C LUBE, BOTTLED, 3-PACK	1	7U038-150	HOSE, 3/4 D X 150 MOLDED HOSE	2
2A046-988	BELT, K060988, GATES	1	7U041-000	1/2" HEATER HOSE	2.5FT
2F329-170	V3 S/C ASY, 6.4L HEMI CHALL	1	7U100-027	RIVET, PLASTIC, HEMI BMPR CVR	6
4CL110-110	ASY, DAMPER PIN, HEMI	1	7U100-055	TIE WRAP, 7.5" NYLON	10
4GR010-110	GUIDE, DWL PIN IST, C5	1	7U100-102	BUMPER, RUBBER, 1/4" HOLE, 1/8"	3
7C014-095	M14-1.5 X 95 MM SHCS, PLATED	1	7U133-500	1/2 X 90 MOLDED RUBBER HOSE	1
7U250-019	DOWEL PIN, 1/4D X 1/2L	1	4CM212-020	DISCH ASY, 15-17 CHALL 5.7L	1
7U250-026	DRILL BUSHING, 1/4ID, .375OD	1	4CM012-010	DISCH TUBE A, 15-17 HEMI	1
4CM020-020	INSTR MAN, 15-17 CHALL 5.7L	1	4CM012-030	DISCH SLEEVE C, 15-17 HEMI	1
4CM110-044	MNTG BRKT ASY, '16 CHALL	1	4CM012-060	DISCH SLEEVE E, 15-17 HEMI 5.7L	1
2A017-016	PILOT, 6203/5 BRG, M10 3/8 SCREW	1	4CM112-020	ASY, DISCH TUBE B, 15-17 HEMI	1
2A040-021	RETAINER, PULLEY, FLATHD	1	4CM112-040	ASY, DISCH TUBE D, 15-17 HEMI	1
2A040-051	PLY RETAINER, TAMPER PRF CAP	1	7A250-074	1/4-20 X .75 HHCS PLTD	2
2A040-061	RETAINER CUP, VORT S/C PLY	1	7F250-021	1/4-20 NYLOCK NUT ZINC PLATED	2
2A042-080	BELT, GATES 20MM, 80T COG	1	7J250-001	1/4 WASHER, SAE, PLTD	4
2D170-171	ASSY, JACKSHAFT, SHORT	1	7P375-250	3/8 X 3/8 X 1/4 MALE BARB TEE	1
4CL116-350	IDLR ASSY, 3.5" DIA 20MM COG, SRT8	1	7PS300-275	REDUCER, BLK 3.0- 2.75	1
4CM010-020	S/C MNTG PLT A, 15-17 HEMI CAR	1	7PS300-300	SLEEVE, BLACK, 3.00D X 3.00	1
4CM010-044	S/C MNTG PLT B, 15-17 HEMI CAR	1	7PS300-301	BUMP HOSE, 3.00D X 3.00L	1
4CM010-050	PULLEY GUARD, 15-17 HEMI CAR	1	7R002-044	#44 SAE TYPE F SS HOSE CLAMP	2
4CM036-360	S/C PULLEY 3.60" 6 GROOVE	1	7R002-048	#48 SAE TYPE F SS HOSE CLAMP	7
4CM100-001	HARDWARE ASSY, S/C MNTG BRKT	1	7R002-056	#56 SAE TYPE F SS HOSE CLAMP	1
4CM100-002	SPACER ASSY, S/C MNTG BRKT	1	7R004-007	STEPLESS CLAMP, 28.6	1
4FH016-150	IDLER PLY, SMOOTH 6RIB 3" FLANGD	1	7U030-218	7/32 VAC HOSE, BUNA-N	5FT
4GR032-032	PLY, JACKSHAFT, C5, 20MM, 32T	1	7U038-000	3/4" HEATER HOSE	1.5FT
4CM112-030	AIR INLET ASSY, 15-17 HEMI CAR 1	1	8H040-175	FILTER, 1.75" I.D., RACE BYPASS	1
7P500-009	1/2" X 90 HOSE BARB UNION	1	5A002-071	MAP SENSOR, 3-BAR, SRT-4	1
7P750-502	REDUCER, 3/4" TO 1/2" COUPLER	1	8D204-064	ASY, MAXFLOW BYPASS VALVE	1
7U030-036	1/2" OIL DRAIN HOSE	2.5FT	8N006-026	HEAT EXCHANGER, CAC SYS	1
8H040-240	AIR FILTER, 15-17 HEMI CAR	1	8N107-200	ASY, W/P MNTG, 15-17 HEMI CAR 1	1
4CM155-020	SPRT ITMS, CAC SYS, 15-17 HEMI 1	1	5W001-141	HARNNESS, AUX W/P, 15-17 HEMI CAR	1
4CM010-060	BRKT, RAD SHROUD, 1.00", CHALL	1	7A250-075	1/4-20 X .75 SHCS PLTD	1
4CM010-070	BRKT, RAD SHROUD, .750", CHALL	2	7F250-021	1/4-20 NYLOCK NUT ZINC PLATED	1
4CM011-012	BRKT, HEAT EXCHANGER, P. SIDE	1	7R003-029	ADEL CLAMP, 1-5/8" ID	1
4CM011-013	BRKT, HEAT EXCHANGER, D. SIDE	1	8F001-405	BOSCH AUX WATER PUMP	1
4CM011-014	BRKT, CAC RESERVOIR, 15-17 HEMI	1	8N201-400	ASY, CAC, SAT, 15-17 HEMI CAR 1	1
4CM011-015	BRKT, CAC, D. SIDE, 15-17 HEMI	1			
4CM011-016	BRKT, CAC, P. SIDE, 15-17 CHALL	1			
4CM011-017	BRKT, CAC, TOP SIDE, 15-17 CHALL	1			
4CM011-018	HORN BRKT, 15-17 HEMI CAR	1			
4CM055-020	RESERVOIR, CAC, 15-17 HEMI	1			
5W001-082	SLEEVE, FLEX BRAID .75" NOM.	8FT			
7A250-050	1/4-20 X .50 SHCS GR8 ZINC PLTD	8			
7A250-051	1/4-20 X .50 HHCS GR5 ZINC PLTD	1			
7A250-075	1/4-20 X .75 SHCS PLTD	2			
7A250-500	1/4-20 X 5 SHCS	4			
7C060-011	M6 X 1.0 X 10 HXHD CL8.8 PLT	1			
7C080-012	M8 X 1.25 X 12MM LOW SHCS	1			
7F006-093	NUT, M6 X 1.0, NYLOCK, PLATED	2			
7F250-021	1/4-20 NYLOCK NUT ZINC PLATED	4			
7J250-001	1/4 WASHER, SAE, PLTD	12			
7J312-000	5/16 FLAT WASHER-SAE	1			
7P375-075	3/4" HOSE BARB UNION, BRASS	1			
7P500-035	FITTING, 1/2 NPT X 3/4 BARB X 45	1			
7P500-078	1/2NPT X 3/4 HOSE FIT STRT	1			
7P750-502	REDUCER, 3/4" TO 1/2" COUPLER	1			
7P750-503	3/4-1/2 REDUCER BARB 90	1			
7R001-006	#6 STNLS HOSE CLAMP, NARROW	4			
7R002-010	#10 SAE TYPE F SS HOSE CLAMP	8			
7R004-007	STEPLESS CLAMP, 28.6	2			
7T100-281	9/32" X 6" LENGTH EXTENDED DRILL	1			
7U030-065	HOSE, 3/4 X 90 ELBOW, SHORT	1			

1. ECU REMOVAL



If you purchased a 'Tuner' supercharger system, it will be up to you to have the ECU unlocked.

- A. Open the trunk and lift the carpet. Remove the positive battery terminal cover from the battery, then proceed to unplug both battery leads.

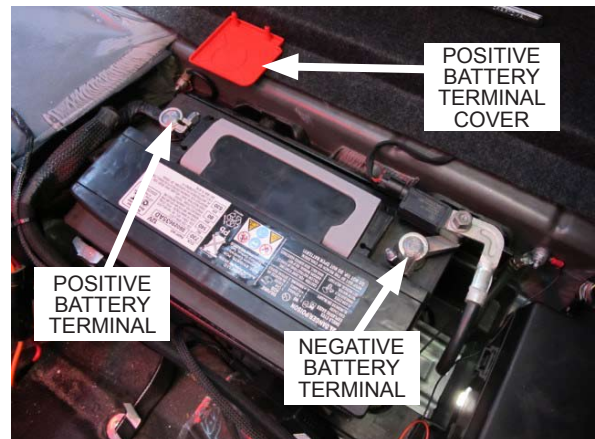

Fig. 1-a: Unplug battery

- B. There are six plastic fasteners that secure the windshield cowl to the cross bar. Using a panel removal tool, remove the six plastic fasteners and set them aside.



Fig. 1-b: Remove plastic fasteners

- C. On the driver side of the engine compartment, near the bottom of the windshield cowl, are two screws that secure the cross bar. Using a 13mm socket, remove the two screws and set them aside.



Fig. 1-c: Remove cross bar screws

1. ECU REMOVAL

- D. On the passenger side of the engine compartment near the windshield cowl is the ECU cover. Using a panel removal tool, remove the two plastic fasteners securing the ECU cover. Set the ECU cover and two plastic fasteners aside.



Fig. 1-d: Remove two plastic fasteners

- E. There are two nuts securing the ECU to its mounting bracket. Using a 10mm wrench, remove the ECU nuts and set them aside. You will notice that the ECU mounting bracket is attached to the cross bar. Using a 13mm socket, remove the two screws securing the cross bar to the vehicle, then proceed to remove the ECU mounting bracket and set it aside, but leave the ECU in the vehicle.

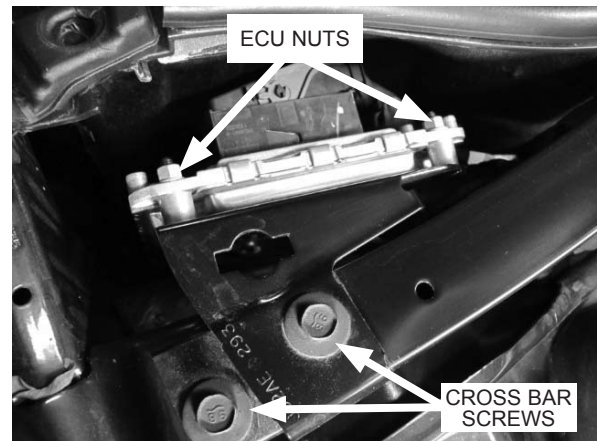

Fig. 1-e: Remove ECU nuts and remove cross bar screws

- F. If you look on the underside of the cross bar, you will notice that the windshield wiper motor is mounted to it using a rubber mount. Now that the cross bar is loose, proceed to remove the cross bar from the vehicle, making sure to remove the windshield wiper motor mount from the underside of the cross bar.

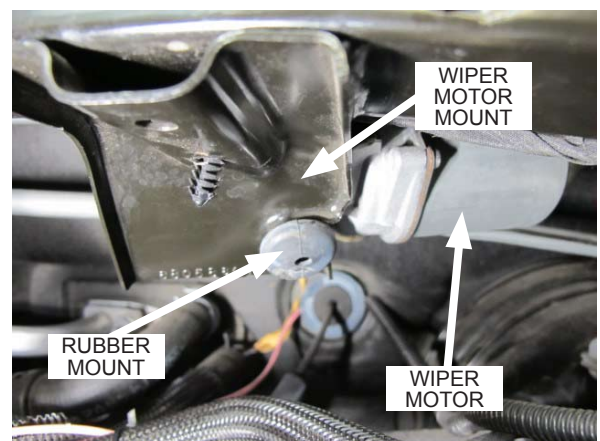

Fig. 1-f: Windshield wiper motor mount

1. ECU REMOVAL

- G. Now that the cross bar is removed, proceed to disconnect both ECU connectors and remove the ECU from the vehicle.

NOTE: In order to be able to tune the vehicle, the ECU will need to be removed and sent out to be unlocked. Refer to **Appendix C** near the back of this manual for ECU mailing instructions.



Fig. 1-g: Disconnect ECU

This page was left intentionally blank.

2. BASIC COMPONENT REMOVAL

- A. Remove the two plastic covers from the top of the front bumper cover by pulling them apart at the center, then set them aside.

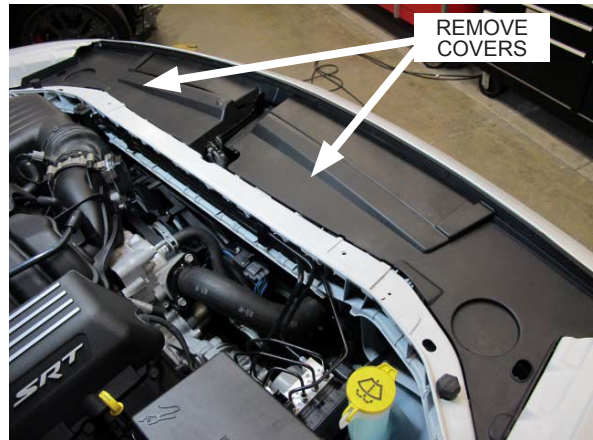

Fig. 2-a: Remove covers

- B. Using a panel removal tool, remove the six plastic fasteners securing the top of the radiator shroud to the vehicle and set aside.

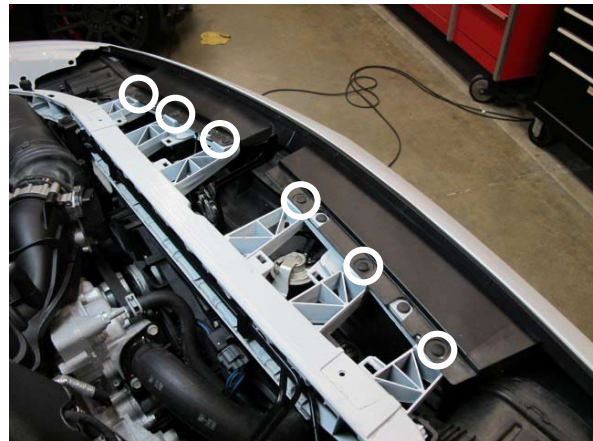

Fig. 2-b: Remove six plastic fasteners

- C. Using a drill motor and an 1/8" drill bit, drill through the center of the plastic rivets securing the fender liner to the front bumper cover. New plastic rivets are provided with this kit. Do this for both sides of the vehicle.



Fig. 2-c: Drill through and remove plastic rivets

2. BASIC COMPONENT REMOVAL

- D. On each side of the vehicle are two plastic fasteners securing the engine service panel to the inner fender liner. Using a panel removal tool, remove these fasteners and set them aside.



Fig. 2-d: Remove two plastic fasteners

- E. Using a panel removal tool, remove the three plastic fasteners securing the front bumper cover to the vehicle and set aside. Next, using a 10mm socket, remove the four screws securing the engine service panel to the vehicle and set aside.



Fig. 2-e: Remove splash guard

- F. Located on each of the top corners of the front bumper cover is a threaded stud that is used to secure the front bumper cover to the fenders using a nut. Using a 10mm socket, remove these nuts and set aside.



Fig. 2-f: Remove two nuts

2. BASIC COMPONENT REMOVAL

- G. There is one screw on each outer edge of the front bumper cover, beneath the fender liner. Pull back the fender liner and using a 10mm socket, remove these screws and set them aside.



Fig. 2-g: Remove screw

- H. On each side of the front bumper cover is another threaded stud that secures the front bumper cover to the fenders using a nut. To gain access to this nut, we suggest pulling back the fender liner, using a long extension, a deep 10mm socket and ratchet to reach this screw. Using the proper tools, remove the nut.

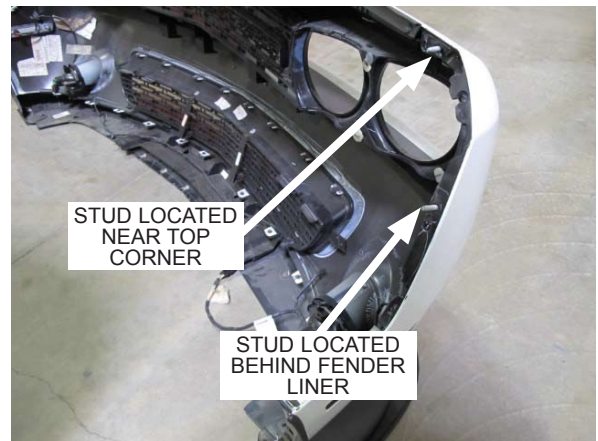

Fig. 2-h: Remove two nuts
(Bumper removed for clarity)

- I. Located on the passenger side behind the front bumper cover is the connector for the fog lights that's mounted to a plastic bracket. Disconnect the fog light connector. Detach the connector from the plastic mounting bracket, then remove the plastic mounting bracket from the vehicle. It will not be reused.

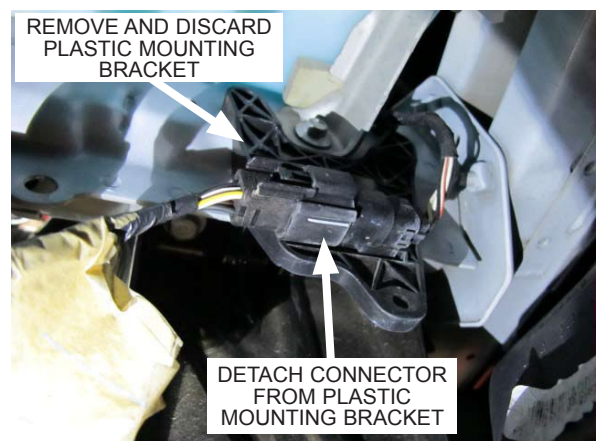

Fig. 2-i: Disconnect fog light connector

2. BASIC COMPONENT REMOVAL

- J. The corners of the front bumper cover typically snap into place on the front fenders. In order to release the front bumper cover from the front fenders, you will need to pull the edges of the front bumper cover away from the fenders with a good amount of force, making sure you have a good grip on the front bumper cover as to not cause any damage. Once released, proceed to remove the front bumper cover from the vehicle and set aside.



Fig. 2-j: Remove front bumper cover

- K. Remove the plastic fasteners securing the plastic bumper guard to the front bumper beam. Remove the bumper guard and set aside.



Fig. 2-k: Remove plastic bumper guard

- L. Remove the ambient air temperature sensor from the radiator shroud and set aside. It will be relocated in a later step.



Fig. 2-l: Remove ambient air temperature sensor

2. BASIC COMPONENT REMOVAL

- M. Using a panel removal tool, remove the four plastic fasteners securing the top section of the radiator shroud to the vehicle and set aside.



Fig. 2-m: Remove radiator shroud and fasteners

- N. **Vehicles with Shaker hood:** Located just behind the weather stripping on each corner of the shaker scoop are four nuts. Using a 10mm socket, remove the four nuts securing the shaker scoop to the shaker base.

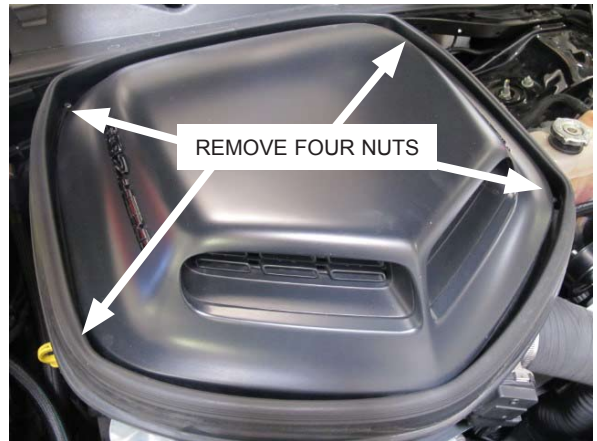

Fig. 2-n: Remove shaker scoop

- O. **Vehicles with Shaker hood:** Using a flathead screw driver, loosen the air inlet hose clamp on the underside of the shaker base.

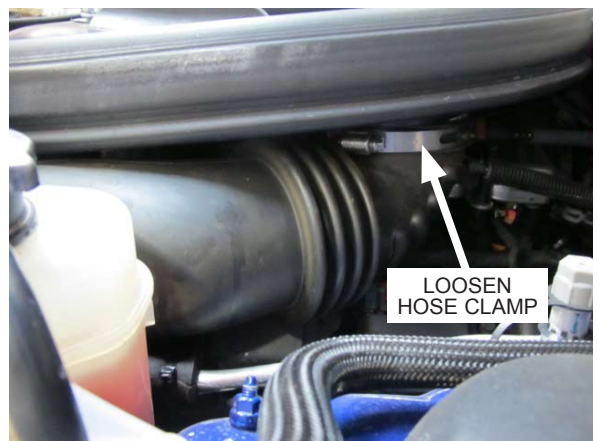

Fig. 2-o: Loosen hose clamp

2. BASIC COMPONENT REMOVAL

- P. **Vehicles with Shaker hood:** Using a 10mm socket, remove the five fasteners securing the shaker base to its mounting bracket on the engine, then remove the shaker base from the vehicle.



Fig. 2-p: Remove shaker base

- Q. **Vehicles with Shaker hood:** Using a 10mm socket, remove the screw securing the air filter enclosure to vehicle. Detach the breather hose from the air filter enclosure, disconnect the IAT sensor and loosen the hose clamp securing the air inlet duct to the throttle body. Remove the air filter enclosure and air inlet duct from the vehicle as they will not be reused. Set the breather hose aside as it will be reused in a later step.

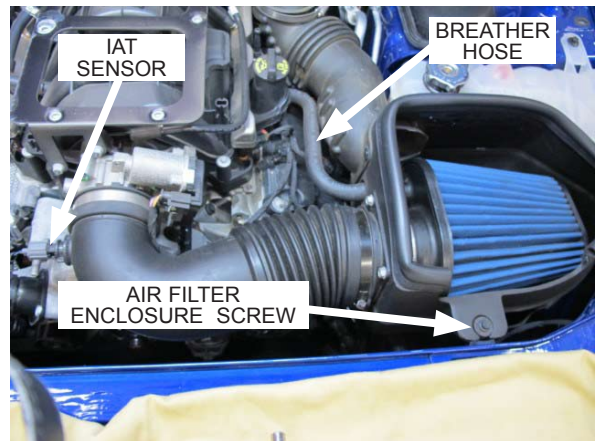

Fig. 2-q: Shaker inlet removal

- R. **Vehicles without Shaker hood:** Remove the engine cover. Using a 10mm socket, remove the screw securing the airbox to the vehicle. Detach the breather hose from the airbox, disconnect the IAT sensor and loosen the hose clamp securing the air inlet duct to the throttle body. Attached to the left side of the air inlet is a resonator, which is attached to a mount using a rubber grommet. Detach the resonator by pulling it up away from its mount, then proceed to remove the airbox and air inlet duct from the vehicle as they will not be reused. Set the breather hose aside as it will be reused in a later step.

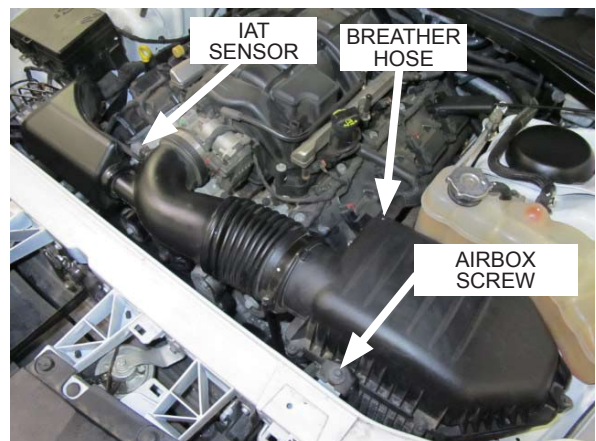

Fig. 2-r: Remove airbox and air inlet duct

2. BASIC COMPONENT REMOVAL

- S. In order to make more working space when pinning the crankshaft in a later step, it will be necessary to remove the radiator fan assembly. There is one screw on each side of the radiator fan assembly. Using a 10mm socket, remove the screws and set aside. Proceed to disconnect the radiator fan connector located on the driver side of the radiator fan assembly.



Fig. 2-s: Remove radiator fan assembly

- T. The radiator rests on the lower radiator support. Since the lower radiator support will be removed in the next step, it will be necessary to secure the radiator to the vehicle. Using zip ties, pass them through the holes on the upper part of the radiator, near the upper radiator alignment brackets, and wrap the zip tie around the core support. Repeat this step for both sides of the radiator.

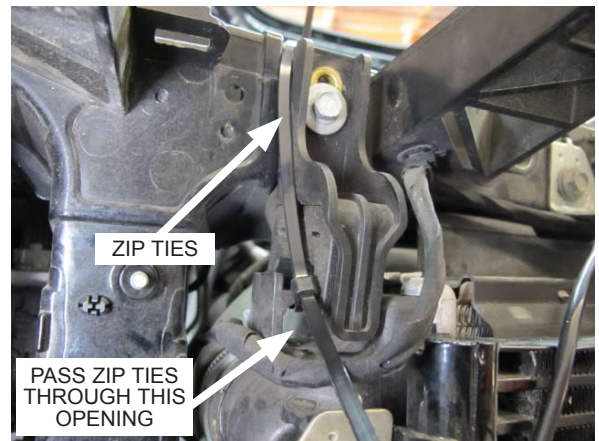

Fig. 2-t: Zip tie radiator to core support

- U. The A/C condenser and radiator fan assembly are attached to the radiator, which is mounted to the lower radiator support. In order to remove the radiator fan assembly from the vehicle, the lower radiator support will need to be removed from the vehicle. Doing this will allow the radiator, A/C condenser, and radiator fan assembly to be lowered and moved forward, away from the engine. Place a floor jack (or a suitable tool) underneath the lower radiator support, then use a 13mm socket and proceed to remove the four screws (two per side) from each side of the lower radiator support. Be sure to remember which side of the lower radiator support is the driver side.

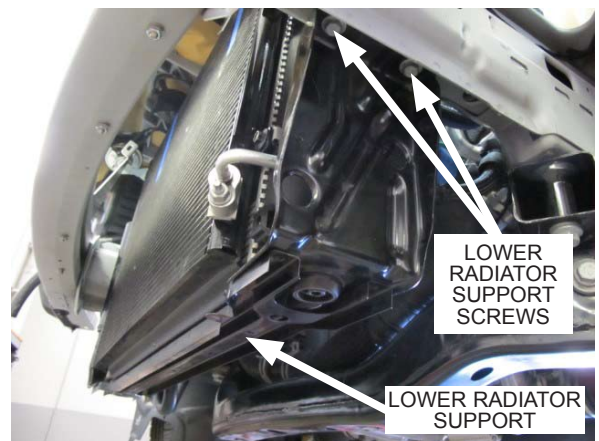

Fig. 2-u: Remove lower radiator support hardware

2. BASIC COMPONENT REMOVAL

- V. Now that the lower radiator support is no longer fastened to the vehicle, proceed to lower the lower radiator support away from the vehicle. Once you have enough room, remove the radiator fan assembly from the radiator and set it aside.

NOTE: The A/C lines will remain attached to the A/C condenser. Be sure to avoid damaging the A/C lines during this process.



Fig. 2-v: Remove radiator fan assembly

- W. Use a long 3/8" ratchet or 3/8" breaker bar to rotate the belt tensioner clockwise to release tension from the 6-rib accessory drive belt. Remove the belt as it will not be reused.

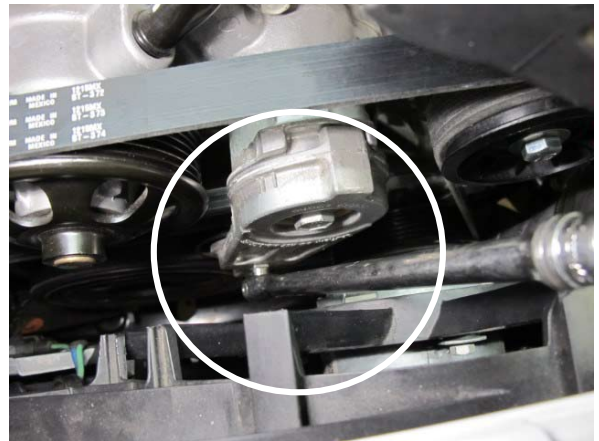

Fig. 2-w: Remove accessory drive belt

- X. Located on the driver side cylinder head is an idler pulley mount assembly. Using a 13mm socket, remove the three screws securing the assembly to the driver side cylinder head. The assembly and hardware will not be reused.

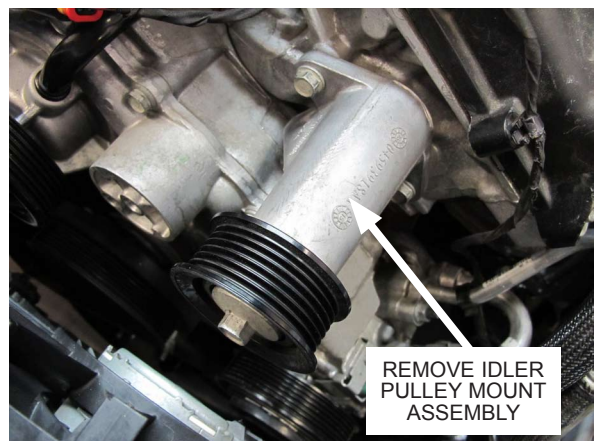

Fig. 2-x: Remove idler pulley mount assembly

3. HARMONIC DAMPER DOWEL PIN INSTALLATION

NOTE: Be sure to avoid damaging the radiator during this section. We suggest temporarily covering the radiator with a piece of cardboard.

- A. Remove the factory crankshaft damper bolt.

NOTE: **M/T Vehicles:** With the wheels on the ground, place the car in 6th gear and apply the parking brake, then proceed to remove the factory crankshaft damper bolt.

A/T Vehicles: Remove the transmission access panel. To lock the engine in place, use a flywheel / flexplate locking tool or a large pry bar to keep the engine from rotating. See Fig. 3-f & Fig. 3-g.

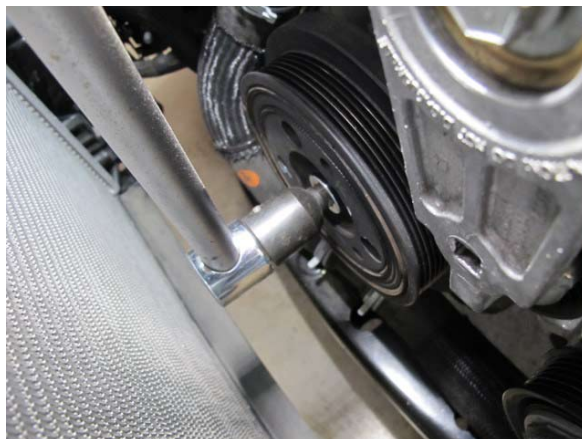

Fig. 3-a: Remove crankshaft damper bolt

- B. Install the supplied drill guide, making sure that the raised section is used as a pilot inside the damper bore. Secure it in place using the supplied socket head cap screw. Do not overtighten the screw as it may distort the drill guide.



Fig. 3-b: Install drill guide

- C. Using a piece of tape or a drill stop, mark your 1/4" drill bit at a point of 2.60" from the tip of the drill bit.

NOTE: Be sure to use a sharp, high quality 1/4" drill bit for this step.

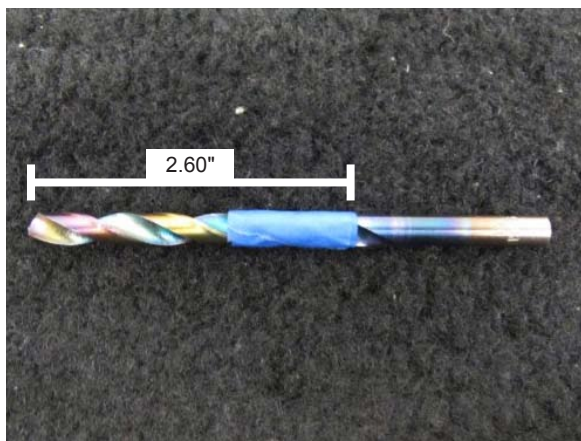

Fig. 3-c: Measure drill bit to 2.60"

3. HARMONIC DAMPER DOWEL PIN INSTALLATION

- D. Using an angle drill or a small drill motor, drill into the crankshaft / damper assembly through the bushing in the drill guide, making sure to keep the tool perpendicular to the damper. Stop when the mark on the drill bit is even with the face of the damper. This will yield a hole depth of 1/2".

NOTE: Periodically stop and allow the drill bit to cool down. Overheating the drill bit may cause it to dull and potentially break. We suggest using cutting oil to ease this step.



Fig. 3-d: Drill crankshaft / damper assembly

- E. Remove the drill guide, then proceed to clean the area/hole of metal chips. Install the supplied dowel pin in the drilled hole, making sure that it doesn't protrude past the damper face.

NOTE: The hole depth should be more than enough to allow the dowel pin to fully seat, however if the dowel pin still protrudes past the damper face, use a small grinding disk to grind down the dowel pin so it is parallel with the face of the damper face.



Fig. 3-e: Install dowel pin

- F. Remove the flywheel access panel by removing the screw using a 10mm socket, then pulling the panel away from the transmission.

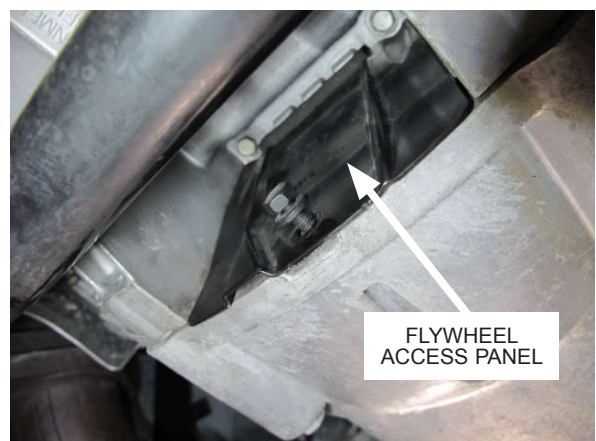

Fig. 3-f: Remove transmission access panel

3. HARMONIC DAMPER DOWEL PIN INSTALLATION

- G. Using a flywheel / flexplate locking tool or a large pry bar, lock the engine in position to keep it from rotating while you torque the crankshaft damper bolt.



Fig. 3-g: Lock engine in position



Use red threadlocker on the crankshaft damper bolt.

- H. With the flywheel / flexplate locked in place, install and tighten the crankshaft damper bolt to 143ft-lbs.



Fig. 3-h: Torque crank bolt

This page was left intentionally blank.

4. LOWER RADIATOR MOUNT MODIFICATION

- A. Reinstall the radiator fan assembly and verify that the electrical connector is plugged in. Secure using the OEM hardware.



Fig. 4-a: Reinstall radiator fan assembly

- B. Locate the lower radiator support. The driver and passenger side rear edge will need to be modified. Be sure to remember which side of the lower radiator support is the driver side.



Fig. 4-b: Lower radiator support

- C. Two holes will need to be drilled on the driver side rear edge of the lower radiator mount. From the bottom edge of the lower radiator support, make a line at 3.25".



Fig. 4-c: Measure 3.25" from bottom edge

4. LOWER RADIATOR MOUNT MODIFICATION

- D. Measuring from the inside edge of the lower radiator support, measure 1/2" and make a line. This will be the location of the first hole.

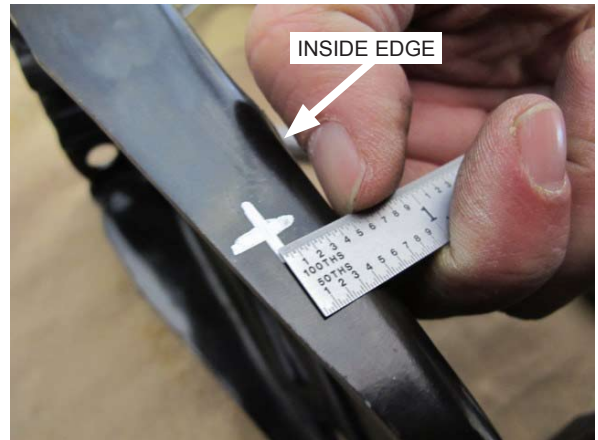

Fig. 4-d: Measure 1/2" from inside edge

- E. Measuring from the first marks, make another line up at 2.00". Lastly, measuring from the inside edge, measure 1/2" and make another line. This will be the location of the second hole.

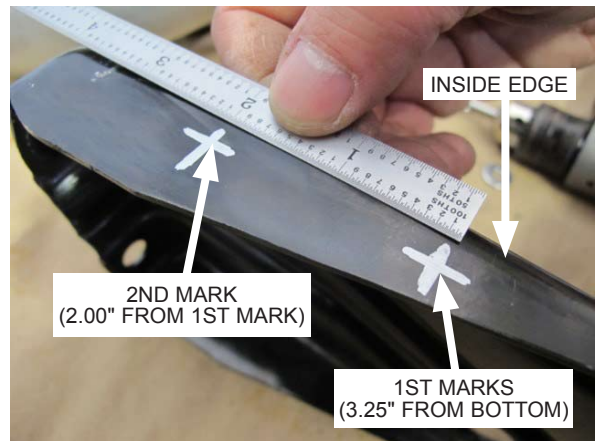

Fig. 4-e: Measure 2.00" up from first marks

- F. With both hole locations marked on the driver side rear edge of the lower radiator mount, use a 9/32" drill bit to drill through the center of both measurements.



Fig. 4-f: Drill holes on driver side rear edge of lower radiator support

4. LOWER RADIATOR MOUNT MODIFICATION

- G. A hole will need to be drilled on the passenger side rear edge of the lower radiator mount. Using the measurements in Fig. 4-j, mark the center of the measurements and use a 9/32" drill bit to drill through the passenger side rear edge of the lower radiator mount.



Fig. 4-g: Drill hole on passenger side rear edge of lower radiator support

- H. After the three holes are drilled and deburred, proceed to reinstall the lower radiator support and secure using the OEM hardware.

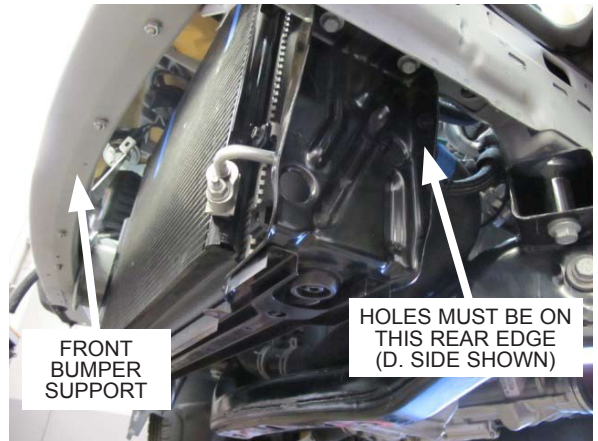

Fig. 4-h: Reinstall lower radiator support

This page was left intentionally blank.

5. S/C MOUNTING BRACKET ASSEMBLY INSTALLATION



Use blue threadlocker on all fasteners in this section.

- A. The supercharger mounting bracket comes preassembled. In order to be able to install the serpentine belt, the pulley guard will need to be removed. Using a 3/16" hex tool, remove the two 1/4"-20 x 1/2" socket head cap screws securing the pulley guard to the supercharger mounting bracket. Set the screws and pulley guard aside. They will be reinstalled in a later step.

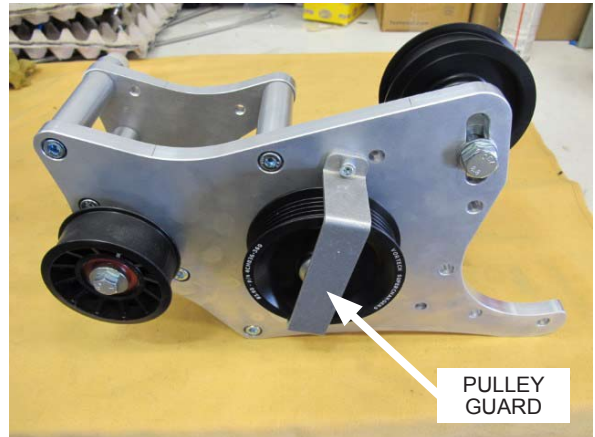

Fig. 5-a: Remove pulley guard

- B. Some of the hardware used to mount the supercharger mounting bracket assembly to the driver side cylinder head is blocked by the serpentine belt idler pulley. Temporarily remove the serpentine belt idler pulley and its hardware and set aside for reinstallation in a later step.



Fig. 5-b: Remove serpentine belt idler pulley

- C. In order to make space for mounting of the supercharger to the supercharger mounting bracket assembly, the cog belt idler pulley and its hardware will need to be removed and set aside for reinstallation in a later step.

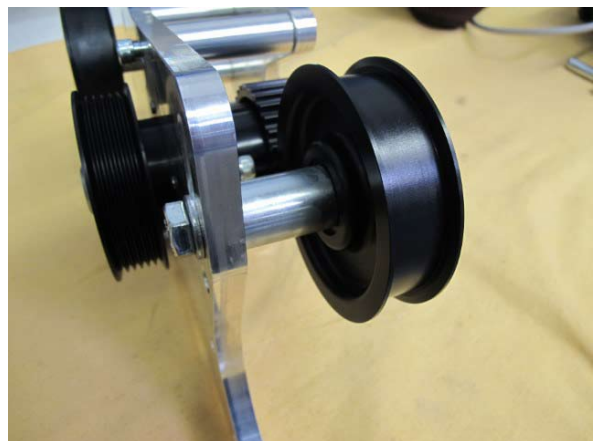

Fig. 5-c: Remove cog belt idler pulley

5. S/C MOUNTING BRACKET ASSEMBLY INSTALLATION

- D. The supercharger mounting bracket assembly will be mounted to the driver side cylinder head using three M8 x 85mm and one M8 x 110mm socket head cap screws. In Fig. 5-d, you will notice a spacer installed to the M8 x 110mm screw. Verify that the spacer installed in this location is the .500" length spacer.

NOTE: There is a .360" length spacer included with this supercharger bracket assembly. Proceed to discard that spacer as it is not used in this application

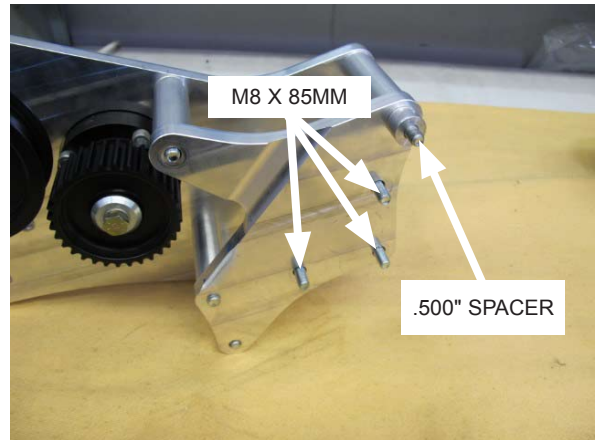

Fig. 5-d: S/C mounting bracket hardware

- E. Remove the harness that is attached to the front of driver side valve cover. Next, you will notice that there are four threaded holes on the driver side cylinder head. The supercharger mounting bracket assembly will be mounted to the driver side cylinder head using these four threaded holes.

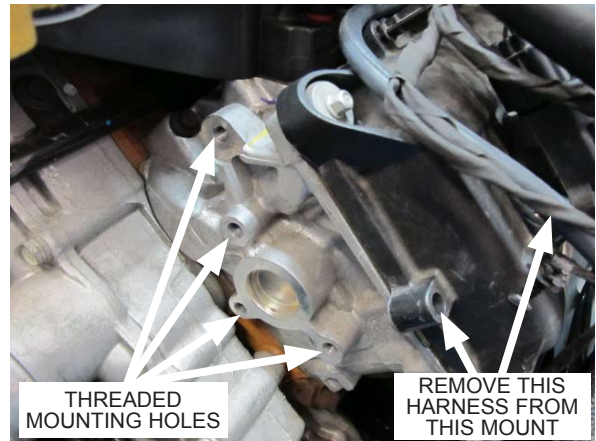

Fig. 5-e: Driver side cylinder head

- F. Place the supercharger mounting bracket assembly in front of the driver side cylinder head. Using a 6mm hex tool, attach the M8 x 110mm socket head cap screw and the .500" length spacer as a pivot on the highest threaded mounting hole on the driver side cylinder head. Be sure that the .500" length spacer is sandwiched between the supercharger mounting bracket assembly & the driver side cylinder head.

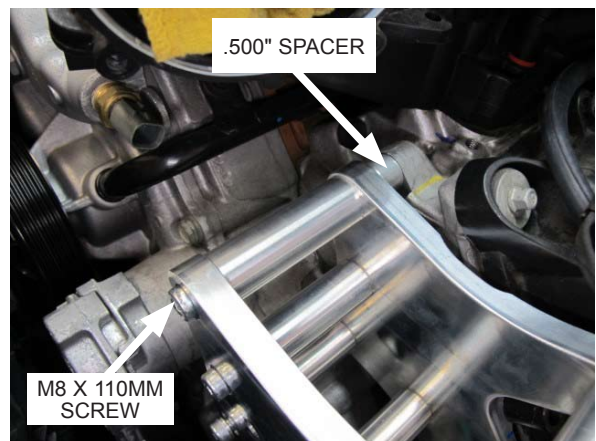

Fig. 5-f: Loosely attach S/C mounting bracket assembly to driver side cylinder head

5. S/C MOUNTING BRACKET ASSEMBLY INSTALLATION

- G. Using a 6mm hex tool, loosely attach the three M8 x 85mm socket head cap screws to the remaining three threaded holes on the driver side cylinder head. Now that all four M8 screws are in place, proceed to secure them to the driver side cylinder head.

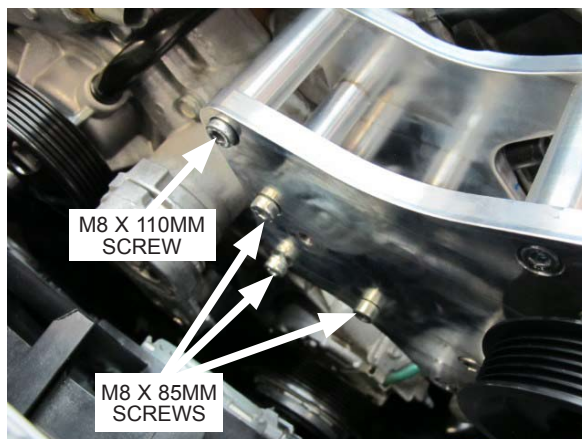

Fig. 5-g: Secure S/C mounting bracket hardware

- H. Locate the previously removed serpentine belt idler pulley and its hardware. Reinstall it to the supercharger mounting bracket assembly, making sure that the hardware is in the same order in which it was removed.

NOTE: If by accident you forget the order of the hardware for the serpentine belt idler pulley, refer to **Appendix A** near the back of this manual for the supercharger mounting bracket assembly diagram.



Fig. 5-h: Reinstall serpentine belt idler pulley

- I. Locate **Appendix B** near the back of this manual for the belt routing diagram and loosely route the provided serpentine drive belt as shown. Once in position, use a 3/8" drive ratchet or 3/8" drive breaker bar and rotate the belt tensioner clockwise, then slide the serpentine drive belt under the smooth idler pulley located on the passenger side of the engine, near the upper radiator hose. Once the belt is in position and properly routed, release the tension on the belt tensioner.

NOTE: The serpentine drive belt will be a tight fit. We suggest having a helper assist you during the installation of the serpentine drive belt.



Fig. 5-i: Slide serpentine belt under OEM passenger side smooth idler pulley

5. S/C MOUNTING BRACKET ASSEMBLY INSTALLATION

- J. Locate the previously removed pulley guard and two 1/4"-20 x 1/2" screws. Using a 3/16" hex tool, reinstall the pulley guard to the super-charger mounting bracket assembly.



Fig. 5-j: Reinstall pulley guard

- K. Using a zip tie, secure the harness removed in step E to the A/C line as shown.

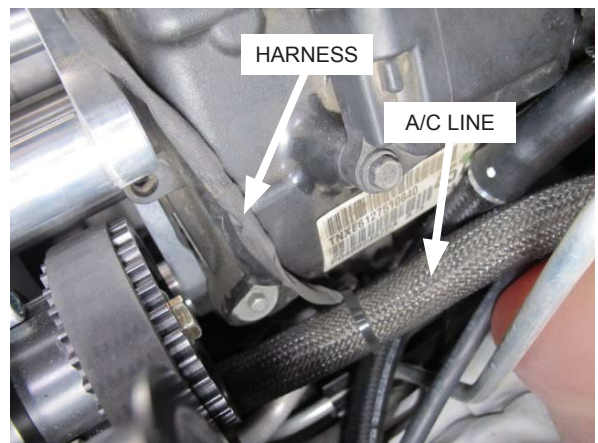

Fig. 5-k: Secure harness to A/C line

6. A/W COOLER, HEAT EXCHANGER & DISCHARGE TUBE INSTALLATION

- A. Locate the air/water cooler, 1/2" NPT x 3/4" barbed straight fitting, and 1/2" NPT x 3/4" barbed 45° fitting and assemble them as shown, making sure the 45° fitting is pointed down. Be sure to use pipe sealant on both threads of the fittings.

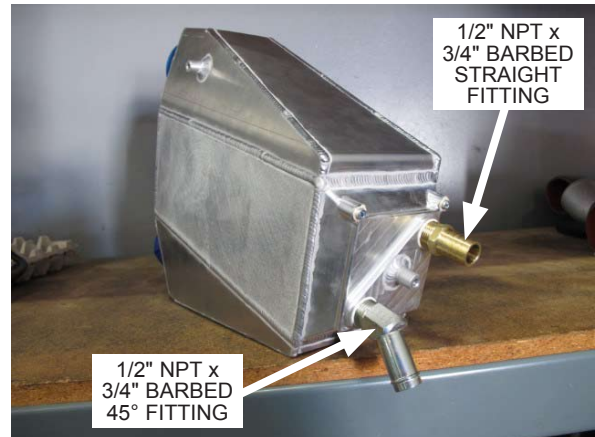

Fig. 6-a: Install fittings to air/water cooler

- B. Before beginning the installation of the air/water cooler, it is necessary to cover the front of the A/C condenser with a large piece of cardboard. Using the box the supercharger kit was shipped in, cut a piece large enough to cover most of the A/C condenser. This helps protect the A/C condenser during installation, but also leaves enough room between the A/C condenser and air/water cooler once the air/water cooler is installed. Use tape to secure the cardboard to the A/C condenser.

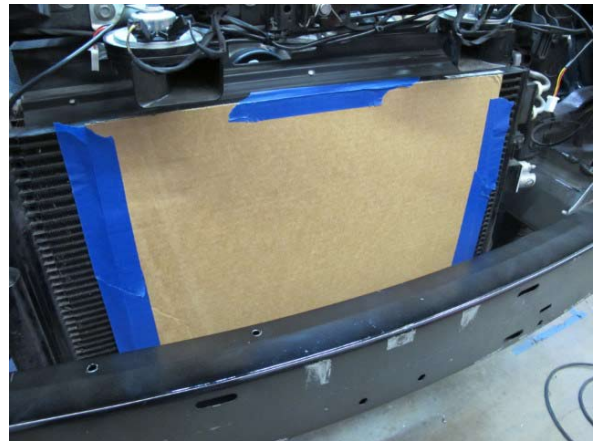

Fig. 6-b: Cover A/C condenser with cardboard

- C. Located on the lower driver side of the radiator is an aluminum bracket that is welded to the condenser. Using a cutting tool, remove the bracket from the condenser, making sure not to damage the condenser in the process. This is done to provide space for the driver side heat exchanger bracket. Next, using an 8mm socket, remove the screw securing the condenser to the radiator.

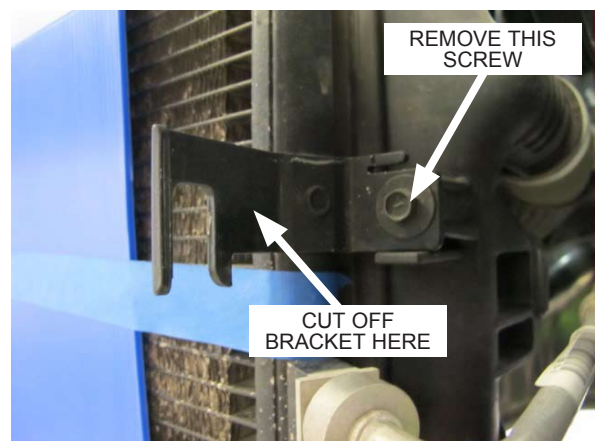

Fig. 6-c: Remove aluminum bracket and screw

6. A/W COOLER, HEAT EXCHANGER & DISCHARGE TUBE INSTALLATION

- D. Located on the lower passenger side of the radiator is another screw. Using a 8mm socket, remove the screw and set it aside.



Fig. 6-d: Remove screw

- E. Locate the provided heat exchanger. The side of the heat exchanger with the two ports is the passenger side of the heat exchanger. Locate the provided passenger side heat exchanger bracket, two 1/4"-20 x .50" screws, and two 1/4" washers. Loosely install the passenger side heat exchanger bracket to the heat exchanger as shown.



Fig. 6-e: Install passenger side heat exchanger bracket

- F. The side of the heat exchanger without any ports is the driver side of the heat exchanger. Locate the provided driver side heat exchanger bracket, two 1/4"-20 x .50" screws, and two 1/4" washers. Loosely install the driver side heat exchanger bracket to the heat exchanger as shown.



Fig. 6-f: Install driver side heat exchanger bracket

6. A/W COOLER, HEAT EXCHANGER & DISCHARGE TUBE INSTALLATION

- G. Using the screw removed in step D, loosely install the passenger side of the heat exchanger assembly to the radiator.



Fig. 6-g: Install passenger side of heat exchanger assembly

- H. Using the screw removed in step C, loosely install the driver side of the heat exchanger assembly to the radiator. Once in position, secure all of the heat exchanger assembly hardware.



Fig. 6-h: Install driver side of heat exchanger assembly

- I. In order to provide space for the upper air/water cooler support bracket, the driver side horn will need to be relocated. Using a 10mm socket, remove the screw securing the driver side horn to the core support. Keep the screw as it will be reused. The wiring harness for the driver side horn is attached to the core support. Using a panel removal tool, remove the harness from the core support.



Fig. 6-i: Remove driver side horn

6. A/W COOLER, HEAT EXCHANGER & DISCHARGE TUBE INSTALLATION

- J. Using a 10mm socket, remove the nut securing the horn bracket to the horn, then discard the horn bracket. It will not be reused. Next, locate the provided horn bracket and install it to the horn as shown. Secure with the previously removed nut.



Fig. 6-j: New horn bracket

- K. Located on the upper passenger side of the radiator is a mounting boss and screw. Using a 8mm socket, remove the screw and relocate the driver side horn to this location. Secure using the same screw.



Fig. 6-k: Relocate driver side horn to upper radiator

- L. Locate the upper air/water cooler support bracket and mount it to the original location of the driver side horn. Secure using the OEM screw.



Fig. 6-l: Install upper air/water cooler support bracket

6. A/W COOLER, HEAT EXCHANGER & DISCHARGE TUBE INSTALLATION

- M. There are two holes located on top of the front bumper support, near the passenger side. In order to secure the passenger side air/water cooler support bracket with the provided hardware, it will be necessary to drill completely through these two holes.



Fig. 6-m: 2x holes on front bumper support

- N. Using the provided 9/32" x 6" length drill bit and a drill motor, drill through both holes on the front bumper support.

NOTE: Periodically stop and allow the drill bit to cool down. Overheating the drill bit may cause it to dull and potentially break. We suggest using cutting oil to ease this step.



Fig. 6-n: Drill through two holes on front bumper support

- O. Using two 1/4"-20 x 5.00" screws, two 1/4"-20 nylock nuts, and four 1/4" washers, Loosely install the passenger side air/water cooler support bracket to the front bumper support.



Fig. 6-o: Loosely install passenger side air/water cooler support bracket

6. A/W COOLER, HEAT EXCHANGER & DISCHARGE TUBE INSTALLATION

- P. Lower the air/water cooler into position and temporarily secure the passenger side of the cooler to the previously installed passenger side air/water cooler bracket using the provided 1/4"-20 x .50" socket head cap screw and 1/4" washer. Leave the screw hand tight at this time.



Fig. 6-p: Temporarily secure passenger side of air/water cooler

- Q. Temporarily secure the top side of the air/water cooler to the previously installed upper air/water cooler support bracket using the provided 1/4"-20 x .50" hex head cap screw and 1/4" washer. Leave the screw hand tight at this time.



Fig. 6-q: Temporarily secure top side of air/water cooler

- R. Locate the provided driver side air/water cooler support bracket and loosely attach it to the driver side of the air/water cooler using the provided 1/4"-20 x .50" socket head cap screw and 1/4" washer. Leave the screw hand tight at this time. In order to secure the driver side air/water cooler support bracket to the front bumper support, two holes will need to be drilled through the front bumper support. Using the driver side air/water cooler bracket as a template, make a mark in the center of both slots.

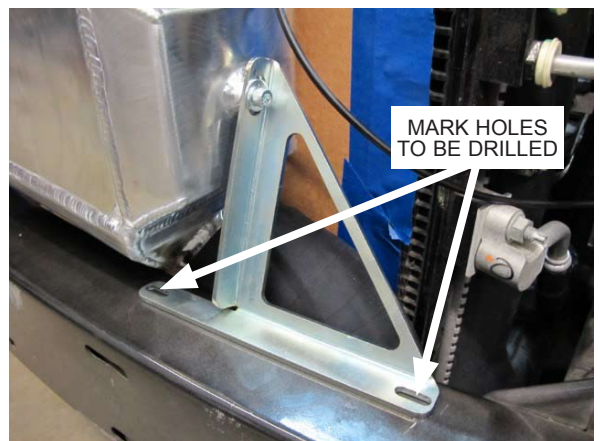

Fig. 6-r: Use driver side air/water cooler support bracket as drill template

6. A/W COOLER, HEAT EXCHANGER & DISCHARGE TUBE INSTALLATION

- S. Remove the air/water cooler from the vehicle, as well as the driver side and upper air/water cooler support bracket. Using the same 9/32" x 6" length drill bit that was used in Step M, drill through the two marked holes, making sure to go all the way through the front bumper support. Once the holes are drilled, loosely install the driver side air/water cooler support bracket using the provided two 1/4"-20 x 5.00" screws, two 1/4"-20 nylock nuts, and four 1/4" washers.

NOTE: Periodically stop and allow the drill bit to cool down. Overheating the drill bit may cause it to dull and potentially break. We suggest using cutting oil to ease this step.

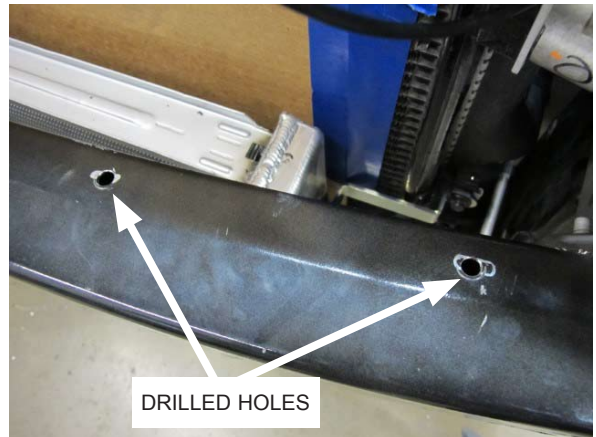

Fig. 6-s: Drill 2x holes using 6" length drill bit

- T. Locate discharge sleeve 'C' (S-shaped) that has two 45° bends in it. Notice one end of the sleeve is cut at an angle. The angled end of the sleeve will be installed to the air/water cooler. Keep this in mind for the next step.



Fig. 6-t: Discharge sleeve 'C'

- U. Orient the air/water cooler as shown. Notice that the 45° fitting on the passenger side is pointed down. Loosely install a straight Ø3.00" silicone sleeve and #48 hose clamp onto the inlet of the air/water cooler. Next, loosely install discharge sleeve 'C' and #44 hose clamp to the outlet of the air/water cooler, making sure that the angled end of discharge sleeve 'C' sits flush with the air/water cooler.



Fig. 6-u: Install silicone sleeves to air/water cooler as shown

6. A/W COOLER, HEAT EXCHANGER & DISCHARGE TUBE INSTALLATION

- V. With the air/water cooler support brackets loosely installed on the vehicle, slide the air/water cooler into position. Discharge sleeve 'C' will be routed behind the front bumper support, then down under driver side frame rail. Once discharge sleeve 'C' is in position, proceed to secure the air/water cooler to all of the air/water cooler support brackets, then proceed to tighten all of the support bracket hardware. Make sure that the air/water cooler isn't being pressed into the A/C condenser. Adjust as necessary, then remove the cardboard that was used to protect the A/C condenser.

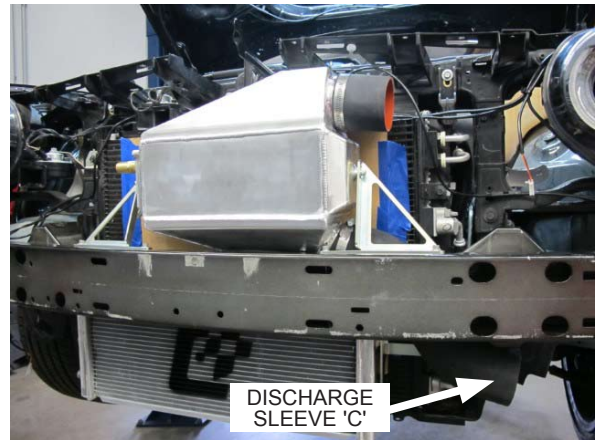

Fig. 6-v: Install air/water cooler

- W. Locate discharge tube 'D'. Route the long end of the tube up into the engine compartment, as close to the radiator fan shroud as possible. Loosely install the short end of the tube into discharge sleeve 'C'.



Fig. 6-w: Loosely install discharge tube 'D'

- X. Line up the mounting bracket on discharge tube 'D' with the two previously drilled holes on the lower radiator support and secure using two 1/4"-20 x .50" screws, two 1/2"-20 nylock nuts, and four 1/4" washers.

NOTE: The holes on the bracket that's welded to discharge tube D are slotted to allow for adjustment of the tube if necessary.



Fig. 6-x: Secure discharge tube 'D' to lower radiator support

6. A/W COOLER, HEAT EXCHANGER & DISCHARGE TUBE INSTALLATION

- Y. Locate the factory air inlet tube and remove the intake air temperature sensor. Next, locate discharge sleeve 'E' (with molded boss). Insert the intake air temperature sensor into the molded boss, making sure that the alignment tab on the intake air temperature sensor is inserted into the alignment slot on the molded boss. Once in position, secure using the provided 28.6 stepless clamp.



Fig. 6-y: Install IAT sensor to molded boss on discharge sleeve 'E'

- Z. Install discharge sleeve 'E' to discharge tube 'D' and to the throttle body, making sure that discharge sleeve 'E' is not rubbing against any sharp edges or pressed against the pulley guard on the supercharger mounting bracket assembly. Once in position, secure using a #48 and #56 hose clamp, then reconnect the IAT sensor located on the passenger side of the discharge sleeve.



Fig. 6-z: Install discharge sleeve 'E' and reconnect IAT sensor

- AA. Locate discharge tube 'B' and install the bypass valve and filter as shown. Secure the bypass valve to the discharge tube using the two 1/4"-20 x .750" socket head cap screws provided with the bypass valve.



Fig. 6-aa: Install bypass valve to discharge tube 'B'

6. A/W COOLER, HEAT EXCHANGER & DISCHARGE TUBE INSTALLATION

- AB. Install the end of discharge tube 'B' without the bypass valve to the air/water cooler. Leave the hose clamps loose at this time.



Fig. 6-ab: Install discharge tube 'B'

- AC. Using a $\text{Ø}3.00$ silicone bump sleeve and two #48 hose clamps, loosely install discharge tube 'A' to discharge tube 'B', making sure to route discharge tube 'A' up into the engine compartment. Leave the hose clamps loose at this time.



Fig. 6-ac: Loosely install discharge tube 'A' to discharge tube 'B'

- AD. Locate the previously removed ambient air temperature sensor. On the back side of the sensor mount, there is a locating tab that needs to be grinded down. Proceed to grind down the locating tab, then using an M6 x 10mm screw and 1/4" washer, secure the ambient air temperature sensor to the underside of the front bumper support, near the passenger side.



Fig. 6-ad: Reinstall ambient air temperature sensor as shown

7. AIR INLET ASSEMBLY, BYPASS VALVE SIGNAL HOSE & S/C INSTALLATION

- A. Locate the provided air filter. With the 90° plastic fitting installed into the air filter, place the air filter into the vehicle as shown. Next, install a $\text{Ø}3.00$ to $\text{Ø}2.75$ " silicone reducer sleeve, one #48 hose clamp, and one #44 hose clamp to the other end of discharge tube 'A'. Leave the hose clamps loose at this time.

NOTE: The air filter must be in place prior to the supercharger being installed, as it is not possible to install the air filter after the supercharger is installed.



Fig. 7-a: Place air filter into position and install silicone sleeve to discharge tube 'A'

- B. Prior to installing the supercharger to the supercharger mounting bracket assembly, it is suggested that you lubricate the threads in the mounting bosses on the supercharger. To do this, use four 3/8-16 x 1.25" screws and lightly coat the screw threads with lubricant, then screw them into the mounting bosses until they bottom out. Once complete, remove the screws from the mounting bosses. This process makes it easier to install the screws into the supercharger.



Fig. 7-b: Lubricate supercharger mounting boss threads



Use blue threadlocker on all fasteners in this step.

- C. Place the supercharger onto the supercharger mounting bracket assembly and begin to thread the four 3/8-16 x 1.25" supercharger mounting screws by hand, making sure to use 3/8" washers on all screws. Once in position, proceed to tighten the four 3/8-16 x 1.25" supercharger mounting screws.



Fig. 7-c: Install supercharger to supercharger mounting bracket assembly

7. AIR INLET ASSEMBLY, BYPASS VALVE SIGNAL HOSE & S/C INSTALLATION

- D. Locate the previously removed cog belt idler pulley and its hardware and reinstall it to the supercharger mounting bracket assembly, making sure that the hardware is in the same order in which it was removed. Slide the cog belt over both cog pulleys and under the cog belt idler pulley. Using the cog belt idler pulley as a belt tensioner, push it down so it starts to tension the cog belt, then secure the cog belt idler pulley hardware.

NOTE: Do not apply excessive tension to the cog belt. By design, cog belts do not require the same amount of tension as a serpentine belt. Under the correct amount of tension, you should be able to easily "twist" the straight section of the cog belt about a 1/4 turn.



Fig. 7-d: Tension cog belt

- E. Locate the OEM breather hose. The end of the hose that was attached to the intake manifold is wider than the end of the hose that was attached to the airbox. In this application, the end of the hose that was attached to the intake manifold needs to be shortened. Measuring from the inside bend of the hose, trim the hose down to a length of 4.75".



Fig. 7-e: Modify OEM breather hose

- F. Locate the provided 3/4" to 1/2" reducer fitting and 1/2" oil drain hose. Cut the 1/2" oil drain hose to a length of 25". Insert the 1/2" end of the reducer fitting into the 1/2" oil drain hose, then install the modified OEM breather hose to the 3/4" end of the reducer fitting as shown. No hose clamps are required for this step.



Fig. 7-f: Breather hose assembly

7. AIR INLET ASSEMBLY, BYPASS VALVE SIGNAL HOSE & S/C INSTALLATION

- G. Install the breather hose assembly as shown. Route the breather hose assembly under the A/C lines, then over towards the air filter. Attach the breather hose assembly to the 1/2" x 90° fitting on the air filter. No hose clamps are required for this step.



Fig. 7-g: Install breather hose assembly

- H. Proceed to install the air filter to the supercharger inlet and secure using the hose clamp provided with the air filter. Next, proceed to install discharge tube 'A' to the supercharger outlet, but do not tighten the hose clamps at this time.

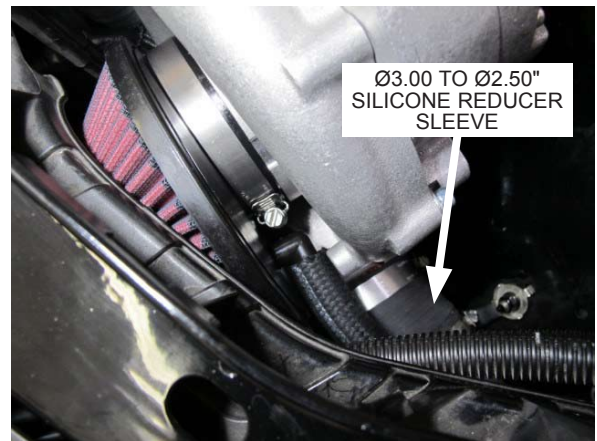

Fig. 7-h: Secure air filter and discharge tube A to supercharger

- I. With all discharge tubes and sleeves installed, verify that they are free and clear of any obstructions and adjust as necessary. Once in place, proceed to tighten all hose clamps using a 5/16" nut driver or flathead screw driver.



Fig. 7-i: Secure discharge tubes and discharge sleeves

7. AIR INLET ASSEMBLY, BYPASS VALVE SIGNAL HOSE & S/C INSTALLATION

- J. There is a 3/8" vacuum line attached to the brake booster. Cut the 3/8" vacuum line and install the provided brass vacuum tee. Locate the provided 7/32" vacuum hose and attach it to the vacuum tee, then route the vacuum line along the fuel injector harness, then under the supercharger and down towards the bypass valve on discharge tube 'B'.

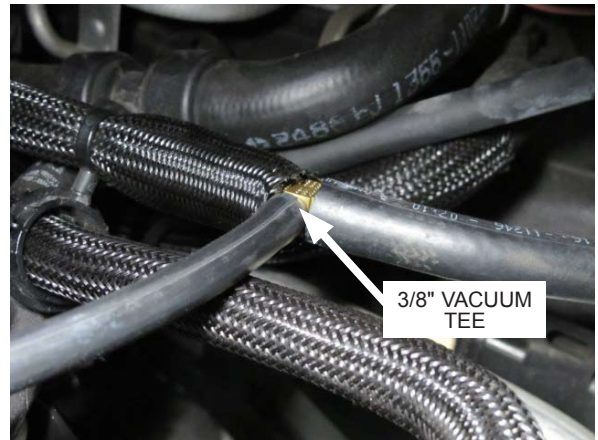

Fig. 7-j: Install vacuum tee

- K. Attach the 7/32" vacuum hose to the fitting located on the bypass valve lid.



Fig. 7-k: Attach vacuum hose to bypass valve

8. A/W COOLING SYSTEM INSTALLATION

- A. Locate the provided auxiliary water pump harness. You will notice one end of the harness has a 10A fuse tap attached to it. Verify that this fuse is not damaged as it will replace a fuse in the fuse box in a later step.



Fig. 8-a: Auxiliary water pump harness

- B. Using a 5/8" drill bit, drill through the back of the fuse box cover as shown. Pass the fuse tap through the hole, then secure the rubber grommet to the fuse box cover.



Fig. 8-b: Drill fuse box cover, install grommet and route wire into fuse box

- C. On the under side of the fuse box cover is a fuse diagram. Locate and remove fuse #37, then replace it with the fuse tap as shown. Reinstall the fuse box cover, then route the harness down towards the passenger side of the lower radiator support making sure to keep it away from sharp edges and moving objects.



Fig. 8-c: Install fuse from water pump harness as shown

8. A/W COOLING SYSTEM INSTALLATION

- D. In order to provide clearance for the auxiliary water pump, the plastic fastener for the large harness connector will need to be removed. Disconnect the large harness connector, then using a pry tool, remove the large harness connector from its mounting location.

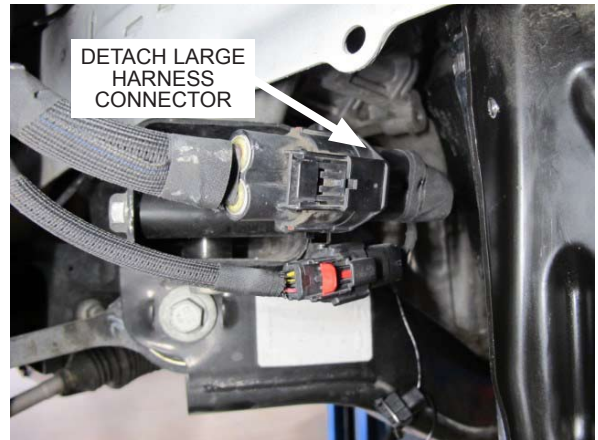

Fig. 8-d: Large harness connector

- E. Remove the plastic harness connector fastener from the connector and discard. It will not be reused. Reconnect the large harness connector at this time.



Fig. 8-e: Remove plastic harness connector fastener

- F. Using zip tie, secure the large harness connector to its original mount. Next, using an adel clamp, one 1/4"-20 x .50" socket head cap screw, one 1/4"-20 nylock nut, and one 1/4" washer, loosely mount the auxiliary water pump to the hole previously drilled on the passenger side of the lower radiator mount, making sure to place the ring terminal from the auxiliary water pump harness between the 1/4"-20 nylock nut and 1/4" washer. Position the auxiliary water pump so the outlet is positioned as shown. Once in position, connect the auxiliary water pump harness to the water pump.

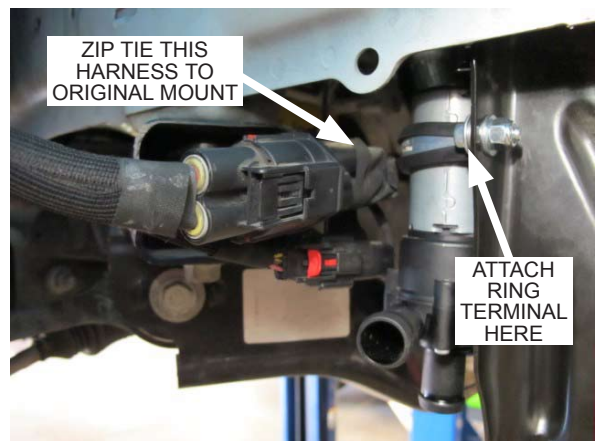

Fig. 8-f: Install the auxiliary water pump

8. A/W COOLING SYSTEM INSTALLATION

- G. In order to provide room for one of the air/water cooling system hoses that gets attached to the heat exchanger, one of the front bumper support screws will need to be removed.



Fig. 8-g: Remove front bumper support screw

- H. Locate the provided M8 x 1.25 x 12mm socket head cap screw and install it where the previously removed front bumper support screw was located.



Fig. 8-h: Shorter front bumper support screw

- I. Locate both of the provided 3/4" x 150° molded hoses. Prior to being installed, they'll need to be modified. Using a pair of hose cutters, remove 1.00" from the short end of both hoses and 1/2" from the long end of both hoses.

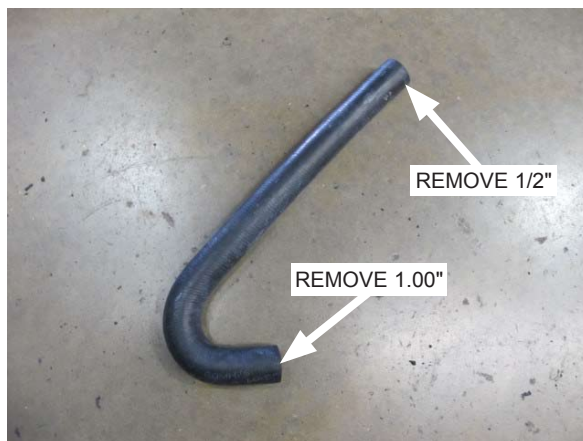

Fig. 8-i: Modify 150° molded hose as shown

8. A/W COOLING SYSTEM INSTALLATION

- J. Using one of the modified 3/4" x 150° molded hoses, attach the short end of the hose to the upper port of the heat exchanger. Loosely attach a #10 hose clamp, but do not tighten it at this time.



Fig. 8-j: Install short end of 150° molded hose to heat exchanger

- K. Attach the other end of the modified 150° molded hose to the 45° fitting on the air/water cooler core. Once the hose is in position, proceed to secure this end of the hose with another #10 hose clamp. Be sure to secure the #10 hose clamp installed in the previous step.



Fig. 8-k: Install long end of 150° molded hose to air/water cooler

- L. Using a 13mm socket, remove the nuts that secure the shock mount to the shock tower on the passenger side. Next, locate the provided mounting bracket for the air/water cooling system reservoir and install it as shown, then secure it using the same nuts that secure the shock mount to the shock tower.



Fig. 8-l: Install air/water cooler system reservoir mount

8. A/W COOLING SYSTEM INSTALLATION

- M. Locate the provided air/water cooling system reservoir and install it to the previously installed mount on the shock tower. Secure using the provided M6 nylock nuts and M6 washers.



Fig. 8-m: Install air/water cooler system reservoir to mount

- N. Locate the provided length of 3/4" coolant hose and cut it down to 44". Next, locate the braided sleeve and cut a 57" piece. As you begin to slide the braided sleeve over the 3/4" coolant hose, it will begin to increase in diameter, thus shortening its overall length. Center the braided sleeve on the 3/4" coolant hose and use electrical tape to secure both ends. There should only be a few inches of coolant hose exposed on each end.



Fig. 8-n: 44" length of the 3/4" coolant hose

- O. Locate the provided 1/2" x 90° hose elbow. Measuring from the inside of the 90° bend, cut each leg down to 1.50".

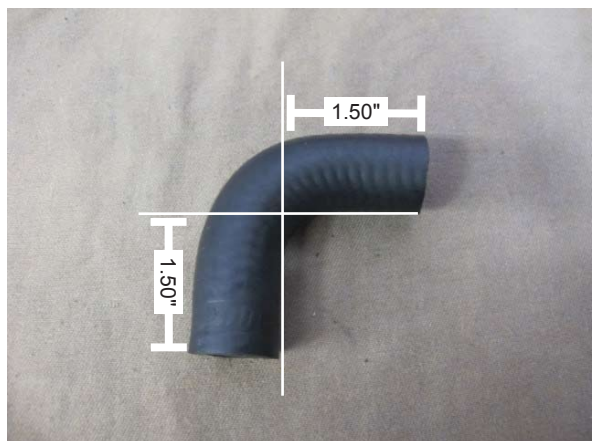

Fig. 8-o: Modify 1/2" x 90° coolant elbow as shown

8. A/W COOLING SYSTEM INSTALLATION

- P. Locate the provided 3/4" x 1/2" x 90° brass reducer fitting and insert the 1/2" end of the fitting into one of the legs of the 1/2" x 90° hose.



Fig. 8-p: Insert brass fitting to 1/2" x 90° coolant hose elbow

- Q. Install the hose and brass fitting assembly to the plastic bung on the rear of the air/water cooling system reservoir and secure using two #6 hose clamps.



Fig. 8-q: Install hose and brass fitting assembly to air/water cooling system reservoir

- R. Locate the 44" length of 3/4" hose and attach one end of the hose to the brass fitting as shown. Secure using a #10 hose clamp.



Fig. 8-r: Attach 44" length of 3/4" coolant hose to the brass fitting as shown

8. A/W COOLING SYSTEM INSTALLATION

- S. Route the 3/4" coolant hose from the air/water cooling system reservoir towards the air/water cooler, making sure to keep it away from the exhaust manifold, as well as sharp and/or moving objects. Secure using provided zip ties.



Fig. 8-s: Route 3/4" coolant hose towards air/water cooler

- T. Pass the 3/4" coolant hose between the radiator and the core support. Make sure the hose doesn't get pinched or kinked.



Fig. 8-t: Pass 3/4" coolant hose between radiator and core support

- U. Attach the 3/4" coolant hose to the straight fitting on the air/water cooler and secure using the provided #10 hose clamp.



Fig. 8-u: Attach 3/4" coolant hose to air/water cooler

8. A/W COOLING SYSTEM INSTALLATION

- V. Locate the provided 3/4" x 90° molded hose. You will notice that one leg of the molded hose is shorter than the other. Loosely install the short leg of the molded hose to the lower port of the heat exchanger. Route the long leg of the hose towards the outlet of the auxiliary water pump and trim the hose down to size, making sure it is not kinked and clear of any sharp edges. Secure the molded hose using two #10 hose clamps. Once this hose is properly installed, go back and tighten the hardware securing the water pump to the lower radiator mount.

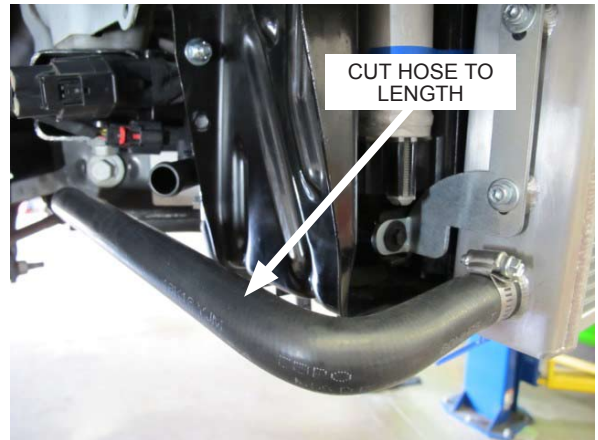

Fig. 8-v: Install 3/4" x 90° hose

- W. Locate the remaining 3/4" x 150° molded hose, 3/4" to 1/2" reducer fitting, 1/2" coolant hose, one #10 hose clamp, one #6 hose clamp, and braided sleeve. Cut the 1/2" coolant hose to 27.5", then cut the braided sleeve to 32". Use the 3/4" to 1/2" reducer fitting to join both hoses together, then secure them using the two hose clamps. Once the hose is assembled, slide the braided sleeve over the 1/2" coolant hose. As you begin to slide the braided sleeve over the 1/2" coolant hose, it will begin to increase in diameter, thus shortening its overall length. Center the braided sleeve on the 1/2" coolant hose and use electrical tape to secure both ends. There should only be a few inches of coolant hose exposed on each end.



Fig. 8-w: 3/4" x 150° to 1/2" coolant hose assembly

- X. Loosely install the 3/4" x 150° molded hose and a #10 hose clamp to the inlet of the auxiliary water pump. With the hose in properly routed, proceed to secure the hose to the electric water pump inlet using the #10 hose clamp. Once this end of the coolant hose assembly is secured, route the other end of this hose up towards the air/water coolant reservoir.



Fig. 8-x: Install coolant hose to electric water pump inlet

8. A/W COOLING SYSTEM INSTALLATION

- Y. Using the coolant hose assembly from the previous step, install the 1/2" end of the coolant hose assembly and a #6 hose clamp to the air/water system coolant reservoir, making sure to keep it away from the exhaust manifold, as well as sharp and/or moving objects. Secure using provided zip ties.

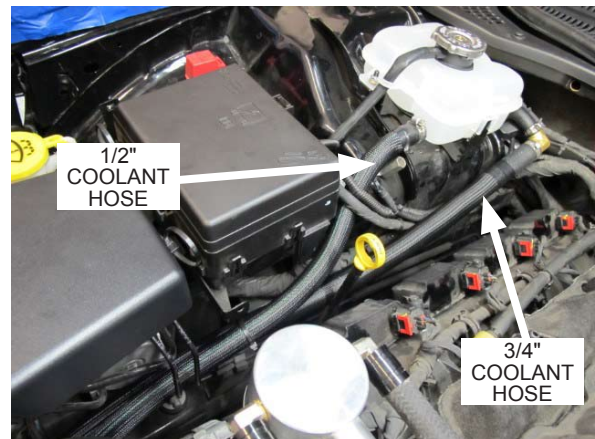

Fig. 8-y: Install coolant hose assembly and route towards electric water pump

- Z. Verify that all hose clamps for the air/water cooling system are secured, then begin to fill the air/water cooling system at the reservoir with 50/50 water/coolant mix. Check for leaks and correct if necessary. In order to properly purge the air/water system of air, the electric water pump needs to be turned on. To do this, the battery will need to be plugged back in and the vehicle turned to *RUN* mode, but **DO NOT START THE ENGINE**. To put the vehicle into *RUN* mode, **KEEP YOUR FOOT OFF OF THE BRAKE AND/OR CLUTCH**, then press the engine start button twice. This will turn on all vehicle accessories as well as turn on the electric water pump for the air/water cooling system. Continue to fill the air/water cooling system until all of the air has been purged. Only fill the air/water coolant reservoir to the line labeled *COLD FULL LEVEL*. Install reservoir cap once complete, then unplug the the battery again.



Fig. 8-z: Fill air/water cooling system with 50/50 water/coolant mix

This page was left intentionally blank.

9. RADIATOR SHROUD MODIFICATION & INSTALLATION

- A. Locate the 1.00" width radiator shroud bracket and one rubber mount. Insert the rubber mount to the hole on the radiator shroud bracket. Next, remove the screw to the left side of the hood latch mount using a 10mm socket. Place the radiator shroud bracket in front of the hood latch mount and loosely secure the previously removed hood latch screw.

NOTE: Notice that the radiator shroud brackets are slotted. This is to allow for further adjustment in a later step.



Fig. 9-a: 1.00" width radiator shroud bracket with rubber mount

- B. Locate the one of the 3/4" width radiator shroud brackets and one rubber mount. Insert the rubber mount to the hole on the radiator shroud bracket. Using a 10mm socket, remove the screw securing the passenger side upper radiator mount. Place the radiator shroud bracket in front of the passenger side upper radiator mount and loosely secure the previously removed screw. Repeat this step for the driver side upper radiator mount.

NOTE: Notice that the radiator shroud brackets are slotted. This is to allow for further adjustment in a later step.



Fig. 9-b: 3/4" width radiator shroud bracket with rubber mount

- C. Now that the air/water cooler is installed in front of the radiator, the radiator shroud will need to be modified.



Fig. 9-c: Radiator shroud

9. RADIATOR SHROUD MODIFICATION & INSTALLATION

- D. On the back side of the radiator shroud, you will notice a plastic rib that runs across the full length of the top side of the radiator shroud. Using a cutting tool, cut all across the full length of the radiator shroud, just below the rib shown in Fig. 9-d. Only the top section of the radiator shroud will be used.

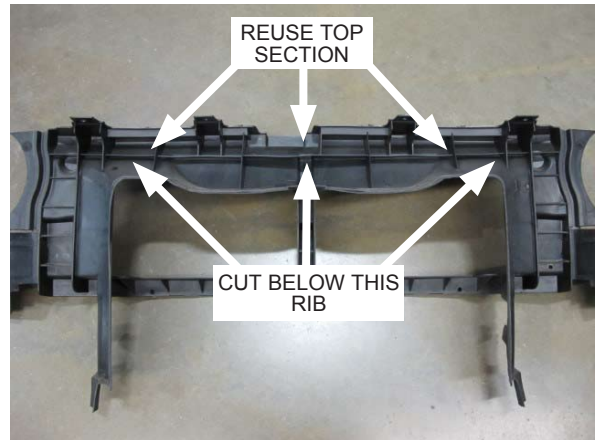

Fig. 9-d: Modify radiator shroud

- E. In order to properly install the modified radiator shroud, it will need to be clearanced so it can clear the top of the air/water cooler. Test fit the modified radiator shroud and make clearance adjustments as necessary.



Fig. 9-e: Modified radiator shroud to air/water cooler clearance

- F. Once the modified radiator shroud clears the air/water cooler, reinstall the modified radiator shroud and secure using the OEM plastic push pins. Next, position all three radiator shroud brackets so they are pressing up on the modified radiator shroud from the underside. Once they are in position, use a 10mm wrench to tighten the three screws securing the radiator shroud brackets. This will add support to the modified radiator shroud as the top side of the front bumper cover rests on top of the modified radiator shroud.

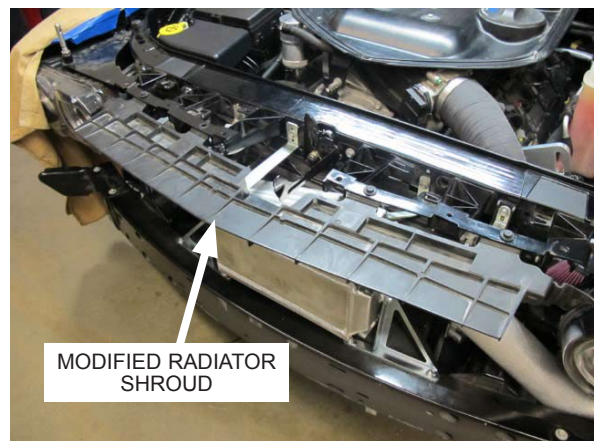

Fig. 9-f: Secure modified radiator shroud and three radiator shroud brackets

10. MISC. REASSEMBLY

- A. Due to possible interference from the discharge tubes and the electric water pump for the air/water cooling system, it may be necessary to remove the front brake cooling ducts, depending on your vehicle. Test fit the front bumper cover and check for front brake cooling duct interference. If there is interference, proceed to remove both front brake cooling ducts. They will not be reused.



Fig. 10-a: Front brake cooling ducts

- B. Reinstall the front bumper cover, reconnect the fog lights, reinstall the engine service panel, and reposition the fender liners. Since the fender liners were originally riveted in place using plastic rivets, replacement plastic rivets have been provided.



Fig. 10-b: Reinstall front bumper cover

- C. Locate the six provided plastic rivets. Using a rivet gun, resecure the fender liners to the front bumper cover using three rivets per side. If a rivet gun is not available to you, simply hold down the base of the plastic rivet using a pair of pliers, then pull the center of the plastic rivet towards you using another pair of pliers. Once you feel them snap into place and secure the fender liner, simply cut off the excess material from the plastic rivet.



Fig. 10-c: Resecure using provided plastic rivets

10. MISC. REASSEMBLY

- D. **Vehicles without Shaker hood:** It will be necessary to modify the engine cover to allow clearance for the IAT sensor connector. Test fit the engine cover and modify as necessary.

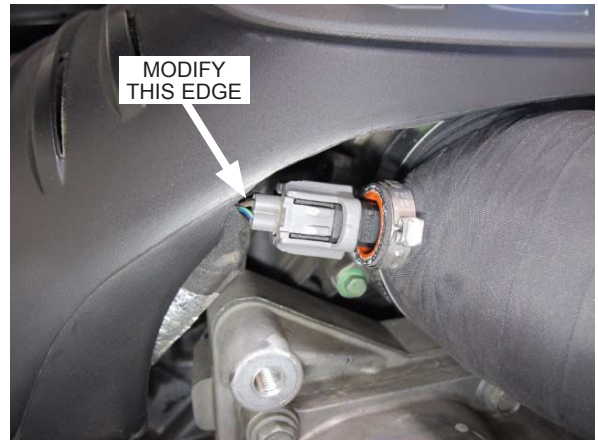

Fig. 10-d: Modify passenger side engine cover

- E. **Vehicles without Shaker hood:** Once the engine cover has been modified, proceed to reinstall the engine cover.



Fig. 10-e: Reinstall the engine cover

- F. **Vehicles with Shaker hood:** Proceed to reinstall the shaker base and shaker scoop. Resecure using all previously removed hardware.



Fig. 10-f: Reinstall shaker base and shaker scoop

11. FINAL CHECK

WARNING: Do not attempt to operate the vehicle until all components are installed and all operations are completed including the final check.

- A. If your vehicle has gone over 15,000 miles since its last spark plug change, you will need to change the spark plugs now *before* test driving the vehicle.
- B. Check all fittings, nuts, bolts and clamps for tightness. Pay particular attention to oil and fuel lines around moving parts, sharp edges and exhaust system parts. Make sure all wires and lines are properly secured with clamps or tie-wraps.
- C. Check all fluid levels, making sure that your tank(s) is/are filled with 91 octane or higher fuel before commencing test drive.
- D. Start the engine and allow to idle a few minutes, then shut off.
- E. Recheck to be sure that no hoses, wires, etc. are near exhaust headers or moving parts. Look also for any signs of fluid leakage.
- F. **PLEASE TAKE SPECIAL NOTE:** Operating the vehicle without ALL the subassemblies completely and properly installed may cause **FAILURE OF MAJOR COMPONENTS.**
- G. Test drive the vehicle.
- H. Always listen carefully for engine detonation. Discontinue heavy throttle usage if detonation is heard.
- I. Read the **STREET SUPERCHARGER SYSTEM OWNER'S MANUAL AND RETURN THE WARRANTY REGISTRATION FORM** within thirty (30) days of purchasing your supercharger system to qualify.

For internally lubricated V3 units only

This supercharger has been factory pre-filled with special Vortech synthetic lubricant. Oil does not need to be added to a brand new unit; however a fluid level check should be performed.

Prior to operating the supercharger on the vehicle and after installation onto the vehicle:

Remove the factory installed flat-head brass shipping plug (not the dipstick) from the top of the supercharger case. Replace the sealed shipping plug with the supplied "vented" plug. Do not operate the supercharger without it. Check the supercharger fluid level.

Fluid level checking procedure:

1. Ensure that the .06" copper sealing washer is located on the dipstick base.
2. Thread the clean dipstick into the unit until it seats.
3. Once the dipstick has seated, remove the dipstick from the unit. Fluid should register in the crosshatched area on the dipstick.
4. **DO NOT OVERFILL!!!** Drain excess fluid from the unit if it is above the maximum level on the dipstick.

Check the fluid level using the dipstick at least every 2,500 miles.

Initial supercharger fluid change must be performed at 2,500 miles. The supercharger fluid must be changed at least every 7,500 miles.

Drain the fluid, refill the unit with 4 oz. of Vortech V3 synthetic lubricating fluid and then confirm proper oil level using the dipstick. **DO NOT OVERFILL!!!**

WARNING: Use of any other fluid other than the special Vortech/Paxton synthetic lubricant will void the warranty and may cause component failure.

APPENDIX A. DIAGRAM, ASSEMBLY, SUPERCHARGER MOUNTING BRACKET

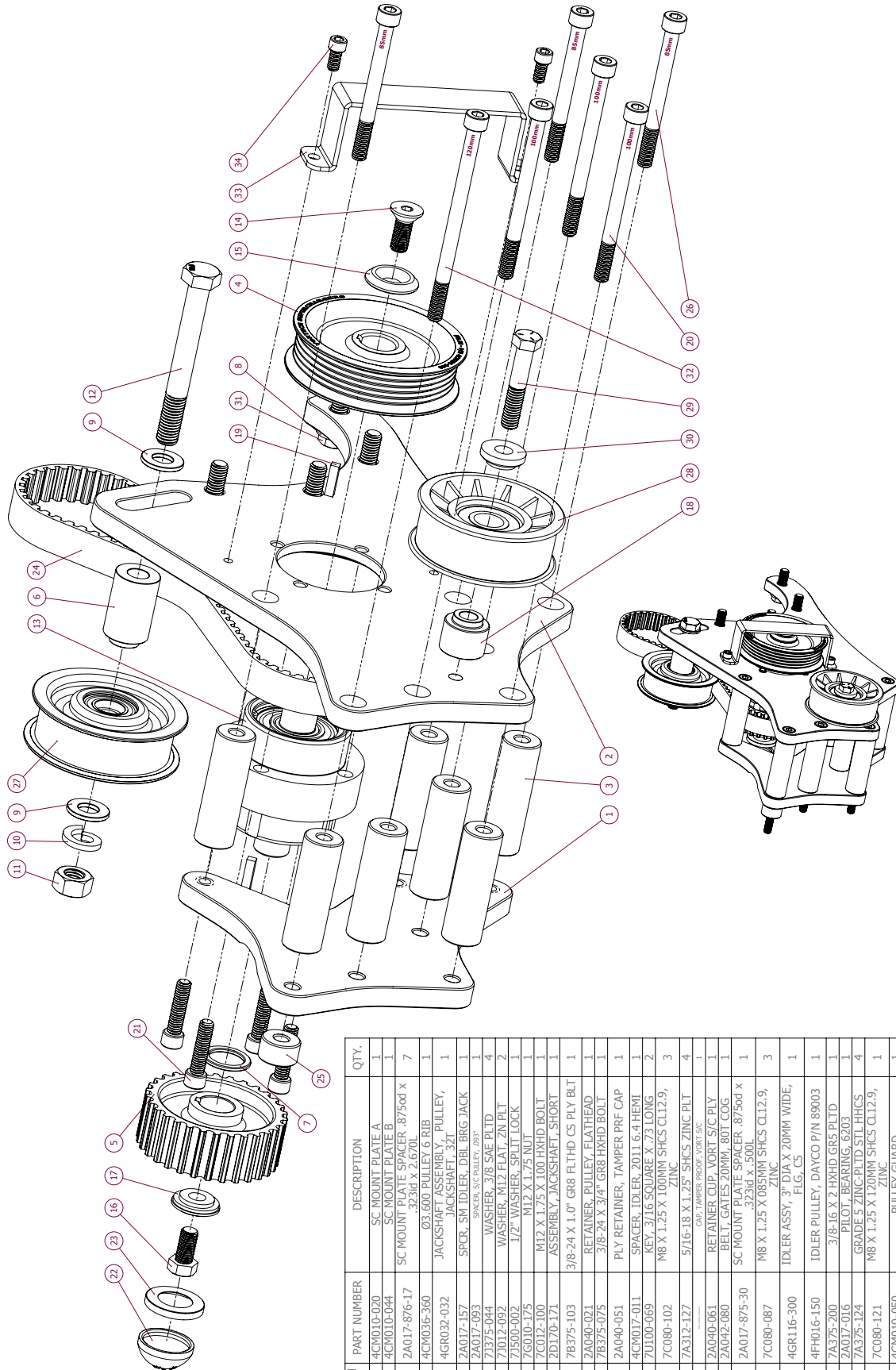

ITEM NO.	PART NUMBER	DESCRIPTION	QTY.
1	4CM010-020	SC MOUNT PLATE A	1
2	4CM010-044	SC MOUNT PLATE B	1
3	2A017-876-17	SC MOUNT PLATE SPACER .8750d x .323id x 2.670L	7
4	4CM0366-360	.03.600 PULLEY 6 RIB	1
5	4GR032-032	JACKSHAFT ASSEMBLY, PULLEY, JACKSHAFT, 32T	1
6	2A017-157	SPCR, SM IDLER, DBL BRG JACK	1
7	2A017-093	SPKERS, SC PALLEY, .037	4
8	71375-044	WASHER, 3/8 SAE PLTD	2
9	71012-092	WASHER, M12 FLAT, ZN PLT	1
10	71500-002	1/2" WASHER, SPLIT LOCK	1
11	7G010-175	M12 X 1.75 X 100 HXHD BOLT	1
12	7C012-100	M12 X 1.75 X 100 HXHD BOLT	1
13	2D170-171	ASSEMBLY, JACKSHAFT, SHORT	1
14	7B375-103	3/8-24 X 1.0" GR8 FLTHD CS PLY BLT	1
15	2A040-021	RETAINER, PULLEY, FLATHEAD	1
16	7B375-075	3/8-24 X 3/4" GR8 HXHD BOLT	1
17	2A040-051	PLY RETAINER, TAMPER PRF CAP	1
18	4CM017-011	SPACER, IDLER, 2011 6.4 HEMI	1
19	7U100-069	KEY, 3/16 SQUARE X .73 LONG	2
20	7C080-102	M8 X 1.25 X 100MM SHCS CL12.9, ZINC	3
21	7A312-127	5/16-18 X 1.25" SHCS ZINC PLT	4
22	2A040-061	RETAINER CUP, VORT 5/C PLY	1
23	2A042-080	BELT, GATES 20MM, 80T COG	1
24	2A042-080	SC MOUNT PLATE SPACER .8750d x .323id x .500L	1
25	2A017-875-30	M8 X 1.25 X 065MM SHCS CL12.9, ZINC	3
26	7C080-087	IDLER ASSY, 3" DIA X 20MM WIDE, FLG, CS	1
27	4GR116-300	IDLER PULLEY, DAYCO P/N 89003	1
28	4FH016-150	3/8-16 X 2 HXHD GR5 PLTD	1
29	7A375-200	PILOT, BEARING, 6203	1
30	2A017-016	GRADE 5 ZINC-PLTD STL HHCS	4
31	7A375-124	M8 X 1.25 X 120MM SHCS CL12.9, ZINC	1
32	7C080-121	PULLEY GUARD	1
33	4CM010-050	1/4-20 X .50" SHCS ZINC PLT	2
34	7A250-050		

APPENDIX B. DIAGRAM, BELT ROUTING

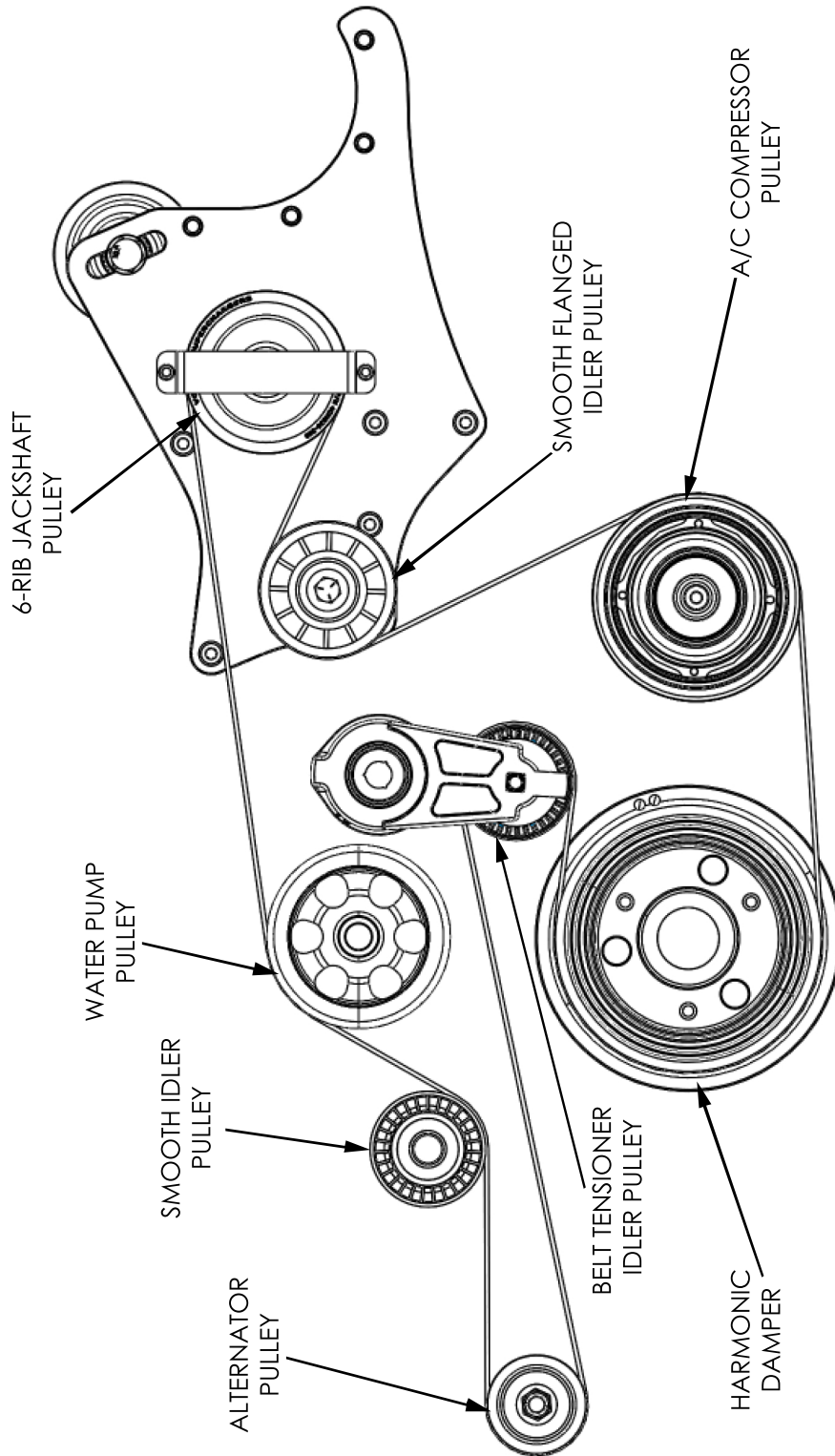



ENGINEERING, INC

1650 Pacific Avenue, Channel Islands, CA 93033-9901 • Phone (805) 247-0226
Fax: (805) 247-0669 • www.vortechsuperchargers.com • M-F 7:00 AM - 3:30 PM (PST)