

advanced FLOW engineering Cold Air Intake System

Instruction Manual P/N: 54-13076R / 54-13076D

Make: Dodge	Model: Challenger SRT Demon	Year: 2018	Engine: V8-6.2L(sc)
Make: Dodge	Model: Challenger SRT Hellcat Redeye	Year: 2019-2023	Engine: V8-6.2L(sc)
Make: Dodge	Model: Challenger SRT Hellcat	Year: 2019-2023	Engine: V8-6.2L(sc)
Make: Dodge	Model: Challenger SRT Super Stock	Year: 2020-2023	Engine: V8-6.2L(sc)



- Please read the entire instruction manual before proceeding.
- Ensure all components listed are present.
- If you are missing any of the components, call customer support at 951-493-7185.
- Ensure you have all necessary tools before proceeding.
- Do not attempt to work on your vehicle when the engine is hot.
- Retain factory parts for future use.

Label	Qty.	Description	Part Number
A	1	Air Filter (Pro 5R) For 54-13076R	24-90110
A	1	Air Filter (Pro DRY S) For 54-13076D	21-90110
B	1	Tube, Plastic	05-5413076B1
C	1	Housing, Plastic	05-5413076B2
D	1	Scoop, Plastic	05-5413021B3
E	1	Coupling, Silicone Bellows	05-01495
F	1	Clamp, #72	03-50010
G	1	Clamp, #64	03-50006
H	1	Seal, Double bulb (42 Inches Long)	05-01534
J	1	Seal, Double bulb (20 Inches Long)	05-01534
K	1	Silicone Hose 1/2" ID (20 Inches Long)	05-01396
M	1	Elbow Fitting	03-50165
N	1	Easy-install Snap-Grip Clamp	03-50648
P	2	Spring Clamp, 15/16" Hose	03-50646
Q	1	Fitting, Air Temp Sensor	05-01454
R	1	Rubber Grommet	03-50167

Installation will require the following tools:

8mm nut driver or 8mm socket and ratchet, razor blade and pliers.

Warranty Information available at: <https://afepower.com/contact#warranty>

Emissions Disclaimer: This product is not currently CARB exempt and is not available for purchase in California or for use on any vehicle registered with the California Department of Motor Vehicles.

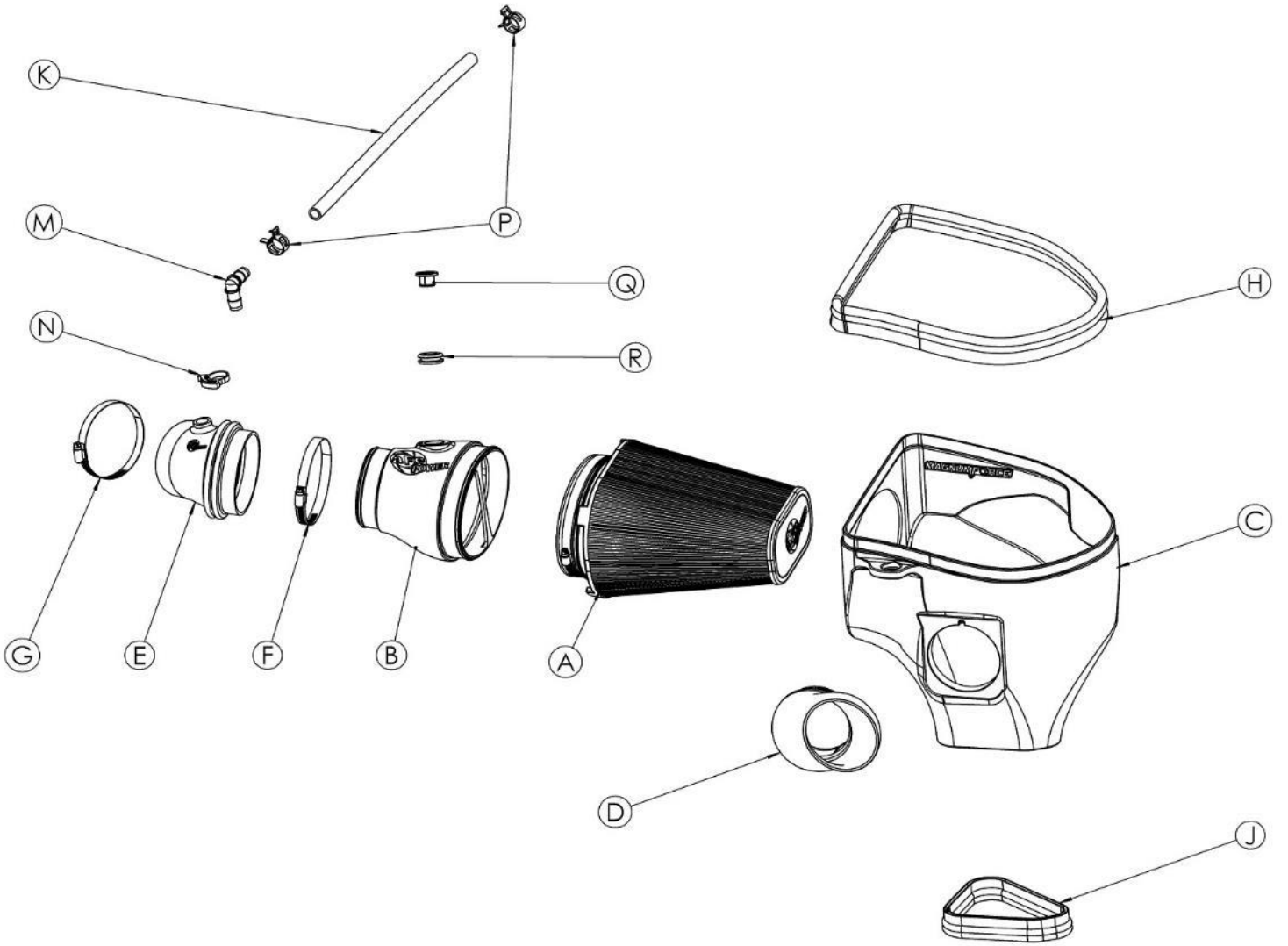

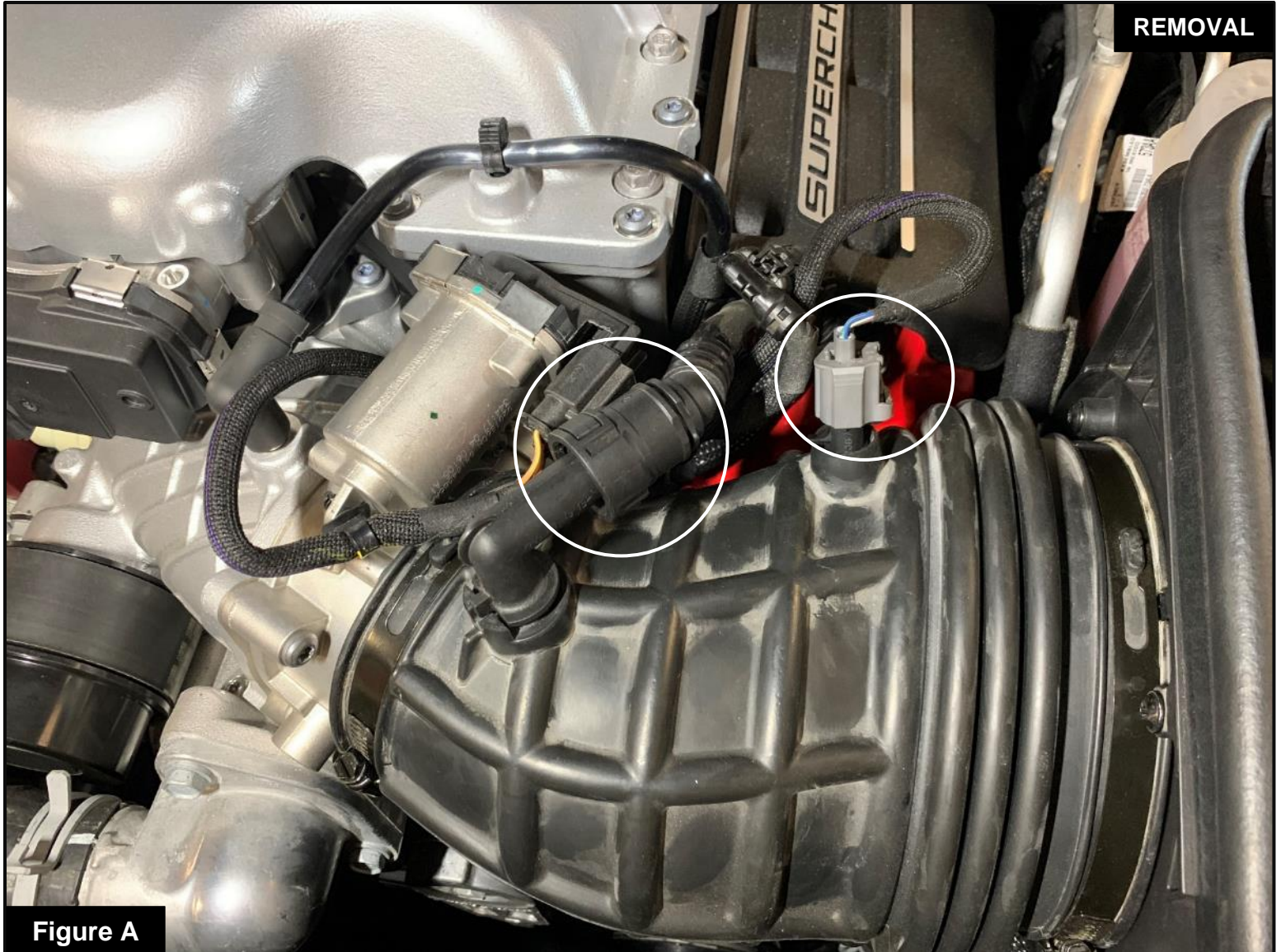

Refer to Figure A for Steps 1-2

Step 1: Disconnect the temperature sensor from the engine harness.

Step 2: **(For SRT Demon only)** Disconnect the 90 degree fitting from the PCV hose.



Refer to Figure B for Steps 3-4 (For SRT Hellcat Redeye and Hellcat Only)

Step 3: **(For SRT Hellcat Redeye and Hellcat Only)** Remove MUA cover if present. Slice the plastic line connected to MUA system. Try to make the cut as clean as possible, if you ever need to reinstall the factory intake in the future. We suggest to use heat-shrink sleeve to cover the cut if needed.

Step 4: **(For SRT Hellcat Redeye and Hellcat Only)** Disconnect the plastic hose from the MUA system. A silicone hose is provided to connect the aFe POWER tube to the MUA system.

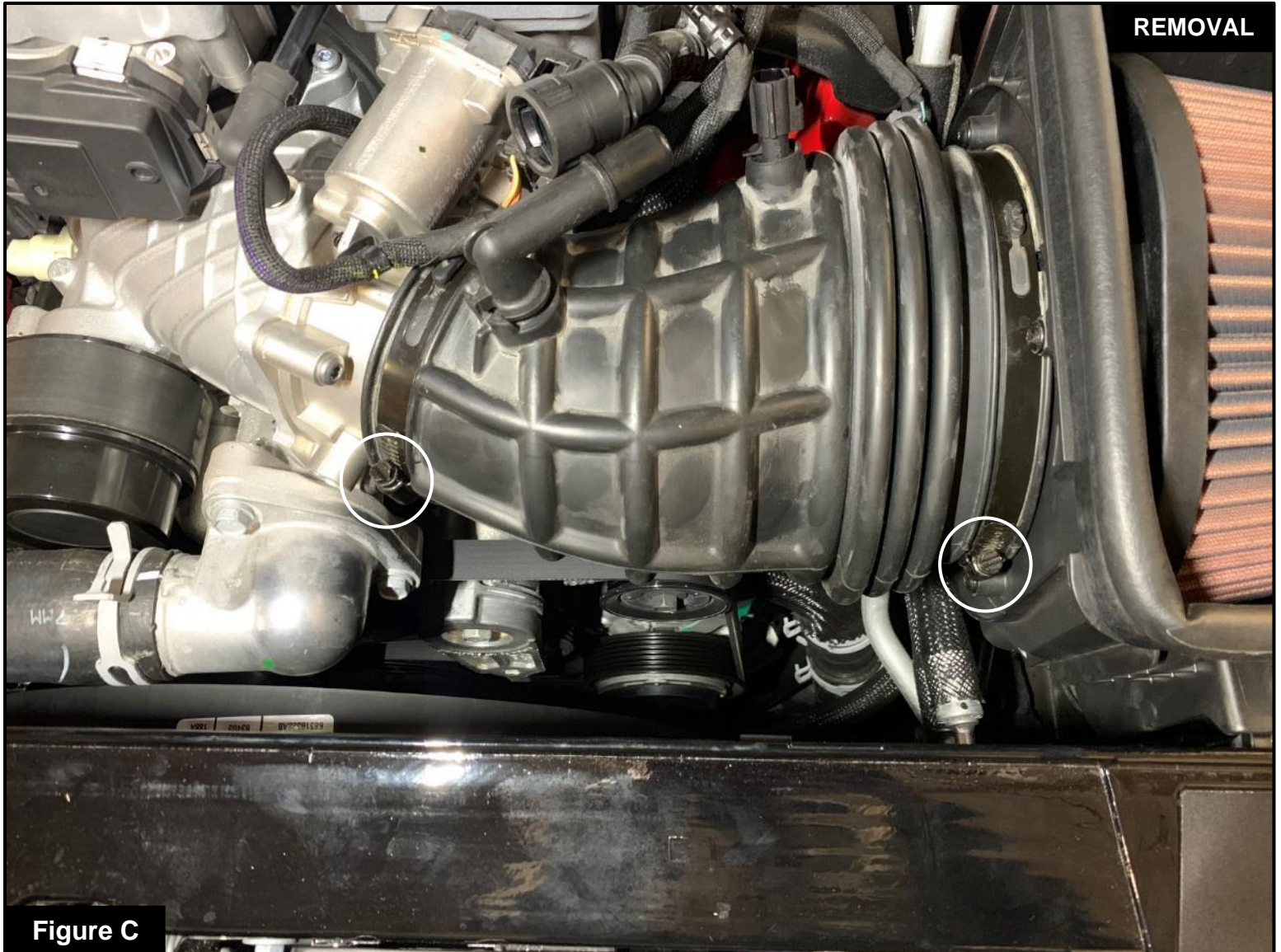

Figure C

Refer to Figure C for Steps 5-6

Step 5: Using an 8mm nut driver, Loosen the two clamps securing the factory intake tube.

Step 6: Remove the factory intake tube from the vehicle. For the SRT Hellcat Redeye and SRT Hellcat, the tube will be come with the solid plastic line disconnected from the MUA system.



Figure D

Refer to Figure D for Steps 7-8

Step 7: Remove the 8mm bolt securing the factory airbox.

Step 8: Remove the factory airbox and scoop from the vehicle as one piece.

**Figure E****Refer to Figure E for Steps 9-11**

Step 9: Transfer the metal sleeve and grommet from the factory airbox to the aFe POWER airbox.

Step 10: Install the provided longer trim seal around the top edge of the airbox and the shorter trim seal on the bottom edge of the airbox.

Step 11: Install the aFe POWER dynamic air scoop (D.A.S) into the airbox.



Refer to Figure F for Step 12

Step 12: Install the aFe POWER airbox into the vehicle. Do not install the 8mm bolt yet.



Figure G

Refer to Figure G for Step 13

Step 13: Install the air filter into the aFe POWER airbox. Push it in the oval opening from the inside of the housing until the filter lip locks into place.

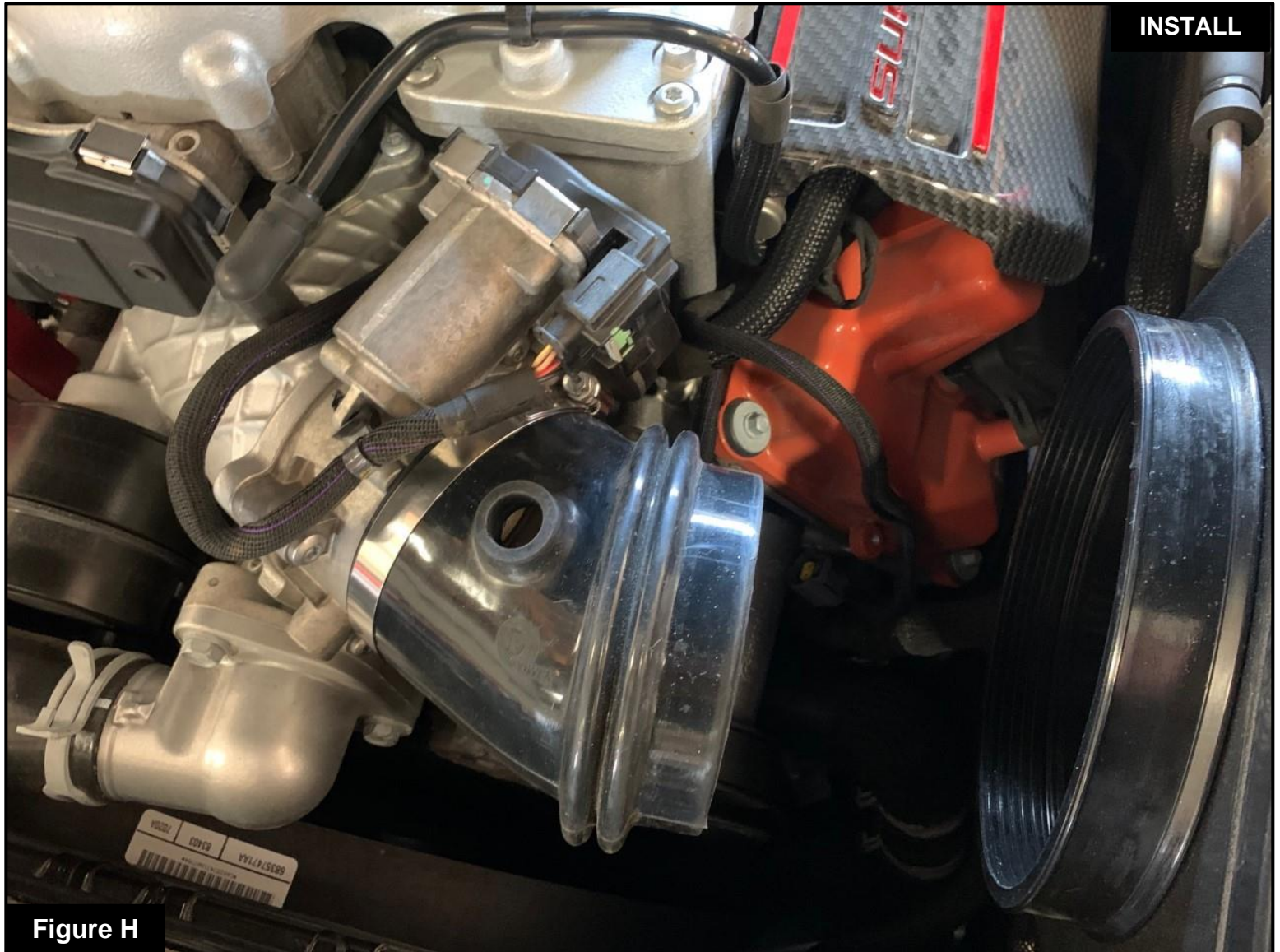

Figure H

Refer to Figure H for Step 14

Step 14: Install the coupling on the throttle body. Install with the clamp closest to the throttle body only. Do not tighten clamp yet.

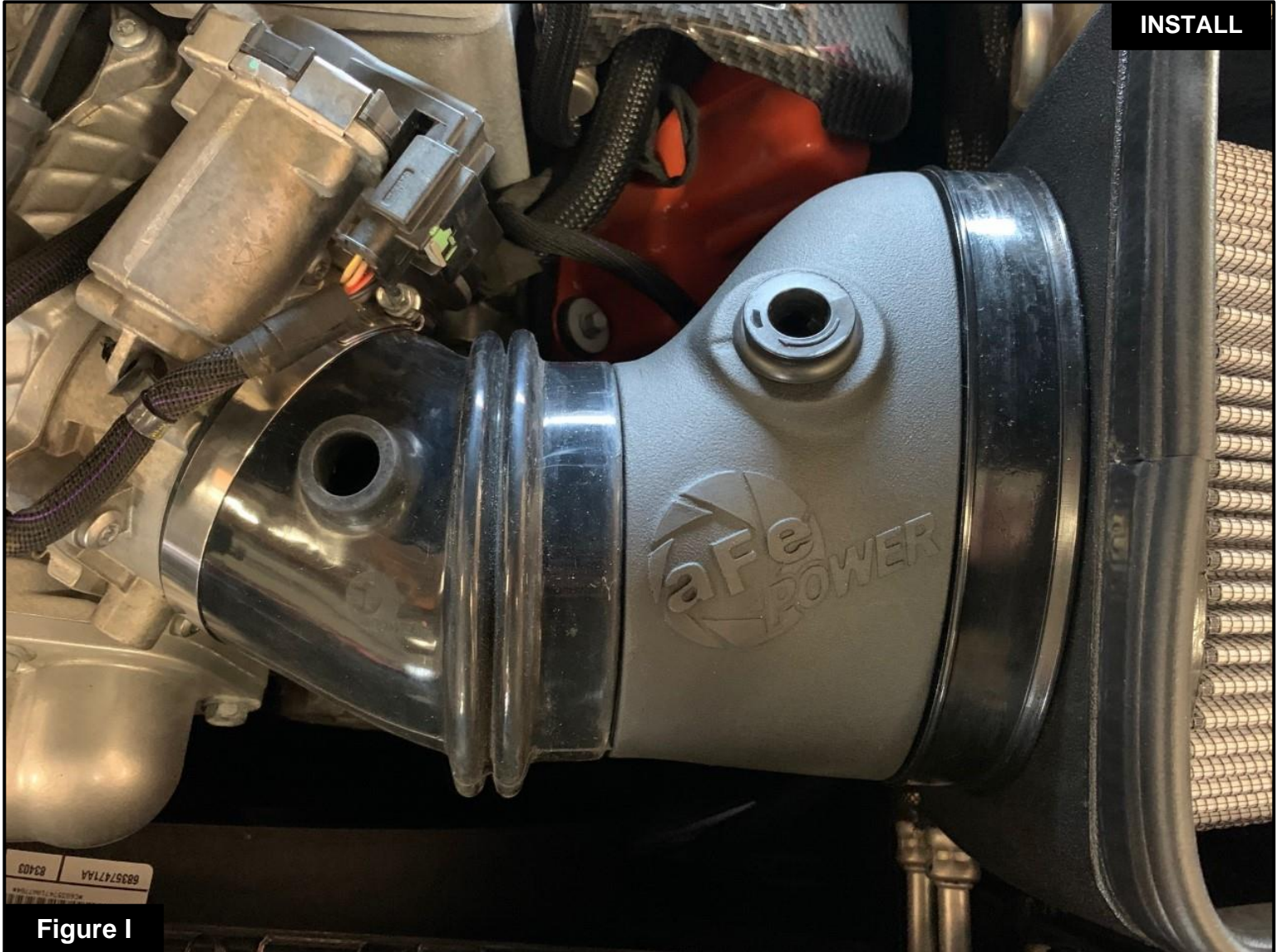

Figure I

Refer to Figure I for Steps 15

Step 15: Install the aFe POWER intake tube by sliding the tube into the filter first and then the coupling.

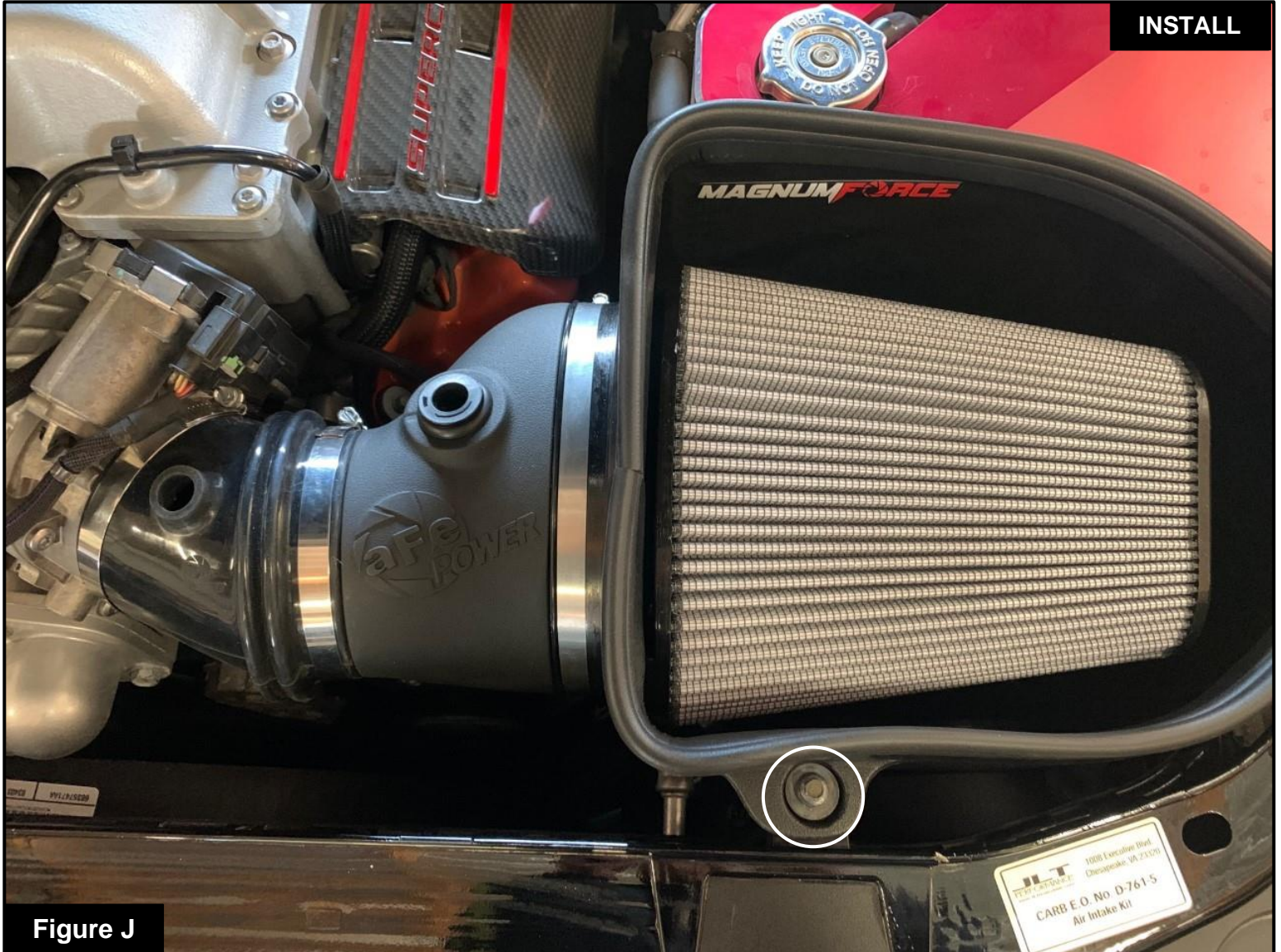

Figure J

Refer to Figure J for Steps 16-18

Step 16: Open the two (2) remaining clamps and install them around the filter and intake tube.

Step 17: Adjust the tube and coupling as needed and then tighten all clamps.

Step 18: Install the 8mm bolt removed in Step 7 to secure the aFe POWER airbox.

**Figure K****Refer to Figure K for Steps 19 (For SRT Demon Only)**

Step 19: **(For SRT Demon only)** Transfer the plastic 90 degree fitting from the factory intake tube to the aFe POWER coupling and connect to the PCV hose.

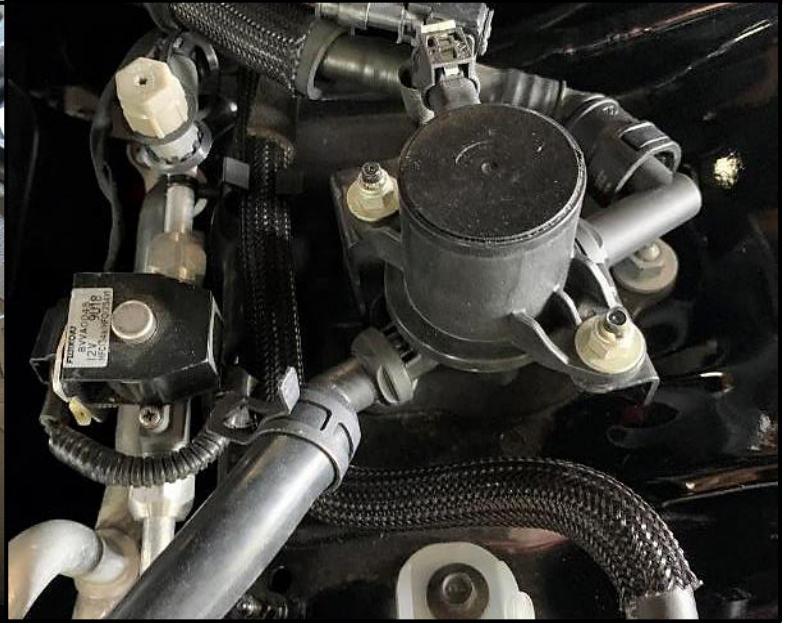
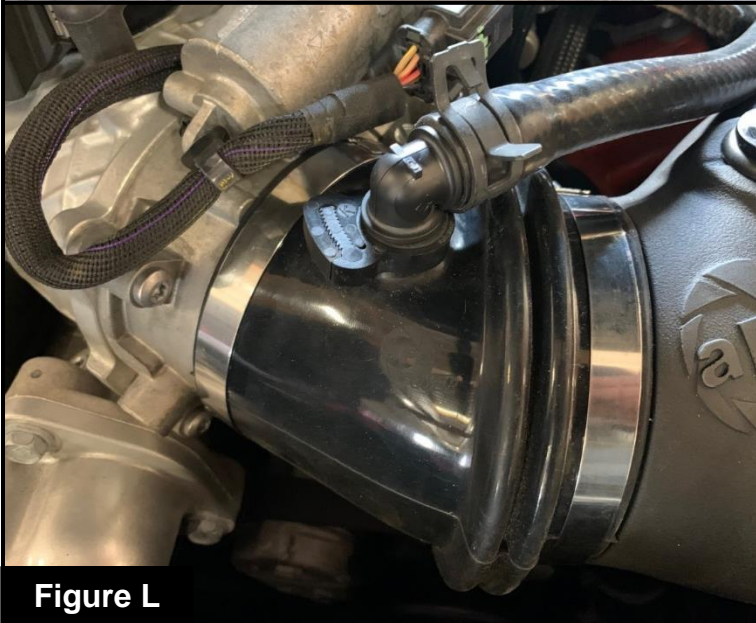
**Figure L****Refer to Figure L for Steps 20-21 (For SRT Hellcat Redeye and Hellcat Only)**

Step 20: (For SRT Hellcat Redeye and Hellcat Only) Install the two spring clamps over the provided silicone hose (deep enough on the hose so you can still install a fitting into the hose). Press the 90 Degree elbow fitting into one end of the hose.

Step 21: (For SRT Hellcat Redeye and Hellcat Only) Place the Snap-Grip Clamp over the hole onto the coupling then press in the 90 Degree elbow fitting into it. Connect the silicone hose to the MUA system. Secure the hose with the spring clamps, and close the Snap-Grip clamp using pliers to secure the 90 Degree fitting into the coupling. Reinstall the MUA cover if it was removed in Step 3.



Figure M

Refer to Figure M for Step 22 (SRT Hellcat Redeye shown)

Step 22: Transfer the temp sensor from the factory intake tube to the aFe POWER intake tube and connect it to the engine harness. Your installation is now complete. Thank you for choosing aFe POWER!

NOTE: Check all screws, clamps, and connectors are secure after 100-200 miles.



Page left blank intentionally



Page left blank intentionally



Page left blank intentionally



advanced FLOW engineering, inc.

252 Granite Street Corona, CA 92879

<https://afepower.com/contact>