

advanced FLOW engineering Air Intake System

Instruction Manual P/N: 55-10014D / 55-10014R

Make: RAM

Model: 1500 TRX

Year: 2021-2023

Engine: V8-6.2L (sc)



- Please read the entire instruction manual before proceeding.
- Ensure all components listed are present.
- For technical support please call 951-493-7185.
- Ensure you have all necessary tools before proceeding.
- Do not attempt to work on your vehicle when the engine is hot.
- Retain factory parts for future use.

Label	Qty.	Description	Part Number
A1	2	Air Filter (Pro 5R) For 55-10014R	30-10401R
A2	2	Air Filter (Pro DRY S) For 55-10014D	30-10401D
B	1	Intake Tube	05-5510014B1
C	1	Grommet, Rubber: MS35489-77	03-50167
D	1	Fitting, Air Temp Sensor	05-01454
E	1	Fitting, 3/8" NPT x 1/2" Barb	03-50794
F	1	Hose, Silicone Breather: 1/2" ID, Black (10" L)	05-01396
G	2	Clamp, 080 (3-1/2" - 5-1/2")	03-50011
H	1	Coupling, Silicone Hump: 5"ID x 3"L	05-01255
J	1	Coupling, Silicone Bellow: (108mmx100mm)ID x 3"L	05-01703
K	1	Clamp, 072 (3" - 5")	03-50010
M	1	Clamp, 064 (3-9/16"- 4-1/2")	03-50006

Installation will require the following tools:

Trim removal tool, 8mm, 10mm, and 13mm sockets, 6" ratchet extension, ratchet, adjustable wrench, razor blade.

Warranty Information available at <https://afepower.com/contact#warranty>

Emissions Disclaimer: This product is not currently CARB exempt and is not available for purchase in California or for use on any vehicle registered with the California Department of Motor Vehicles.

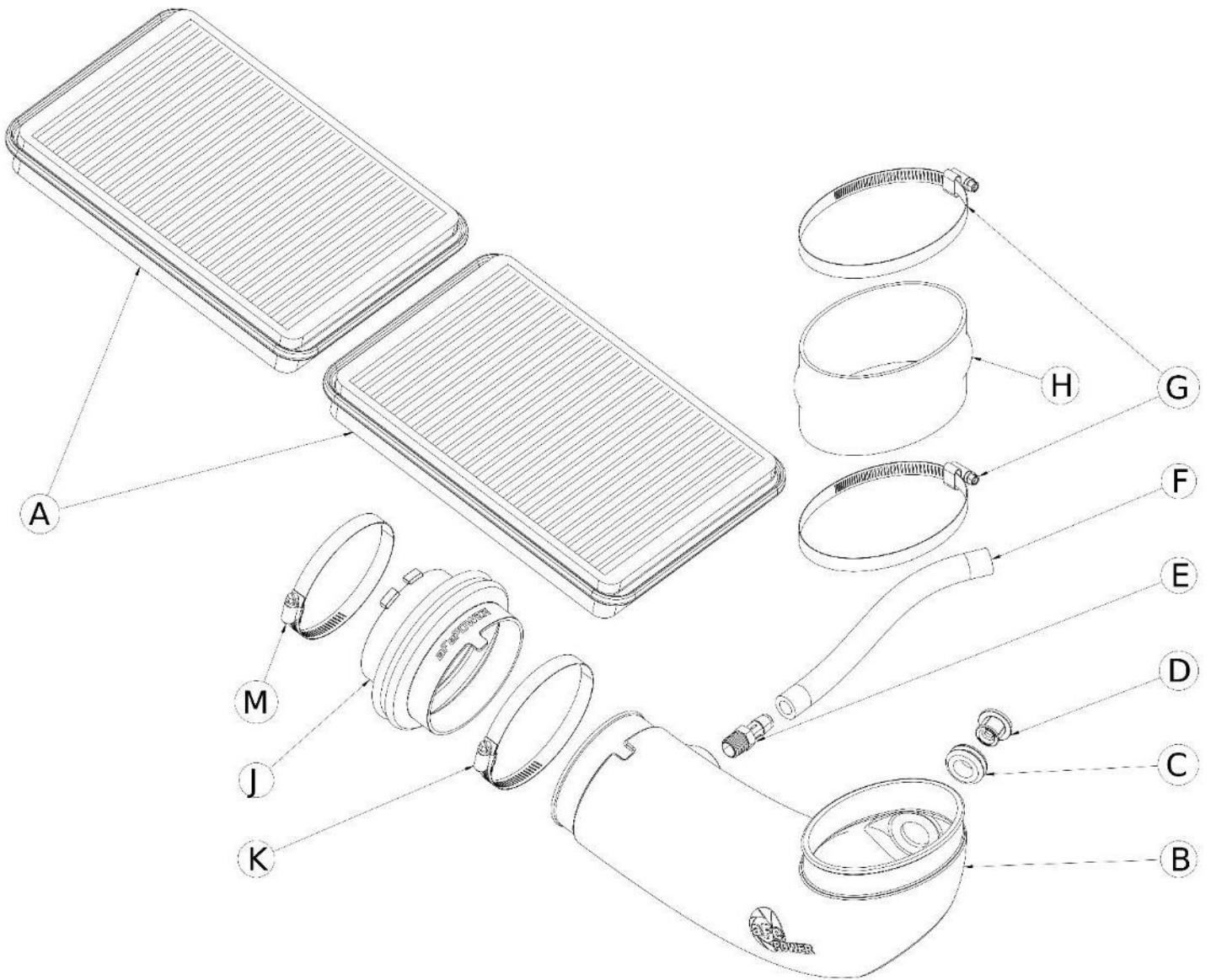

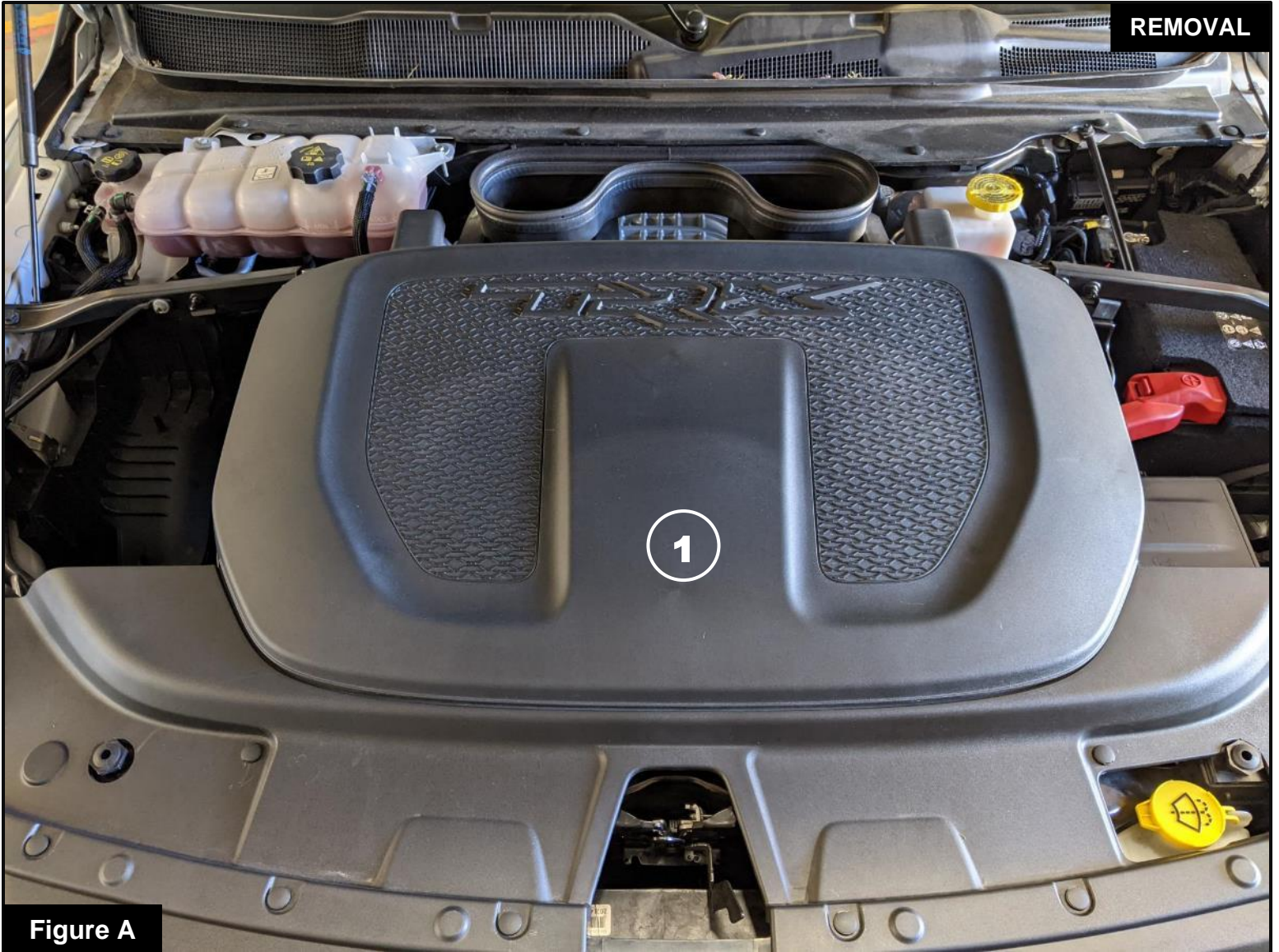

Figure A

Refer to Figure A for Step 1

Step 1: Remove the factory air intake cover ①.

**Figure B****Refer to Figure B for Step 2**

Step 2: Using a small trim removal tool, remove the sixteen (16) clips ② securing the factory front cowl, then remove the cowl.

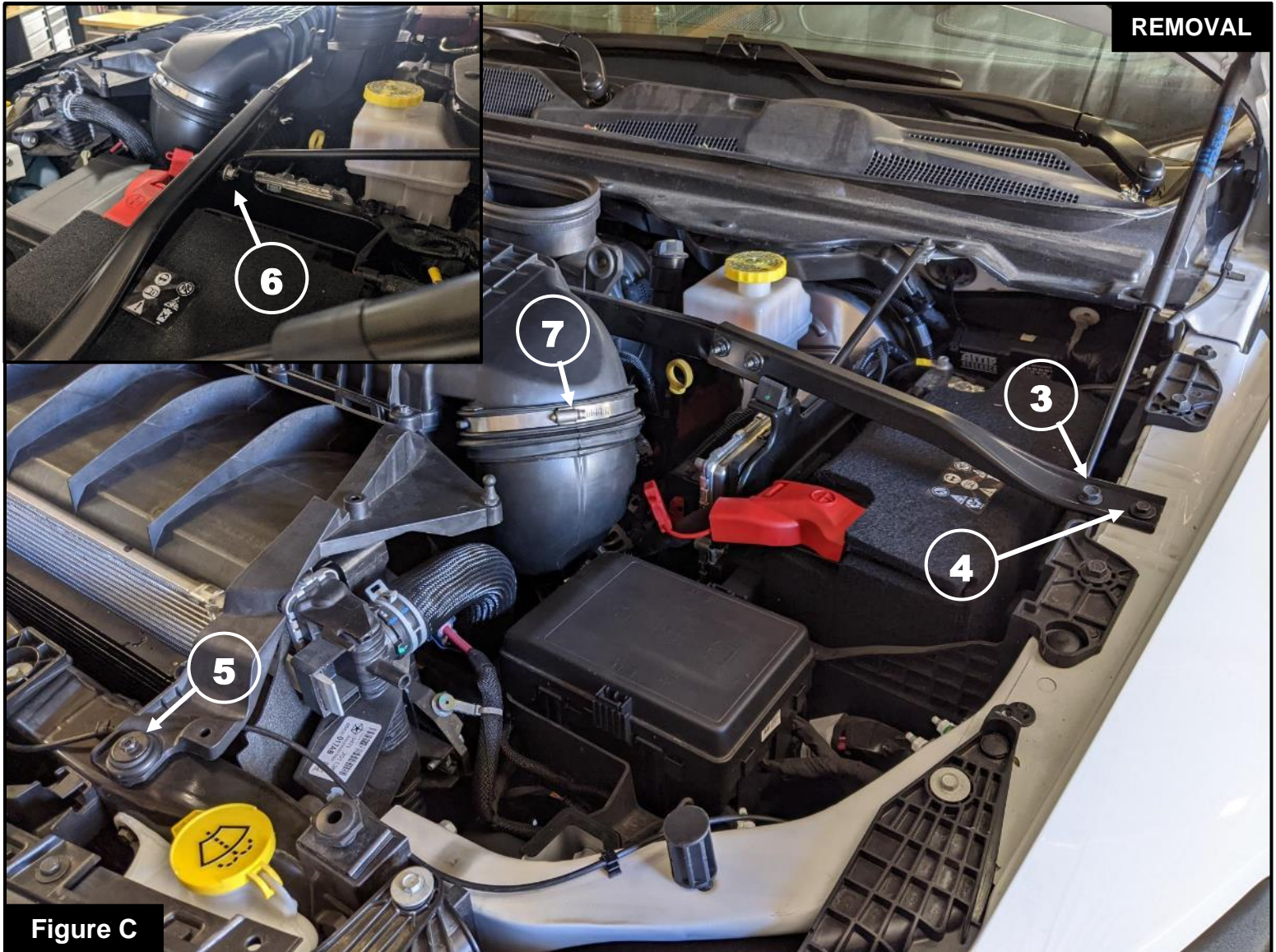

Refer to Figure C for Steps 3-5

Step 3: On the driver side of the vehicle, use a 13mm socket and driver to remove the larger screw (3) securing the factory intake brace.

Step 4: Using a 10mm socket and driver, remove the smaller screw securing the factory intake brace (4) as well as the screw (5) securing the factory intake to the core support in the front of the vehicle. Remove the single nut (6) on the back side of the intake brace using a 10mm socket and driver.

Step 5: Using an 8mm socket and driver, loosen the clamp (7) at the factory air intake tube.

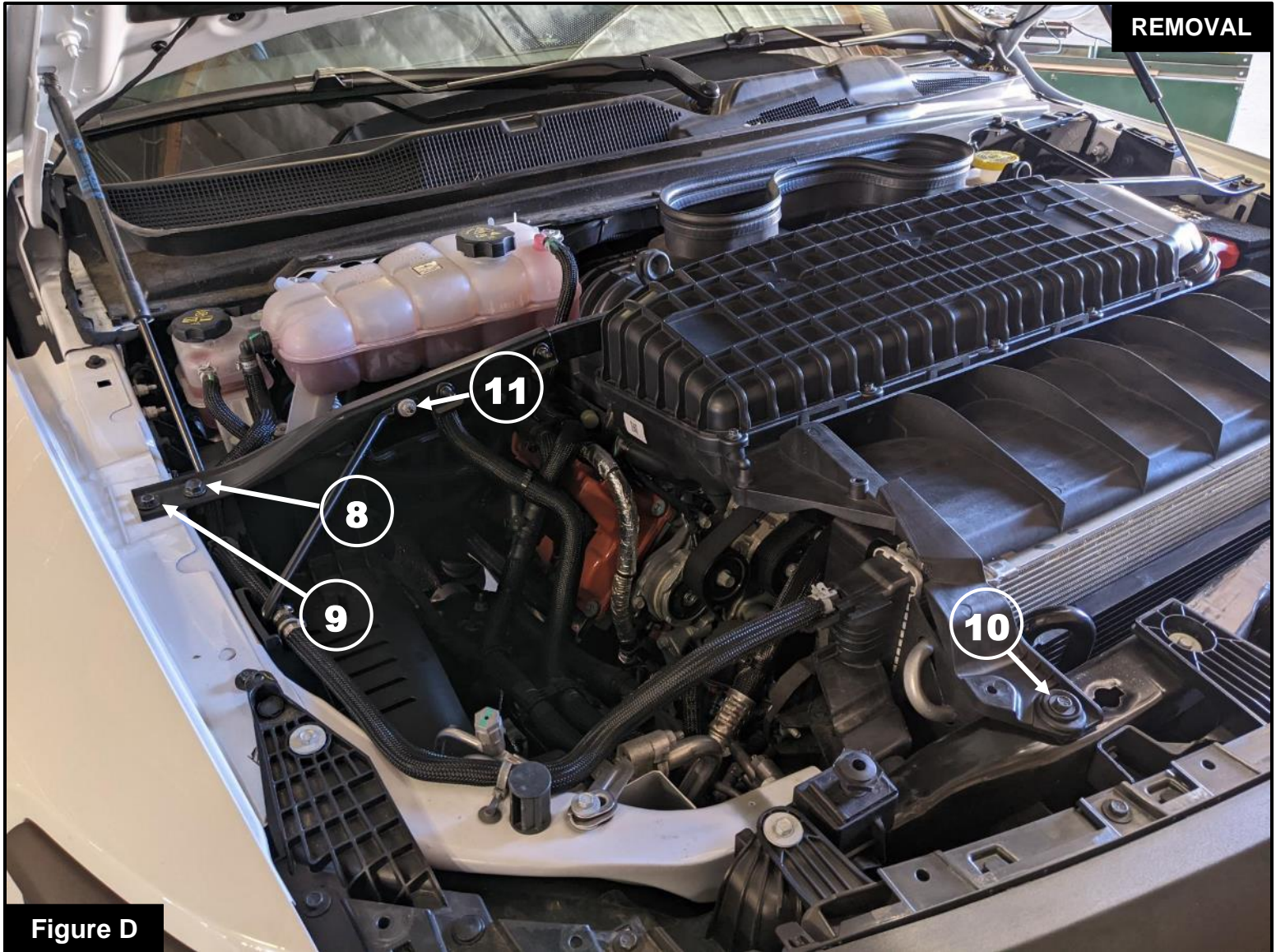

Figure D

Refer to Figure D for Steps 6-8

Step 6: On the passenger side of the vehicle, use a 13mm socket and driver to remove the larger screw (8) securing the factory intake brace.

Step 7: Using a 10mm socket and driver, remove the smaller screw securing the factory intake brace (9) as well as the screw (10) securing the factory intake to the core support in the front of the vehicle. Remove the single nut (11) on the front side of the intake brace using a 10mm socket and driver.

Step 8: Carefully lift the factory air intake out of the vehicle leaving the intake tube in the vehicle.

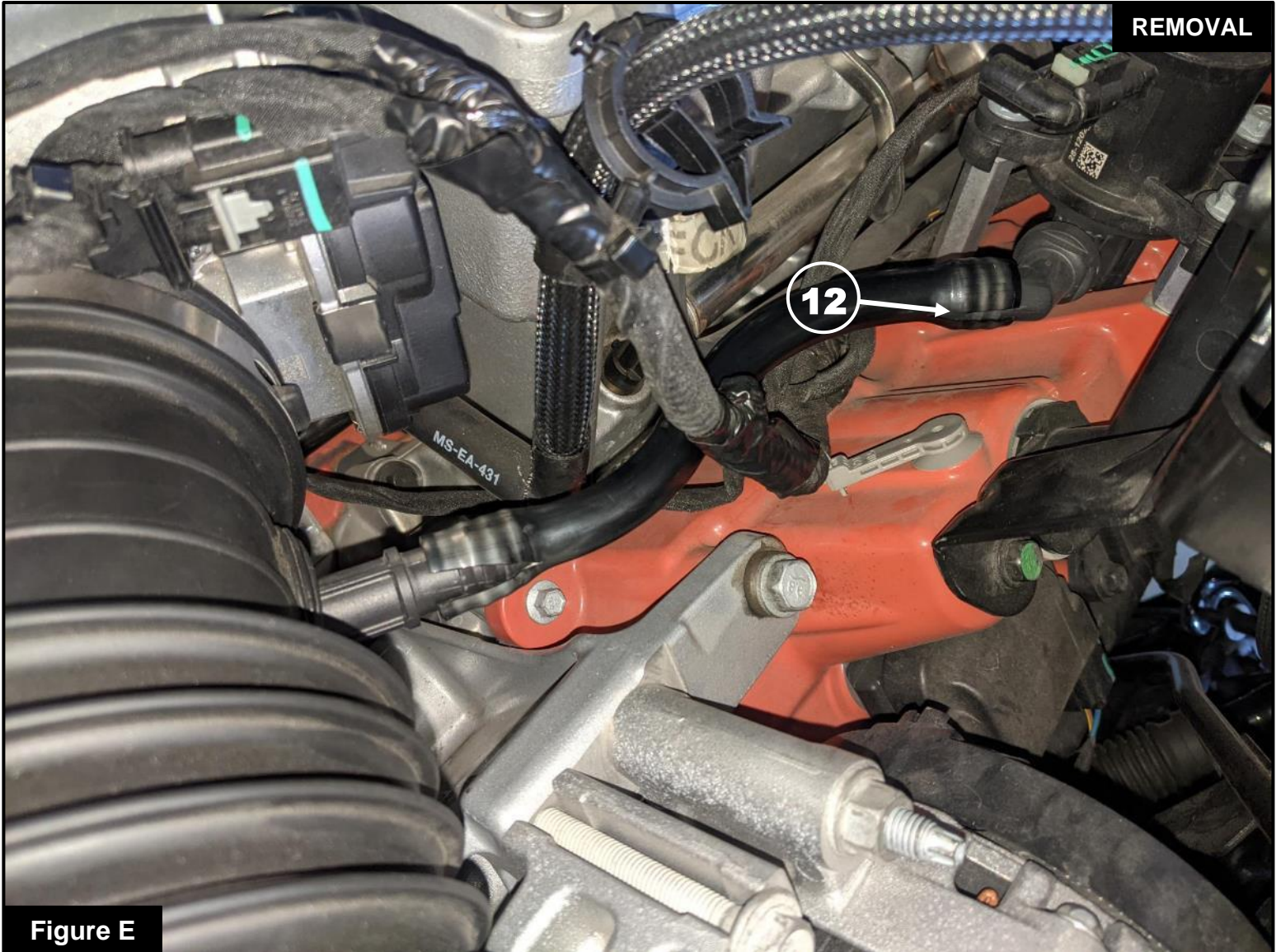
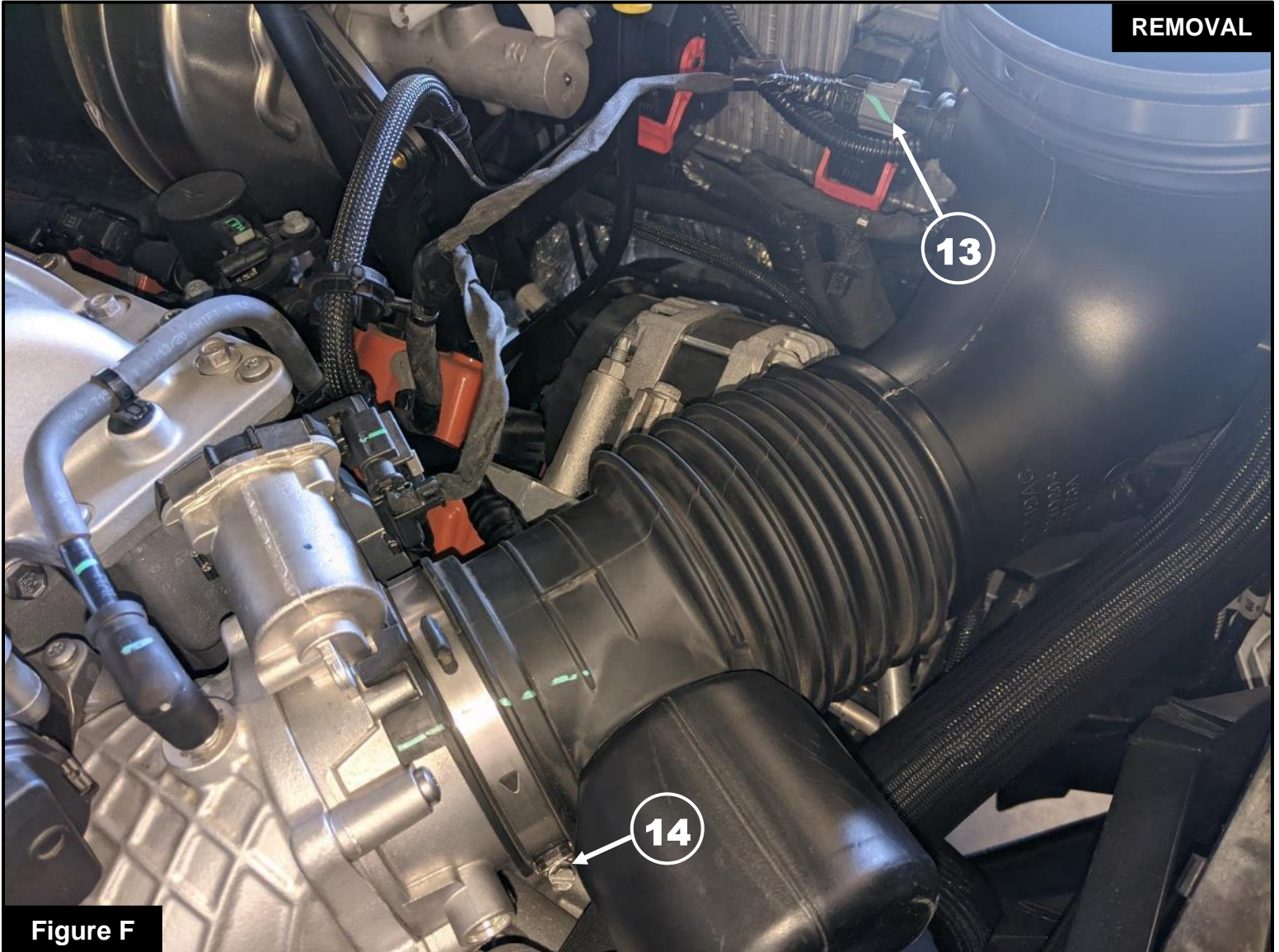

Figure E

Refer to Figure E for Step 9

Step 9: Using a razor blade, carefully cut the plastic line ⑫ connected to the MUA system on the valve cover. If you ever need to reinstall the factory intake, we recommend using heat-shrink to cover the cut.

**Figure F****Refer to Figure F for Steps 10-11**

Step 10: Disconnect the IAT sensor wire harness (13) .

Step 11: Using an 8mm socket and driver, loosen the clamp at the throttle body (14) then remove the factory air intake tube.

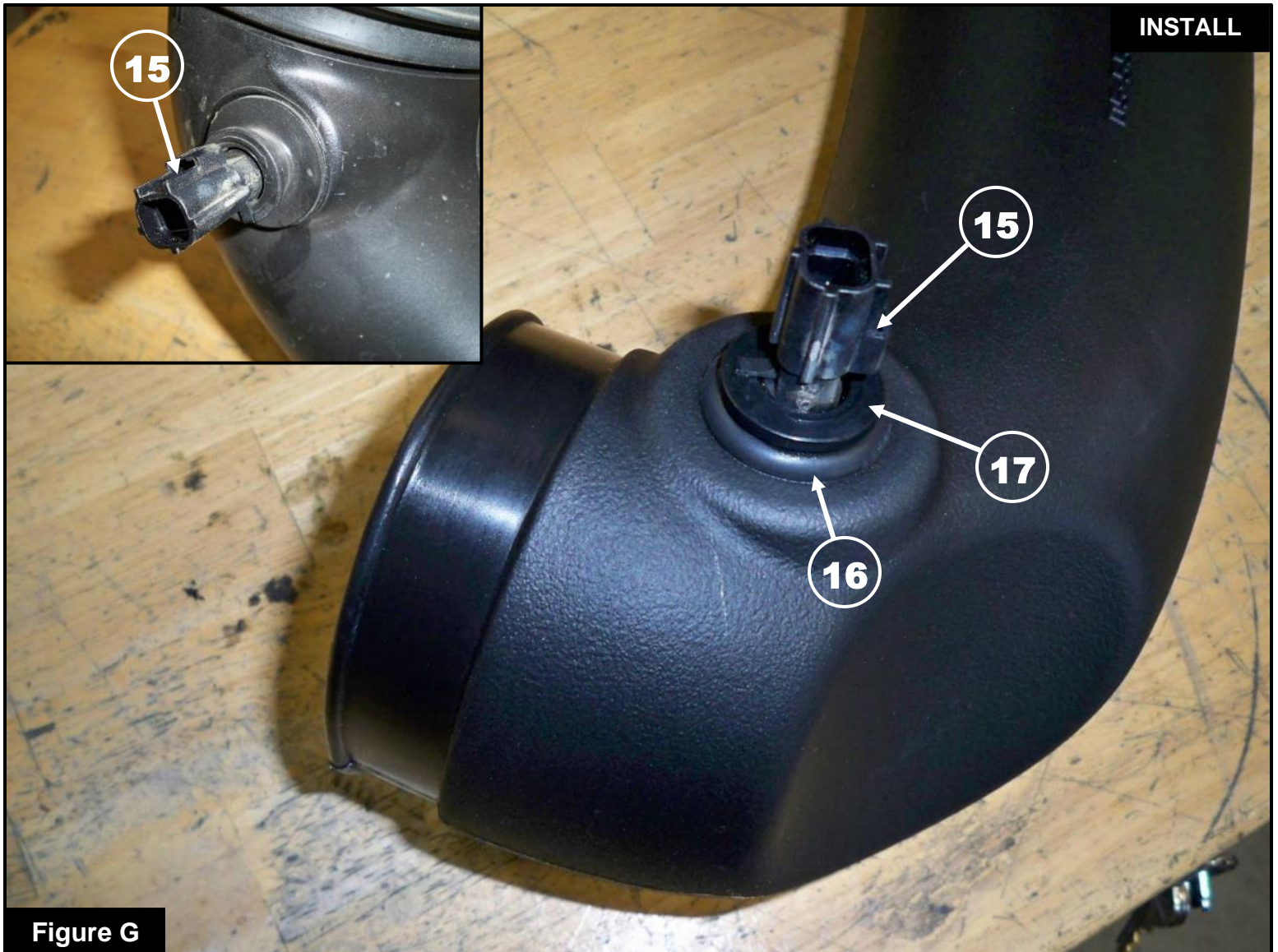

Figure G

Refer to Figure G for Steps 12-14

Step 12: Remove the IAT sensor (15) from the factory intake tube by rotating ¼ turn counterclockwise and gently pulling it out.

Step 13: Install the provided grommet (16) and temp sensor fitting (17) into the the aFe POWER intake tube.

Note: Lubricant can be used to facilitate the installion of the fitting into the grommet.

Step 14: Install the IAT sensor into the temp sensor fitting by rotating ¼ turn clockwise until it locks into place.

**Figure H****Refer to Figure H for Steps 15-16**

Step 15: Using an adjustable wrench, install the supplied vent fitting (18) into the aFe POWER intake tube. Do not overtighten, some threads will still be exposed.

Step 16: Install the supplied hump silicone coupling (19) with the two (2) supplied #80 clamps (20) onto the oval end of your aFe POWER intake tube. Leave both clamps loose.

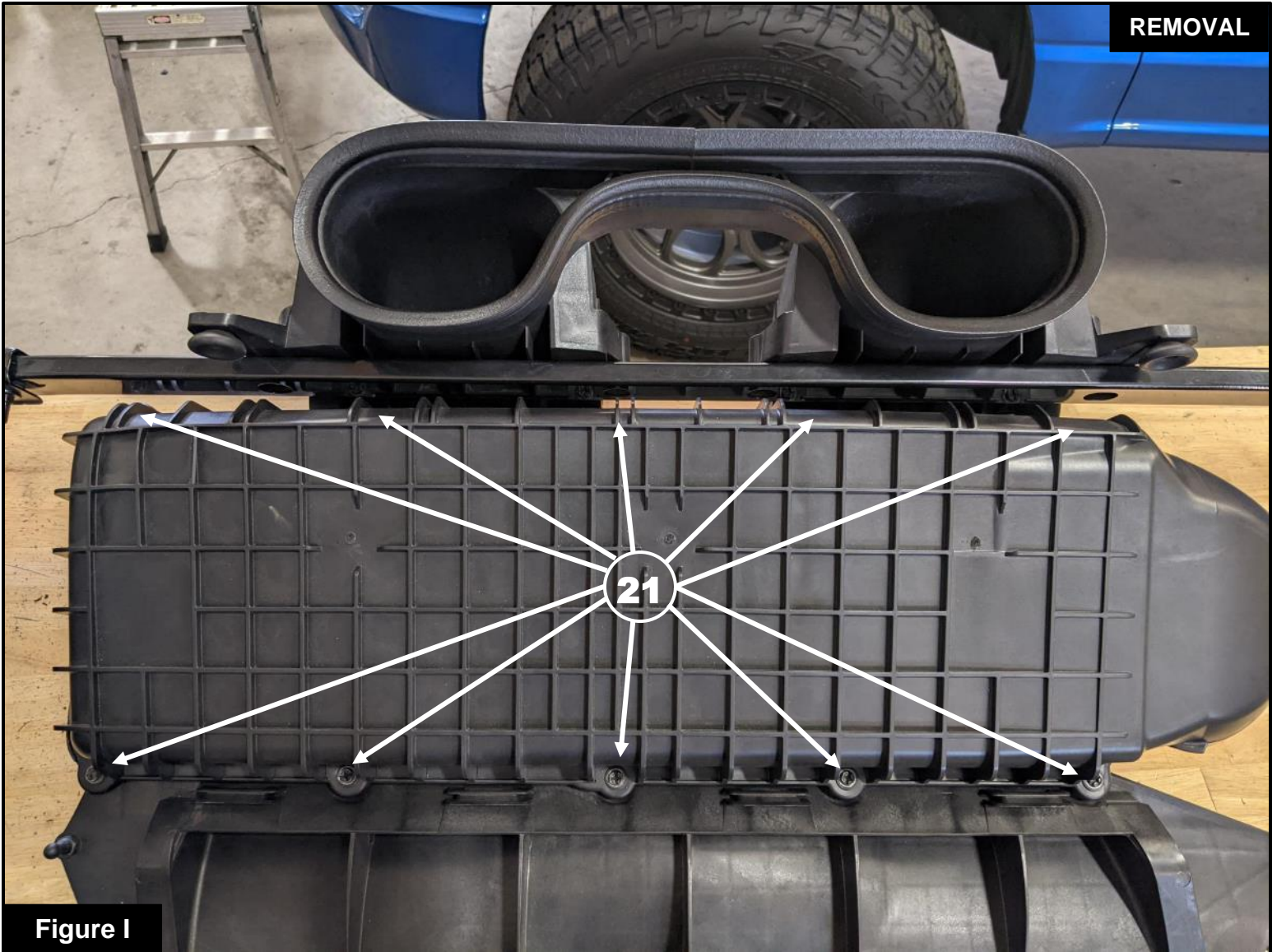
**Figure I****Refer to Figure I for Step 17**

Step 17: Using an 8mm socket and driver with an extension, loosen the ten (10) screws ②① sealing the factory filter housing and remove the lid.

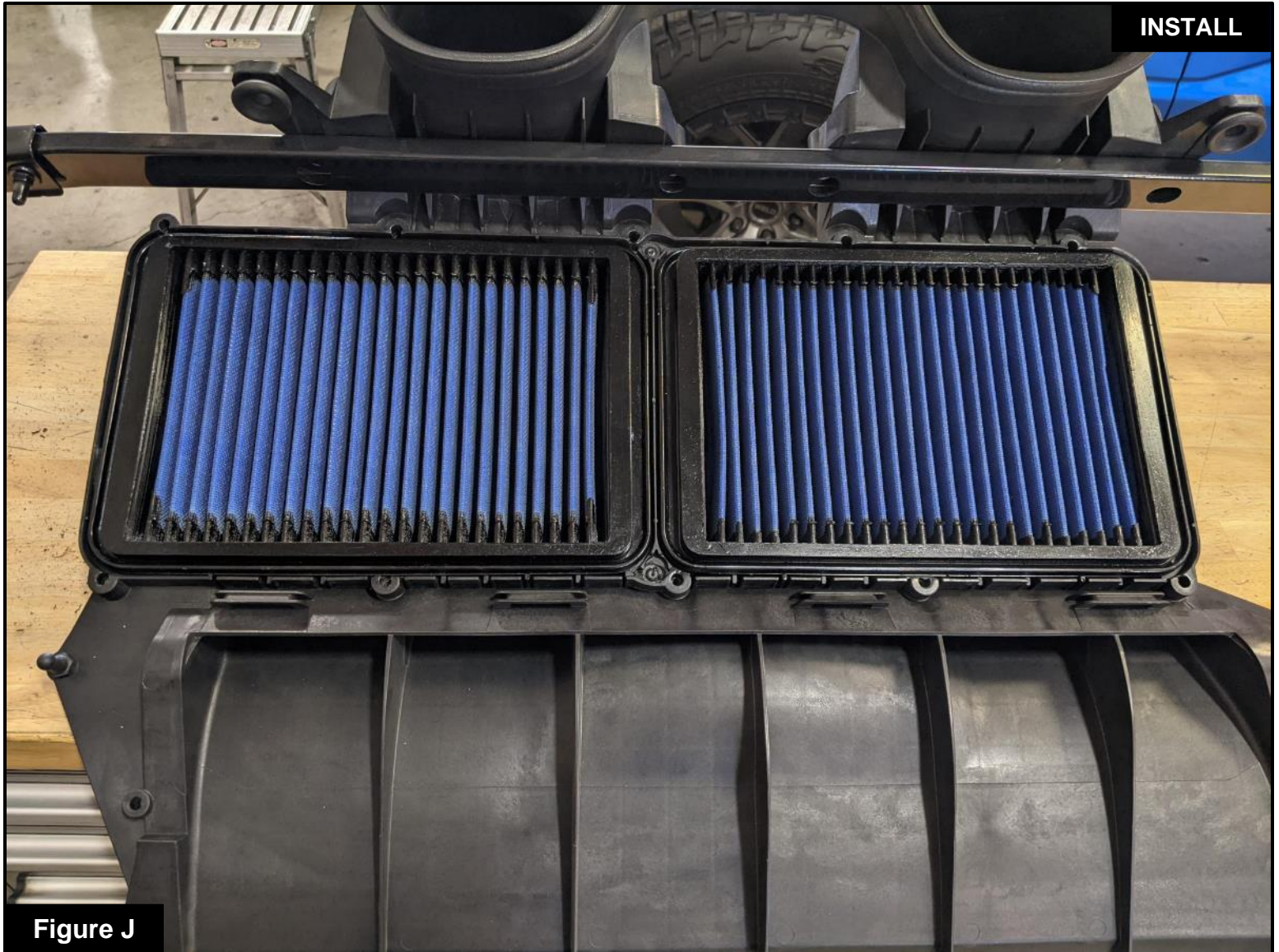

INSTALL

Figure J

Refer to Figure J for Step 18

Step 18: Remove the factory air filters and replace with your aFe POWER flat panel air filters, then replace the factory filter housing lid and tighten the ten (10) screws using an 8mm socket and driver with an extension.

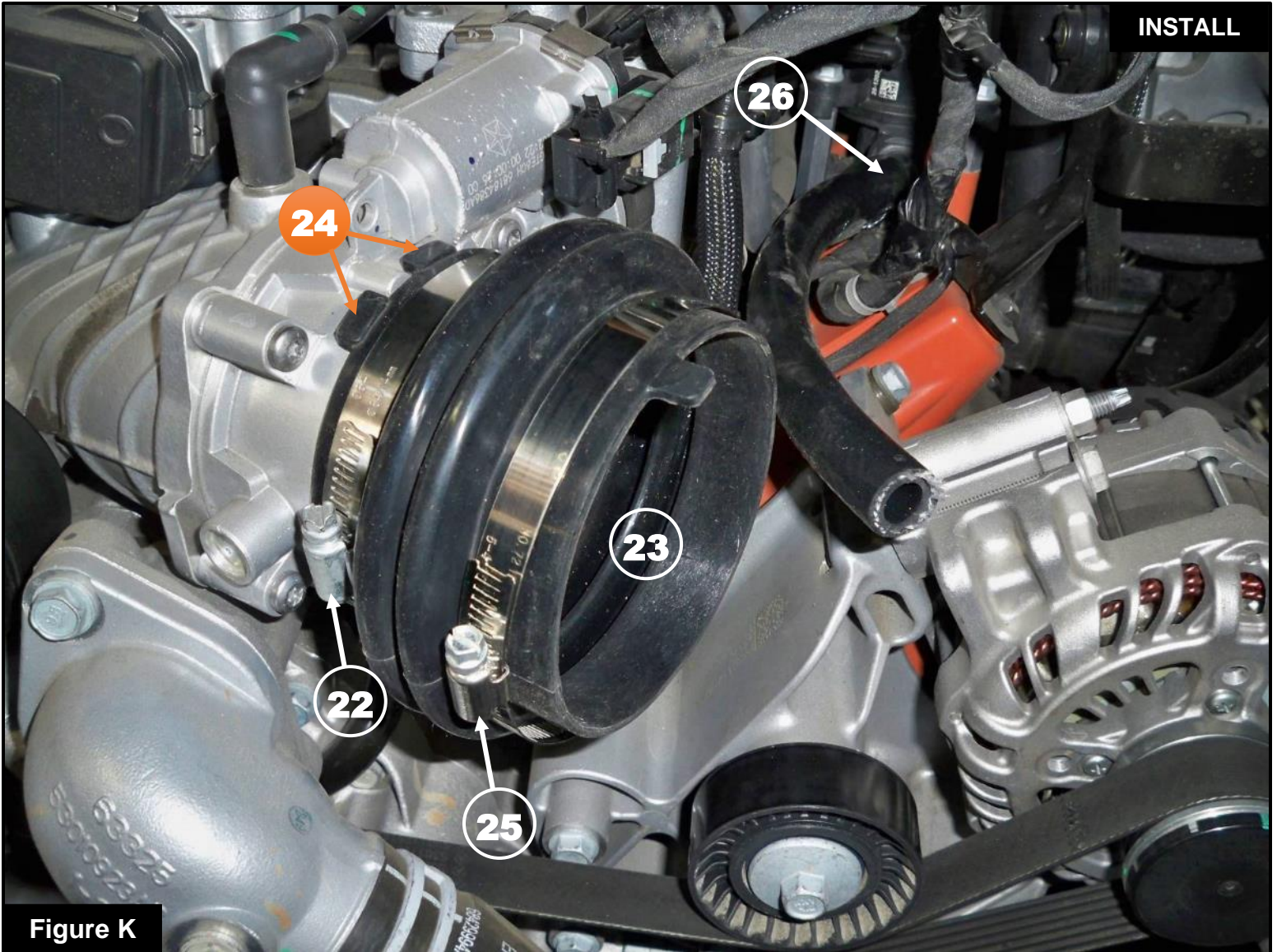
Figure K

Refer to Figure K for Steps 19-21

Step 19: Install the supplied #64 (22) clamp and bellow coupling (23), with the smaller side on the throttle body. Make sure the indexing tabs (24) are straddling the index on the throttle body as shown. Once aligned, secure the clamp using an 8mm socket and driver.

Step 20: Place the supplied #72 clamp (25) onto the open end of the bellow coupling.

Step 21: Install the supplied length of hose (26) onto the MUA system as shown.



Figure L

Refer to Figure L for Steps 22-24

Step 22: Install your aFe POWER intake tube into the bellow coupling at the throttle body making sure to align the index tab (27) on the coupling with the index on the tube as shown. Secure the clamp using an 8mm socket and driver.

Step 23: Connect the IAT sensor electrical connector (28).

Step 24: Connect the hose (29) to the vent fitting on your aFe POWER intake tube. Cut the hose to the desired length for perfect fitment.

**Figure M****Refer to Figure M for Steps 25-26**

Step 25: Re-install the factory filter housing assembly by following steps 3-7 in reverse order. While installing the system, make sure the filter housing outlet slips into the hump silicone coupling on your aFe POWER intake tube. Use a trim removal tool to assist if necessary.

Step 26: Once fully seated against the tabs on the filter housing outlet, use an 8mm deep socket and ratchet to tighten both clamps.

**Figure N****Refer to Figure N for Steps 27-28**

Step 27: Re-install the front cowl using the sixteen (16) clips removed in step 2.

Step 28: Re-install the factory air intake cover. Your Installation is now complete. Thank you for choosing aFe POWER!

NOTE: Check all screws, clamps, and connectors are secure after 100-200 miles



PAGE LEFT BLANK INTENTIONALLY



PAGE LEFT BLANK INTENTIONALLY



advanced FLOW engineering, inc.

Corona, CA 92879

<https://afepower.com/contact>