

MAGNUSON

SUPERCHARGERS

Installation Instructions for:
2012-2018 TVS1900 Jeep JK
INTERCOOLED SUPERCHARGER SYSTEM



*** PREMIUM 91 OCTANE GASOLINE FUEL REQUIRED ***



ATTENTION!
Your **MAGNUSON SUPERCHARGER** kit
is sensitive to corrosion!
Use **only the vehicle manufacturer**
recommended coolant for your engine in
the intercooler system as well.

89-89-61-035 Rev.M

Magnuson Superchargers
1990 Knoll Drive, Bldg A, Ventura, CA 93003
(805) 642-8833 phone
magnusonsuperchargers.com

INSTALLATION MANUAL

Magnuson Supercharger Kit: TVS1900 2012-2018 Jeep JK

Please take a few moments to review this manual thoroughly before you begin work: Make a quick parts check to be certain your kit is complete (see Bill of Material (BOM) parts list inside the accessory box). If you discover shipping damage or shortage, please call our office immediately. Take a look at exactly what you are going to need in terms of tools, time, and experience. Review our limited warranty with care.

Use only premium gasoline fuel, 91 octane or better. The use of non-premium fuel can cause engine failure and will void your warranty.

Magnuson Products recommend that you run a minimum of one tank of premium 91 octane or better fuel through your vehicle prior to installation of the system to prevent any possible damage that may occur due to running the supercharged engine on lower octane fuel.

DO NOT RUN E85 FUEL WITH THE SUPERCHARGER.

DO NOT USE OCTANE BOOSTERS. If you have used octane boosters in the past you will have to replace your spark plugs and the O2 sensors.

Magnuson Superchargers systems are designed for engines and vehicles in "GOOD" mechanical condition. Magnuson Superchargers recommend that a basic engine system "Health Check" be performed prior to the installation of this supercharger system. Be sure to check for any pending or actual OBDII codes and fix/repair any of the stock systems/components causing these codes. If there are codes prior to the installation they will be there after the installation.

Magnuson Superchargers also recommend the following services to be performed on your vehicle while installing the supercharger system:

- Fuel Filter, and Air Filter change
- Engine oil and filter change using brand name oil (organic or synthetic) and filter

NOTE: 2012-2013 Model year kits have less clearance to remove the oil filter and therefore the cap must be removed separately from the filter to properly service them.

Note: It is VERY IMPORTANT to use the factory specified oil viscosity. The original equipment manufacturer has selected this grade of oil to work with your other engine systems such as hydraulic chain tensioner and variable cam controls. Deviation from this specification may cause these systems to fail or not function properly. Please refer to your owner's manual for the recommended oil viscosity or your engine and application.

- **This kit includes the recommended NGK one step colder than stock spark plugs: NGK #6706 (0.035 air gap)**
- **If / when replacing the plugs on this supercharged vehicle in the future, replace with: NGK #6706 (0.035 air gap)**

On older vehicles Magnuson Superchargers recommend these additional services to be performed:

- Coolant system pressure test and flush.

NOTE: YOU MUST USE JEEP SPECIFIED COOLANT MIXTURE!

- 2012-2013 Vehicles that have an OEM Hood with a single windshield squirter will have to upfit to a later model year 2017-2018 Jeep squirter to allow proper clearances when the hood is closed.

Non "Magnuson Superchargers Approved" calibrations or "tuning" will Void ALL warranties and CARB certification. Our supplied calibration is designed for use with the components provided in this kit. Any adjustment to the intake, or exhaust systems or other engine components may adversely affect engine performance and may trigger your check engine light.

Tools Required:

Safety glasses

Metric wrench set

1/4" - 3/8" and 1/2" drive metric socket set (Standard & Deep)

3/8" and 1/2" drive foot pound and inch pound torque wrenches

Phillips and flat head screwdrivers

Hose cutters, Tree clip removal tool

Hose clamp pliers, Telescoping magnet

Metric Allen socket set 3/8" drive

Shop vacuum cleaner

Blue Loctite 242

T30 Torx socket

Contact Information:

Magnuson Superchargers

1990 Knoll Drive, Bldg A

Ventura, CA 93003

Sales/Technical Support Line (805) 642-8833

Websites www.magnusonsuperchargers.com

Email sales@magnusonsuperchargers.com

ATTENTION

Prior to installing this supercharger kit, there are several things to be aware of regarding how your Jeep JK calculates transmission shift points, and procedures to follow to ensure that your Jeep shifts correctly.

The Jeep JK engine controller (ECU) uses the vehicle wheel speed to calculate transmission shift points and tell the Transmission Control Module (TCM) when to shift. There is currently no aftermarket programmer or controller that allows access to the Jeep JK TCM. If you have changed your wheel and tire sizes, you must do the following:

- If you have installed larger wheels and tires, we highly recommend you also install new gearing to maintain the factory drive ratio. If you increase tire size, you will need a lower gear (numerically higher). There are several calculators and charts available online that can guide you in choosing the correct gear ratio for your tire size
- If you have used an aftermarket programmer, such as an AEV ProCal, a Diablo tuner, or Superchips, to adjust for your larger tire size prior to installing your supercharger, you must set your calibration back to stock before applying the supplied Magnuson tune. You can then either adjust the wheel and tire size using an AEV Procal device. If you apply the tire-size adjustment without first removing the previous tune, it will stack the tire calibration. The vehicle will think it will have much larger tires than it does, and the transmission shift points will be incorrect. If in doubt, contact the shop that installed the wheels and tires, and find out how they calibrated the ECU for the larger tires

Also be aware that the Jeep JK transmission has a tendency to hang onto gears, especially under load. Larger wheels and tires, adding weight such as vehicle accessories or heavier bumpers, driving up grades, towing a trailer, or driving at wide-open throttle may cause the transmission to hang in gear and take longer to shift than you would expect. There is currently no fix for this, or any modifications we can make to the ECU to correct this. There are a few workarounds, however, such as using the manual shift mode, or lifting off the throttle slightly.

NOTES: For the purpose of these instructions, all references to left hand side or right hand side shall be interpreted as if being seated in the driver seat of the vehicle.



1. Prior to beginning the installation of your supercharger system we recommend that you schedule your vehicle at the dealership to have the most recent stock calibration loaded. This **MUST** be done before proceeding any further.

2. Open up the supplied programmer package and follow the instructions for programming the vehicle prior to disconnecting the battery and beginning the installation of the supercharger system. This **MUST** be done before proceeding any further to insure that you have all the benefits of the latest level of updated software from the manufacturer. The handheld tuner may not look like the one shown.



3. Your supercharger system is sensitive to corrosion. Use only the OEM recommended coolant mixture for your supercharger system as well as your engine.



4. It is **IMPORTANT** to utilize 91 Octane gasoline or better with your supercharger system. Before starting this installation, on an empty tank, fill your tank to full with 91 Octane gasoline or better. Never add Octane booster to your fuel. If you have used Octane Booster in the past, replace your spark plugs and your O2 sensors before completing your supercharger install.

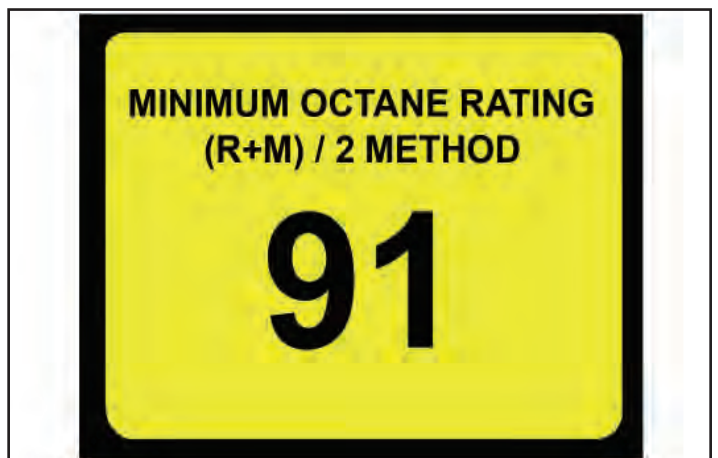

5. Disconnect the windshield washer tube from its connector on the left side of the firewall

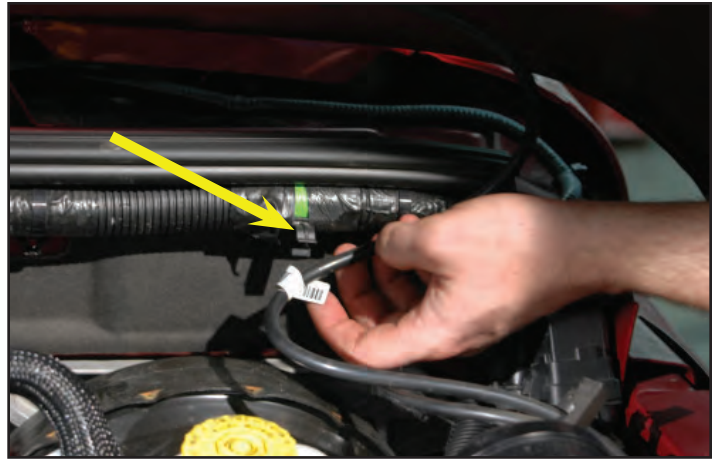

6. We found it easiest to install the supercharger with the hood resting against the roof. Carefully lift the hood back against the top of the window frame using a soft blanket or towel as a buffer between the hood and the roof as shown.



7. If you have a stock hood, the hood insulator will need to be removed to prevent the Supercharger from sucking it into the airbox. (which will prevent full boost from being generated)



8. Remove the pushpins (shown below) that retain the hood insulator and carefully remove it from the vehicle.



9. IF you have an early model JK Jeep with the single windshield squirter, it will have to be replaced with one from a later model JK (for example 2017) that has a 90-degree lower profile barb on the squirter instead of the straight one. The stock one will not clear the supercharger assembly.



10. Remove the gas cap to relieve gas tank pressure.



11. Locate the fuse box in the engine bay.



12. Remove the # 37 - 10A fuse labeled "ABS, Fuel Pump Relay, Sway Bar" using the fuse removal tool in the fuse box.



13. Start your vehicle to bleed off any residual pressure in your fuel line, run the vehicle until it dies, then try to start a couple more times just to be sure there is no more pressure in the fuel line.



14. Remove the negative battery terminal using a 10mm wrench. Slide the battery cable out of the way and apply some insulation material like tape to it so that it cannot make accidental contact with the battery terminal.



15. **For 2015-2018 Jeep JK only. If you are not providing your own calibration you will need to send in your PCM for unlock. There is a box provided for sending in your PCM with instructions included.** Release the two PCM locks at the yellow arrow locations. Then unplug the connections. Remove the two bolts holding the PCM in the red arrow locations.

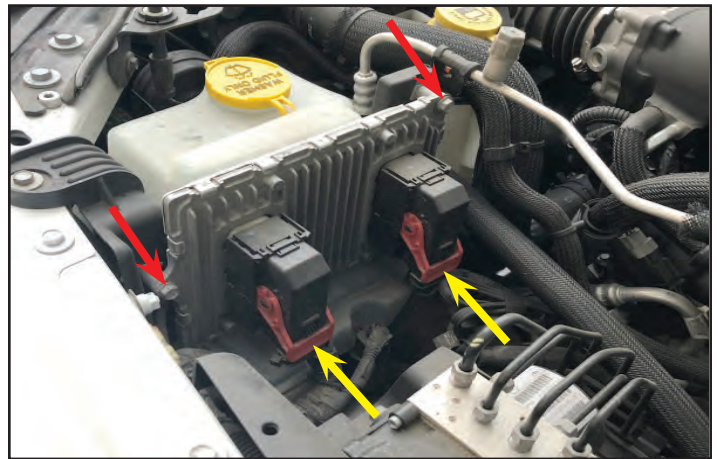

16. Pull up on the engine cover to remove from the vehicle. This will not be reused but you may want to have these parts available to return to factory condition.



17. Use a tree clip removal tool to remove the two tree connectors that hold the manifold insulation to the back of the upper intake manifold.

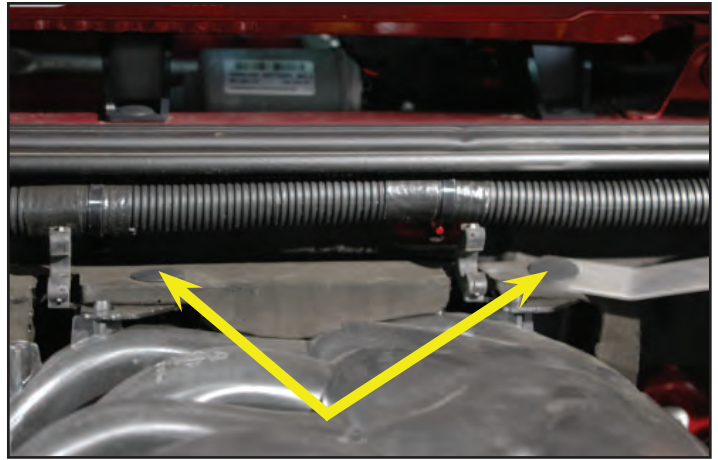

18. Use a 10mm wrench to remove the two plastic fasteners and brackets below the manifold insulation at the back of the upper intake manifold. Remove these brackets.



19. Pull the insulation away from the manifold.



20. Pull the radiator overflow hose from the clamps at the front of the air intake tube. Use a 10mm socket to remove the two air box mounting fasteners.



21. Use an 8mm socket to loosen the throttle body mounting clamp at the air tube to throttle body connection.



22. Use an 8mm socket to loosen the air tube mounting clamp at the air box.



23. Disconnect the IAT electrical connection. Carefully pull the air tube off the throttle body and air box. The OEM IAT Sensor will be replaced in the next step with one supplied in the kit (shown below).

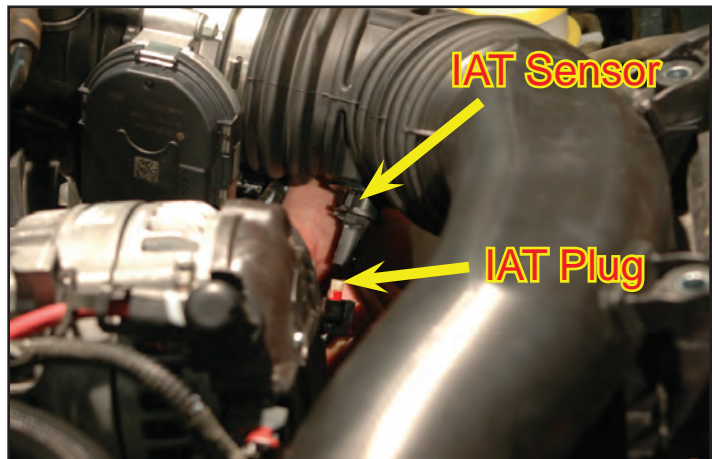
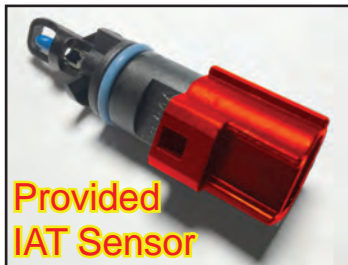

24. Remove the OEM sensor (shown to the right) and replace with the one supplied in the kit (shown in the last step). **The supplied IAT sensor is being used as a plug and will not be connected to your vehicle's electrical system. Cap the electrical connection on the end of the IAT sensor (highlighted in red) with electrical tape to prevent future connection. NOTE: The OEM sensor will be reused in the supplied Upper Intake Manifold in a later step.** Set aside the airtube assembly for later reinstall.



25. Pull the vacuum hose from the side wall hose barb on the air box.



26. Pull up on the air box to remove the assembly from the vehicle. Set aside for later reinstall.



27. Disconnect the harness clip from the tab/boss on the throttle body. Pull out on the red throttle body control locking pin, and then press down on the exposed end to release the plug from the throttle body.

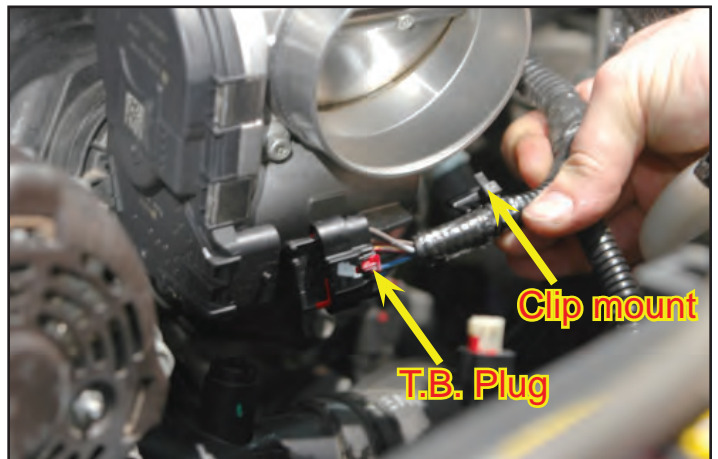

28. Use an 8mm socket to remove the four throttle body mounting bolts. Carefully wipe the throttle body clean and store in a safe place for reinstallation later during the supercharger install.



29. Use a tree clip removal tool to remove the tree connector holding the wire harness to the left side-upper intake manifold connector near the throttle body mounting location.



30. Disconnect the Manifold Absolute Pressure (MAP) sensor from the left side upper intake manifold, near the throttle body mounting location by pressing the release tab and pulling free.



31. Remove the harness mounting "tree" clip from the forward, upper intake manifold mounting bracket.

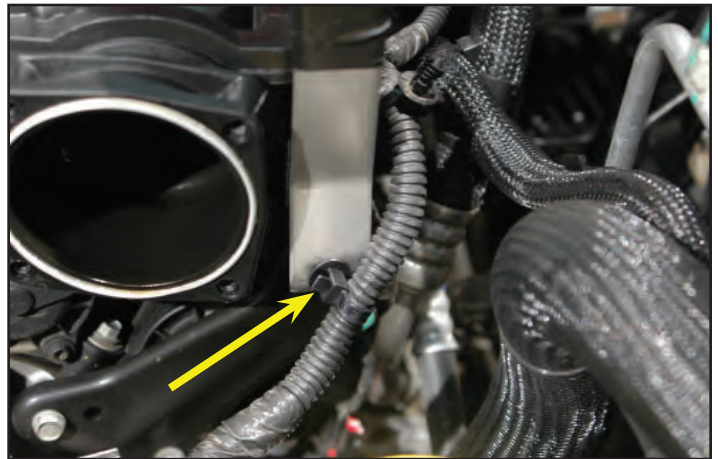

32. Remove the harness mounting "tree" clip from the back of the upper intake manifold mounting bracket.

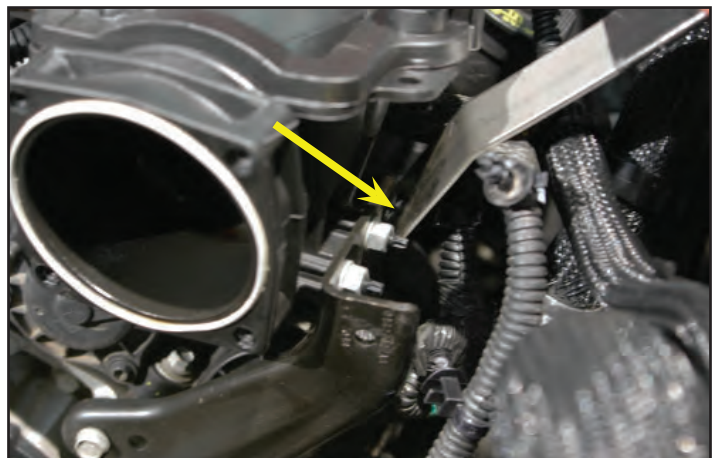

33. Use a 10mm wrench to remove the four upper intake manifold mounting bracket fasteners from the left hand side of the engine. Two are at the forward bracket and two at the rear bracket.

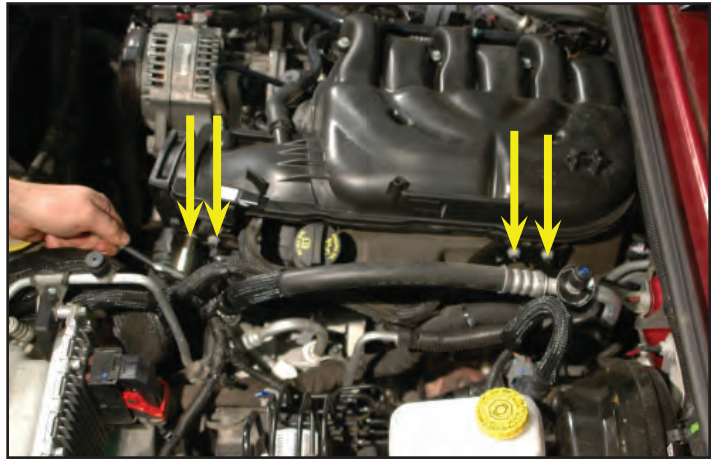

34. Use a 10mm socket to remove the two bolts holding the mounting bracket to the front of the engine on the left hand side. Pull the bracket out of the engine and set aside, this will be reused along with the bolts.

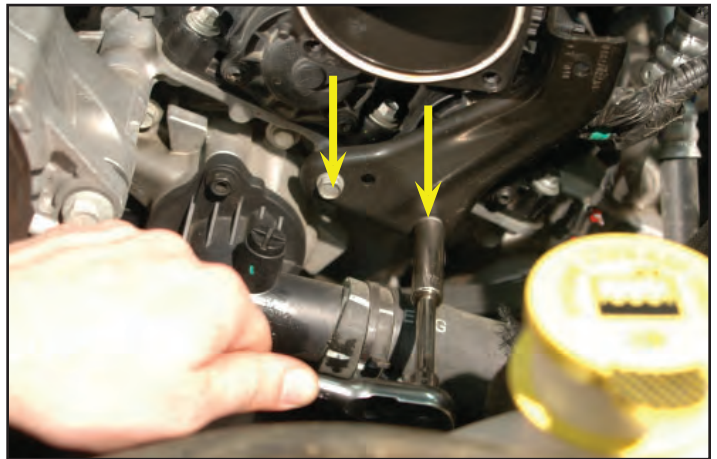

35. Pull the EVAP hose and the PCV hose off the hose barbs on the front-right side of the upper intake manifold.

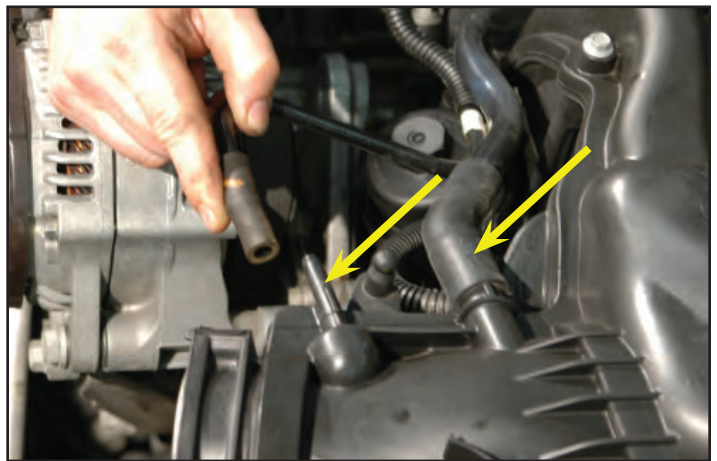

36. Pull the brake booster vacuum hose from the front-left side of the upper intake manifold.



37. Disconnect the vacuum tubes on the right side of the upper intake manifold from their molded retaining slots.

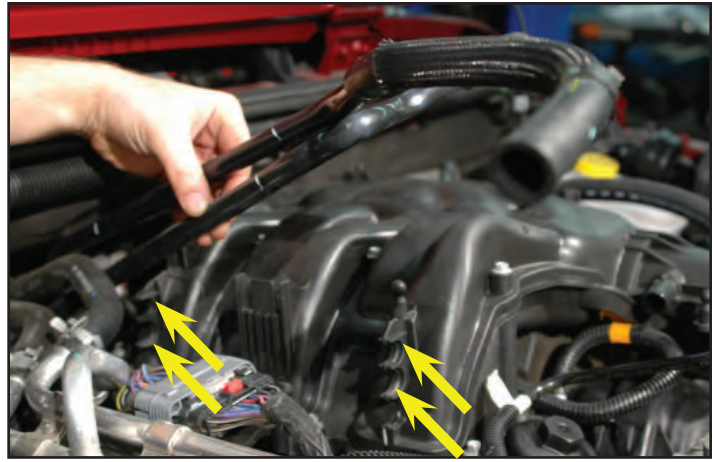

38. Remove the PCV vacuum tubes connected to the back of the valve covers from the vehicle. The left hand side PCV tube will be reused and components of the right hand side PCV tube will be reused. If it's difficult at this time to remove the tubes completely, it's helpful to tuck the tubes up out of the way by securing to the cross deck wiring harness using the provided zip ties.



39. Using the tree clip removal tool carefully pry up on the base of the right hand side main wiring harness connector to release the two mounting tree clips from the bracket below.



40. Use a 10mm socket to remove the fasteners holding the right hand side heater tube/wiring harness bracket to the engine. Two bolts are closest to the intake manifold, two nuts are holding the heater tubes to the bracket, and two other nuts are near the base of the valve cover, between the battery-box and where the bracket bends down toward the exhaust manifold. (see next step)



41. This picture shows the engine out of a vehicle for clarity and illustrates the location of the two lowest bracket mounting nuts.

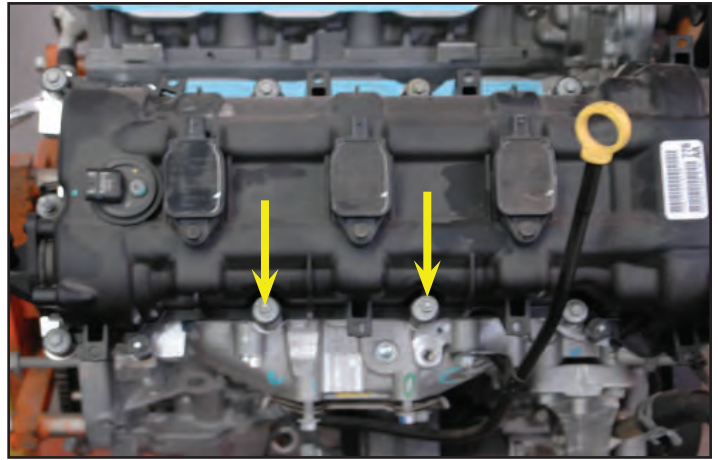

42. Carefully remove the tree clip from the rear of the bracket using a tree clip removal tool.

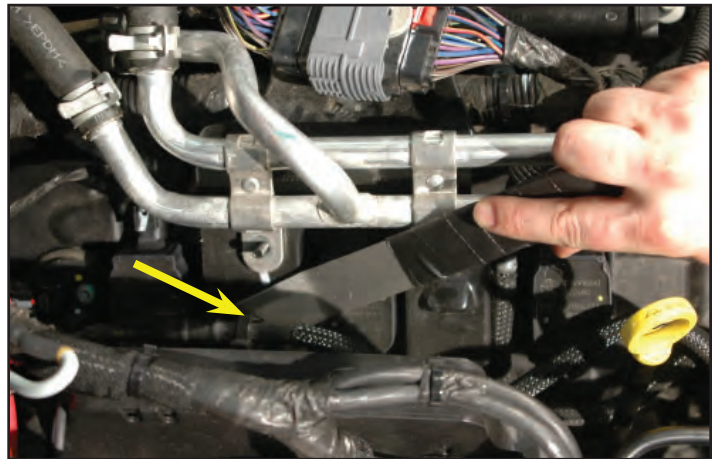

43. Carefully remove the tree clip from the front edge of the bracket using a tree clip removal tool.

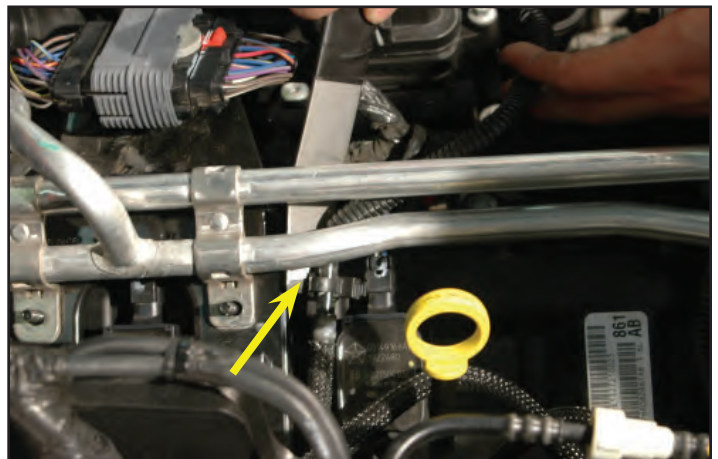

44. Lift up on the heater lines, slide the bracket down toward the exhaust manifold and remove the bracket from the vehicle. This bracket will not be reused, store it in a safe place if you intend to return the vehicle to stock at a later date.



45. Carefully use a tree clip removal tool to disconnect the two tree connectors holding the main wiring harness to the back, right-hand side upper intake manifold.



46. Use an 8mm socket to remove the seven intake manifold mounting fasteners. Three are on the top, and four are at the base of the intake manifold. Pull up and twist the upper mounting bolts counter-clockwise to have the bolts held in the extended position.



47. Lift up on the right hand side of the upper intake manifold then slide the assembly to the right while lifting to remove the assembly from the vehicle.



48. Carefully remove the OE throttle body gasket from the intake manifold removed in the last step. **NOTE: Set this gasket in safe place so that it can be installed into the supercharger in a later step.**



49. Carefully remove the intake manifold gaskets from the vehicle.



50. Use a shop vacuum to remove any debris on and around the intake manifold.



51. Use isopropyl alcohol or other non-petroleum based solvent to carefully wipe clean the intake manifold ports.



52. Cover the exposed ports with tape to prevent contamination of the engine with debris.

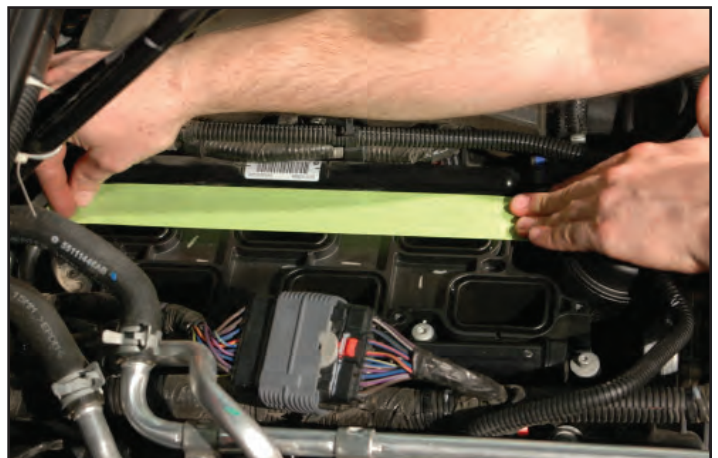

53. Remove the left hand side foam insulation from over the valve cover.



54. Disconnect the EVAP hose by the fuse center by pulling up on the release tab and separating the two components. These are located next to the fuse box.



55. Carefully open the clamp holding the forward piece of the EVAP tube by prying on the center just above the split. This clamp pivots up.



56. Remove the forward section of the EVAP tube from the vehicle.



57. Carefully remove the fitting from the hardline that was removed in the last step and set aside to be used in a later step. **Note: Be careful not to damage the O-ring on the fitting.**

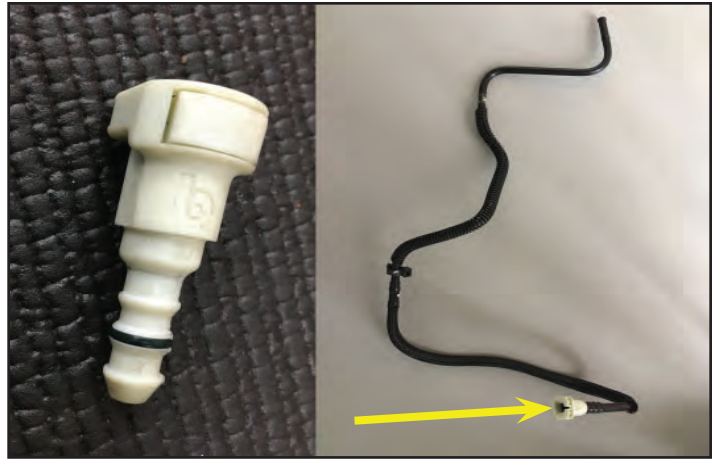

58. Pull the blue locking clip from the front-left side fuel rail.



59. Disconnect the two clamps holding the fuel line to harness.

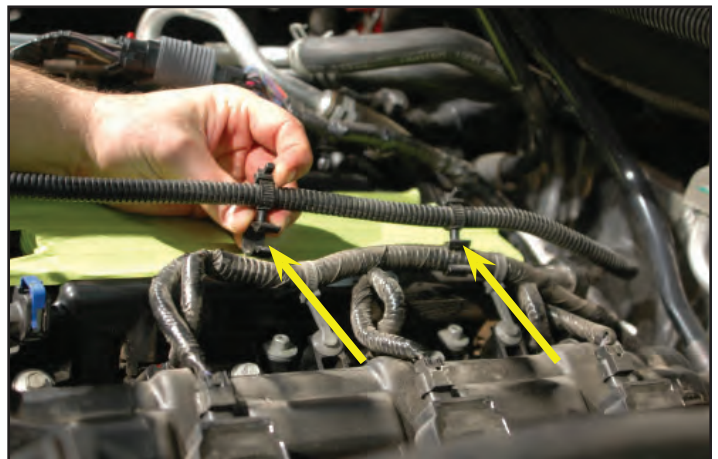

60. **Have some shop towels ready for fuel spillage. Wear safety glasses while removing the fuel line fittings and ensure that there are no ignition sources.** Rotate the fuel line to expose the white locking clip on the bottom. Carefully remove this locking clip out and pull the fuel line off the fuel rail. Have some shop rags handy to catch any residual fuel in the fuel line. Dispose of contaminated shop towels in an appropriate manner.



61. Pull up on the fuel injector locking clips, and squeeze the release tab to remove the six fuel injector connections (three each side).



62. Carefully disconnect the three left side coil connectors.



63. Carefully pull out the four (two each side) wire loom mounting tree connectors holding the injector/coil wire looms to the valve covers.

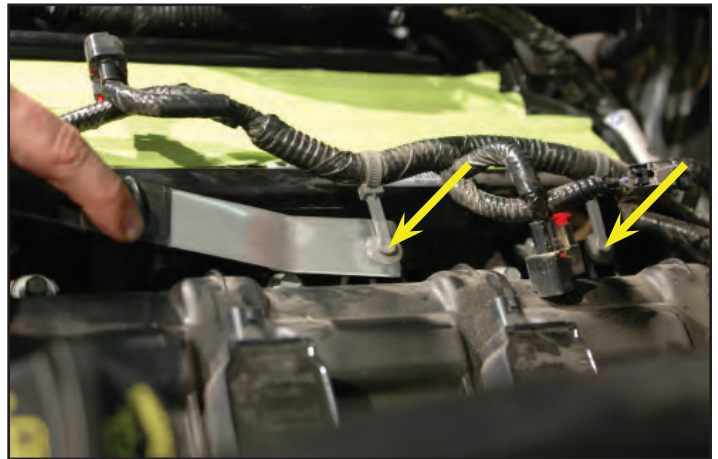

64. Tuck the left hand side wire loom out of the way to the left hand side of the engine compartment.

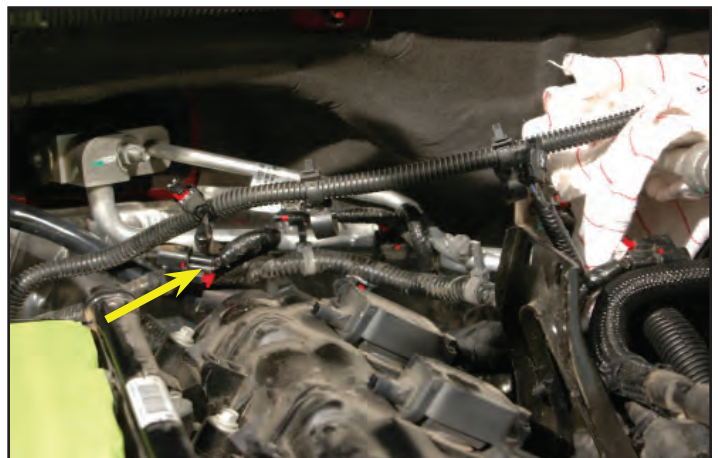

65. Use an 8mm socket to remove the eight lower intake manifold mounting fasteners.



Have some shop towels ready for fuel spillage. Wear safety glasses while removing the fuel line fittings and ensure that there are no ignition sources.

66. Pull the lower intake manifold forward and up. There is one remaining wire tree connector that needs to be carefully pried out of the rear of the intake manifold prior to pulling the manifold out of the vehicle. Remove this connector and set the lower intake manifold aside. **There will still be residual fuel in the fuel rails, so cap this line and have rags or shop towels ready to catch any spilled fuel. Dispose of contaminated shop towels in an appropriate manner.**



67. Use a shop vacuum to clean any debris from the intake ports of the heads.



68. Wipe the ports clean using isopropyl alcohol or some other non-petroleum based solvent.



69. Place strips of tape over the intake ports to protect the engine from debris contamination.

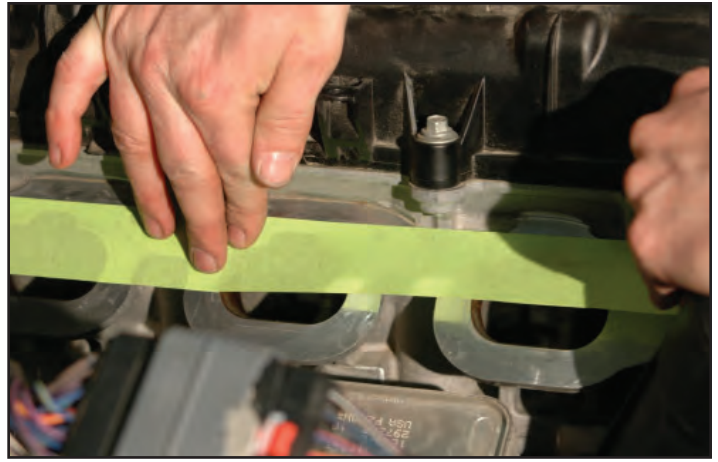

70. Use a long ½" drive breaker bar to turn the tensioner clockwise (if facing the alternator from the front of the vehicle). With the help of an assistant, compress the tensioner and remove the accessory drive belt.



71. Disconnect the alternator voltage control connector.

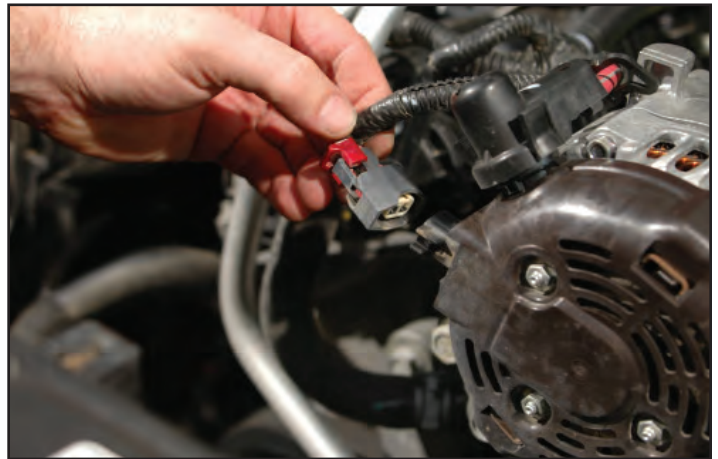

72. Disconnect the alternator positive battery cable using a 13mm socket.



73. Remove the two upper 15mm alternator mounting bolts securing the alternator to the engine and the two lower 13mm bolts holding the alternator to the mounting bracket.

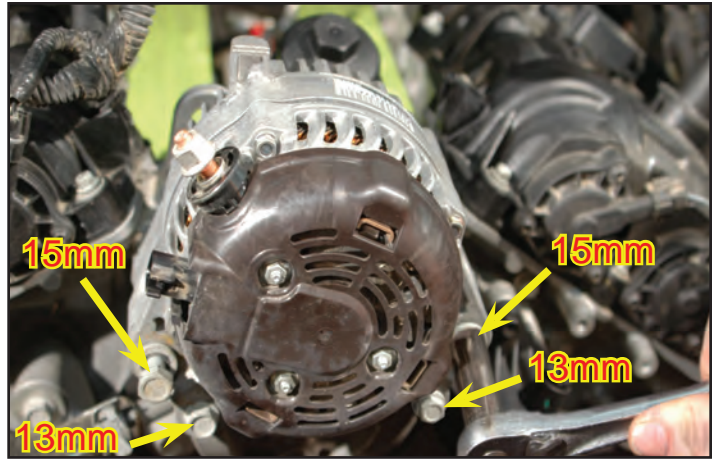

74. Remove alternator from vehicle, set aside for reinstall in a later step.

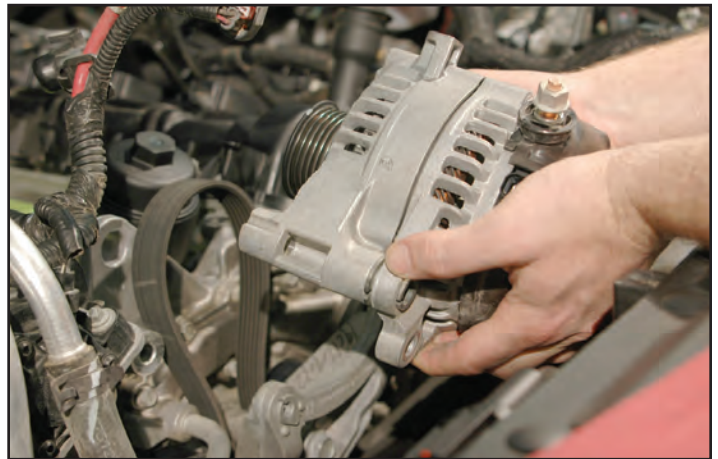

75. Remove the two remaining fasteners holding the alternator mounting bracket to the engine using a 13mm and 16mm socket.

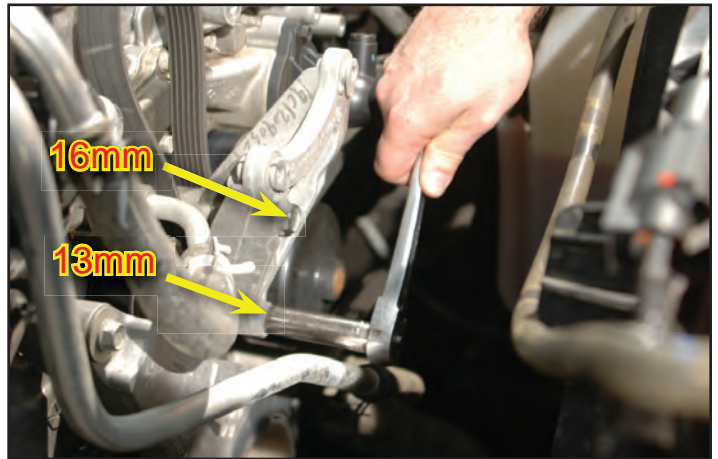

76. Remove the alternator mounting bracket. This bracket will be reinstalled later.



77. Remove the accessory drive belt from the engine. This belt will be replaced with a provided accessory drive belt that will incorporate the supercharger drive pulley into the belt routing.



78. If you didn't remove the two PCV vacuum tube assemblies earlier and tied them up instead, remove the zip tie holding the vacuum hoses to the cross deck harness. These should be accessible now, remove the two PCV vacuum hoses by pulling the rubber connectors off the PCV barb at the back of each valve cover.



79. On the right hand side the main wiring harness runs parallel to the valve cover. At the center connector, first pull the red locking clip out, then slide the gray sleeve over (to the left in this picture) to allow this connection to be separated. Disconnect the plug. Use a 13mm socket to remove the right idler pulley that is just above the tensioner pulley.

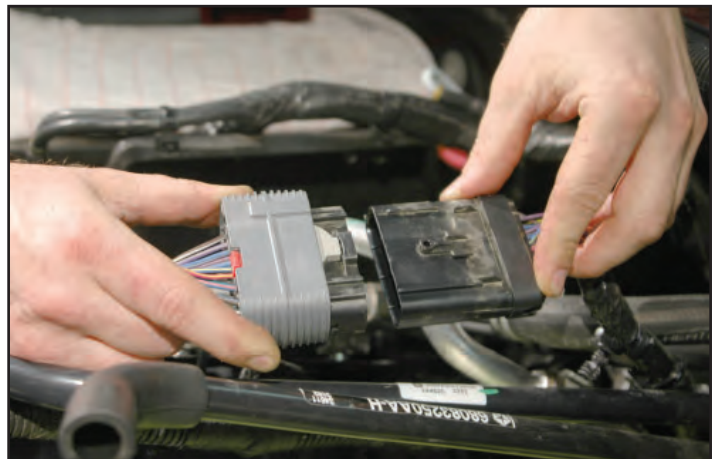

80. The following steps will include installation of several hoses. Please be aware that this kit contains two extra 1/2" spring clamps that will not be needed for this application.



81. Remove LH PCV hoses from the rear of the cam cover (driver side) by pulling it rearward in vehicle to release. (It will not have clamps). This assembly has been highlighted in green.

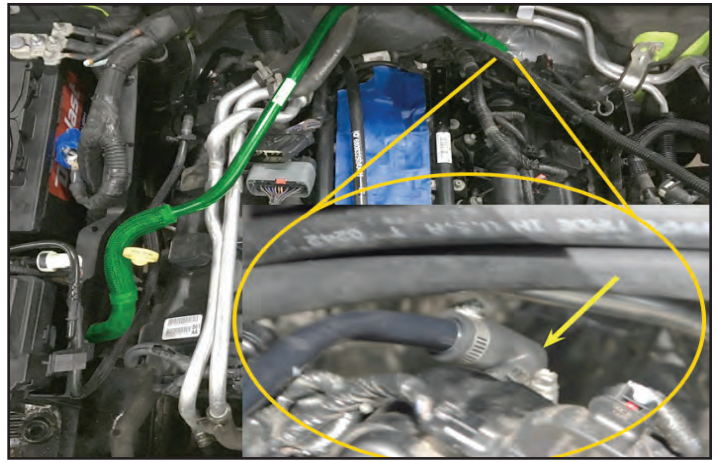

82. With the LH PCV hose removed from the vehicle, rotate the rubber 90-degree connector (shown with an arrow) to break it free from the nylon tube.

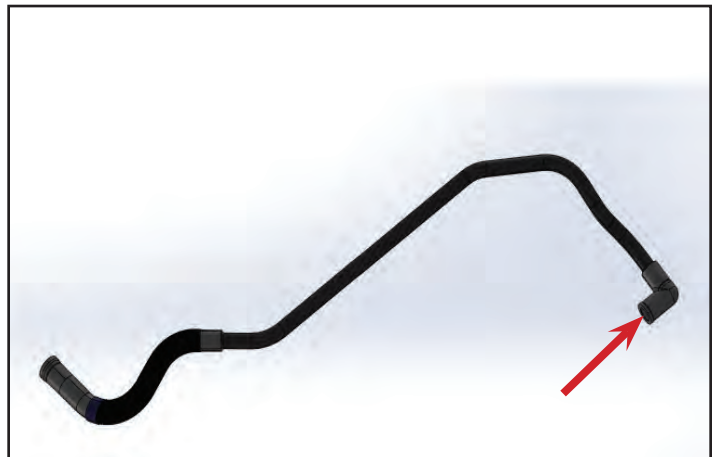

83. Use the provided 5/8 fuel safe hose (3 inches long) and the 5/8 plastic mender to extend the LH PCV hose. Use clamps in the 2 red arrow locations. **NOTE: The 5/8" mender and 3" hose section will be pre-assembled**

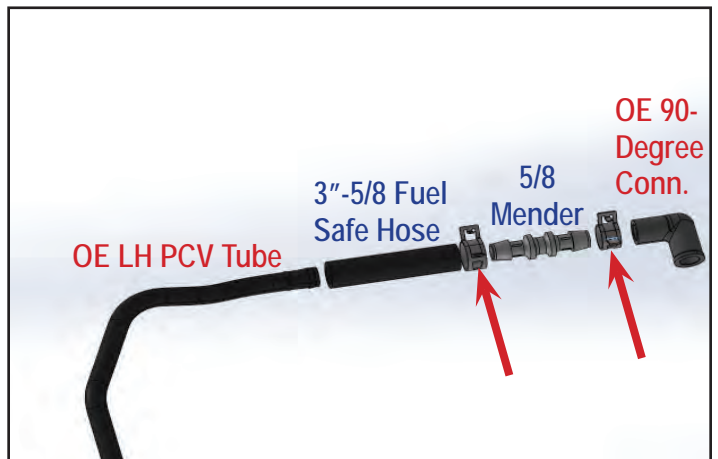

84. Set the completed LH PCV hose assembly in a safe place for use in a later step.

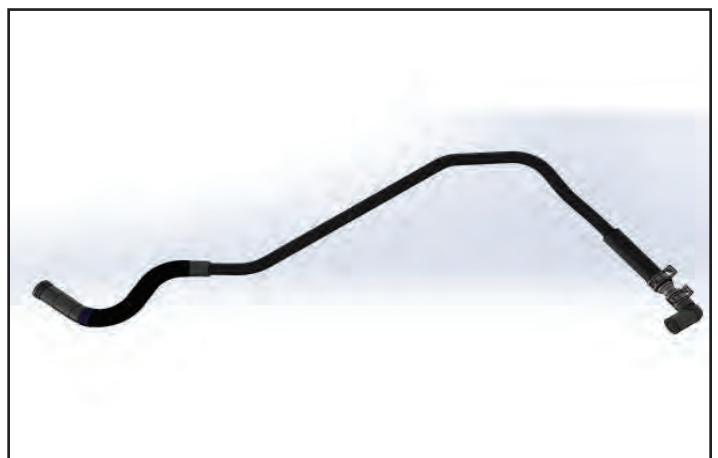

85. The heater hose / tube assembly needs to be removed. There will be some residual coolant in the hose, to protect the ports, place some shop towels down over the intake ports of the heads in the valley cover. The tape should still be covering the ports at this time.



86. Release clamps and remove hoses from the ports at the dash panel as shown.

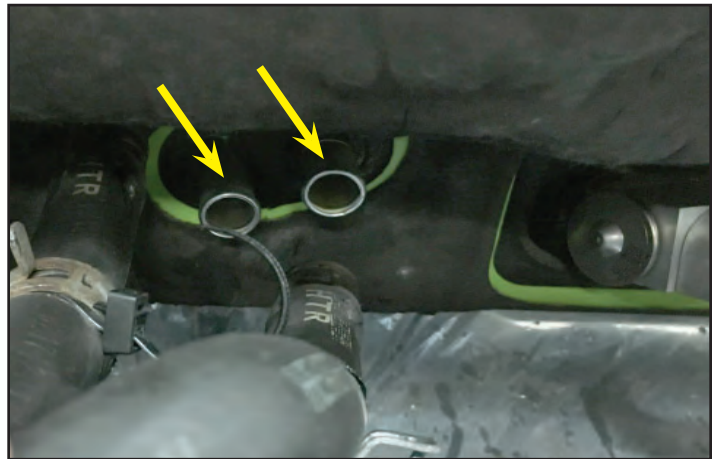

87. Release clamp and remove tube from oil cooler hose as shown.



88. At the front of the engine release the clamps and remove hoses on the upper and lower ports as shown.



89. Remove the Heater hose / Tube assembly from the vehicle.



90. This point in the installation is the most favorable time to replace the spark plugs: Unplug and remove electrical connector from the Coil Pack.



91. Loosen the captive bolt to remove the coil. Once the bolt is loose, pull up to release coil boot from the plug.



92. Use a spark plug socket and extension to carefully remove the spark plugs.



93. Verify that the gap is 0.035" on each new spark plug before installing. **Torque to 22 ft-lbs.**



94. Apply some dielectric grease to the end of the coil boot before re-installing.



95. Once the coil is re-installed and the bolt is tight, reconnect the electrical connector. Repeat this process 5 more times to change out the remaining spark plugs before proceeding with the installation of the supercharger hardware.

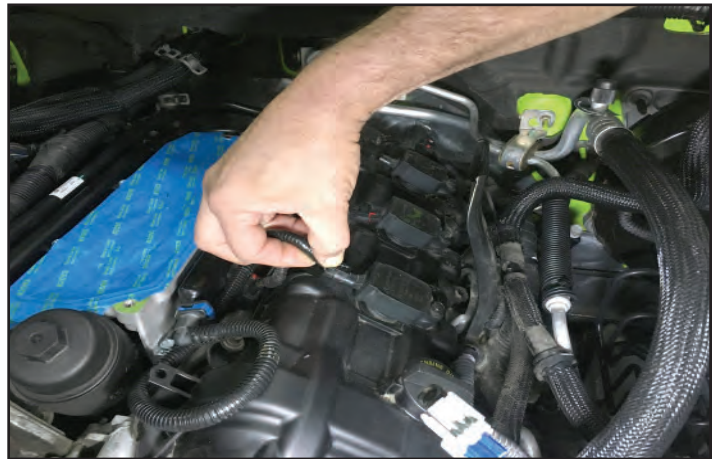

96. Remove RH PCV hose from the rear of the cam cover (passenger side) by pulling it upward in vehicle to release. (It will not have clamps)



97. Remove the RH PCV hose from the vehicle for modification. (Highlighted in green here)



98. With the RH PCV hose removed from the vehicle, rotate the rubber 90-degree connector to break it free from the nylon tube.



99. Use the provided 5/8" plastic mender to connect the OEM 90-degree end from the last step to the provided 5/8" formed PCV hose as shown. Use clamps in the 2 red arrow locations. **NOTE: The 5/8" mender and formed hose section will be pre-assembled.**



100. Install the RH PCV hose onto the port on the RH rear cam cover (passenger side) and route as shown (highlighted in green). **NOTE: Lower Intake Manifold will not be in place at this point in the installation. Intake is shown for reference only.**



101. Locate the supplied 5/8" heater hose, using a 5/8" spring clamp attach the hose at the arrow location.



102. Using a provided 5/8" spring clamp install the other end of the heater hose from the last step (highlighted in green) to the outboard port on the Dash Panel shown with the arrow.



103. On automatic vehicles the Transmission dipstick tube will need to be moved down to make room the Intercooler reservoir. Gently push the dipstick down until it is under the new heater hose routing.



104. Locate the OE Oil Cooler Hose, check for damage or cracking, replace if needed.



105. Remove 1.5" from the OE Oil Cooler Hose shown. The section shown here will be discarded. Make sure to cut the hose straight and install one of the provided worm gear clamps to the hose.

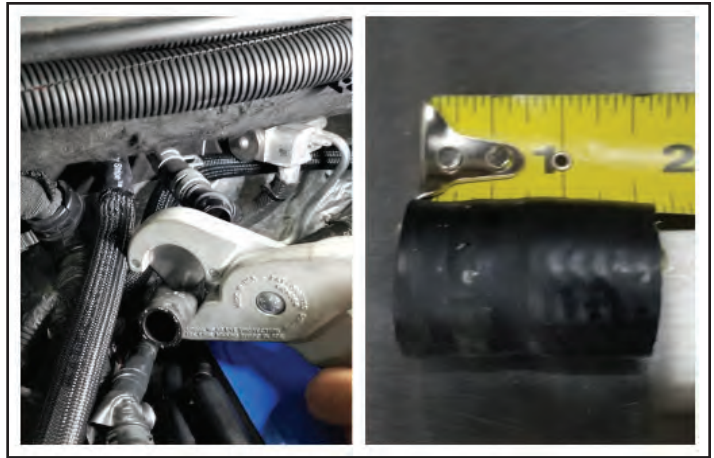

106. Locate the supplied replacement heater hose assembly.

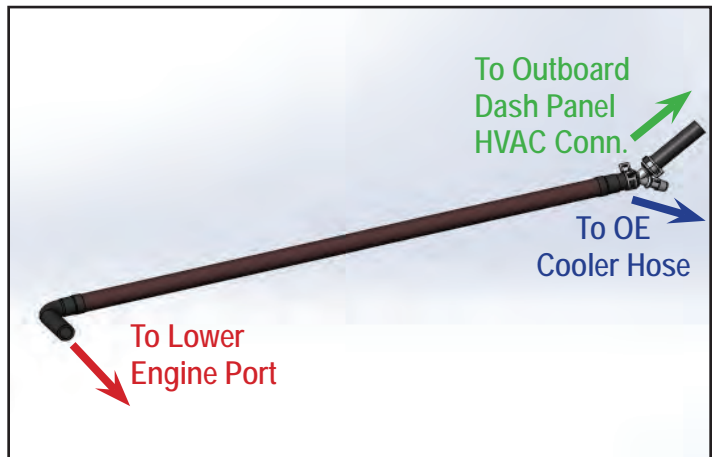

107. Install the new Heater Hose Assembly (highlighted in green) into the OE Oil Cooler Hose and secure with a worm gear clamp where shown with the arrow. Also connect the 4" hose section of the supplied heater hose assembly to the outboard dash panel HVAC connection shown and secure with the provided spring clamp.



108. At the front of the engine, route the hose from the last step down in front of the radiator hose and fan shroud. Use a 3/4" spring clamp and install the remaining 90 degree end of the Heater Hose Assembly to the lower port on the engine shown with an arrow.



109. Remove the OE Oil fill extension by carefully releasing the tab shown with arrow and then rotating clockwise.



110. Remove the OE Oil Cap from the extension tube and re-install cap directly into the LH cam cover as shown.



Have some shop towels ready for fuel spillage. Wear safety glasses while removing the fuel line fittings and ensure that there are no ignition sources.

111. To remove the OE Fuel Rail assembly, use T30 Torx to remove the 4 bolts. Then gently pull up to release the rail and injectors from the OE Lower Intake Manifold. **NOTE: Be prepared for fuel spillage - the Fuel Rail will still have some fuel inside.**

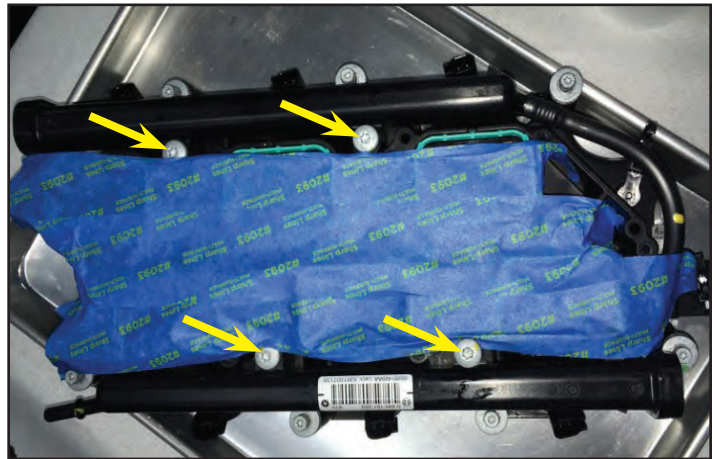

112. Magnuson Lower Intake Manifold subassembly:
Carefully unwrap the Lower Intake Manifold with pre-installed gasket. Also gather the supplied Lube, 6 - upgraded Fuel Injectors, the OE Fuel Rail and 4 - M6 x 35mm bolts (bolts not shown in picture) **NOTE: Be careful not to cut or damage the Intake Gasket while unwrapping or during assembly.**

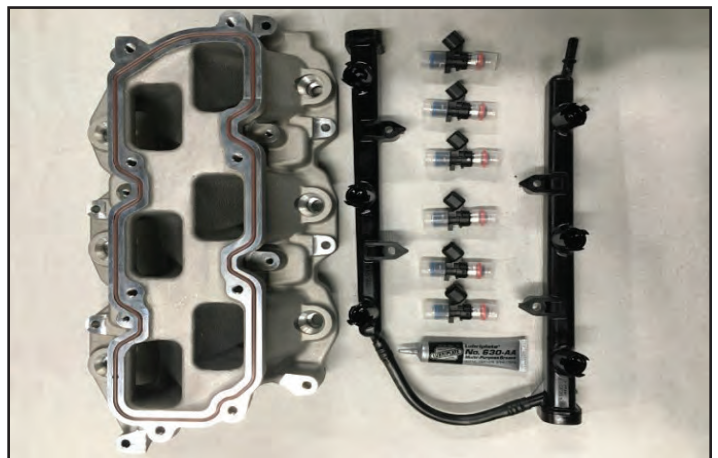

113. Install Supplied Fuel Injectors into OE Fuel Rail using lube on the O-rings to prevent damage and ease the installation process.



114. Reinstall stock fuel rail onto Magnuson Lower Intake Manifold. Use 4 supplied M6 x 35mm bolts and **torque to 89 in-lbs.**



115. Here is a top view of the fuel rail location. **NOTE: The Fuel X-Over line will be around the rear of the Lower Intake Manifold as shown for proper Fuel Rail orientation. (red arrow)**



116. Remove 6 OE Intake Manifold Gaskets from the OE manifold. These will be installed in the Magnuson lower manifold.



117. **NOTE: If your vehicle has high mileage or gaskets show signs of wear. (see example picture) Replace gaskets with the appropriate OEM gasket set PN#:5184331-AC**

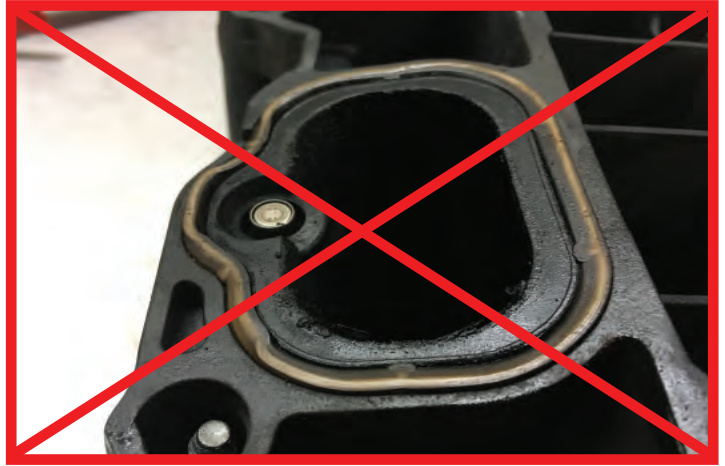

118. Install the 6 OE Intake Manifold Gaskets from two steps ago into the Magnuson Lower Manifold.

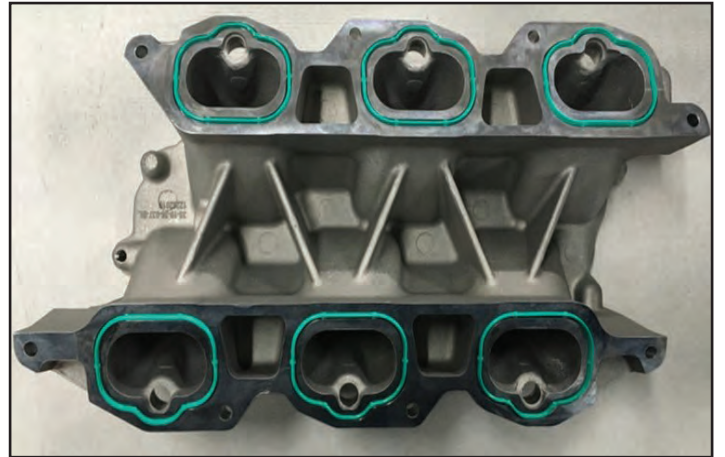

119. Remove the shop towels and the tape from the heads. Be careful to prevent any debris from falling into the ports



120. Use isopropyl alcohol or some other non-petroleum based solvent to wipe the head surfaces clean of any tape residue.



121. Install completed Lower Intake Manifold Assembly onto the engine. Hand tighten fasteners:
 Four M6 x 40mm bolts are used on the inner bolts.
 Four M6 x 60mm bolts are used on the corners.

Cover the top of the intake with tape as shown to prevent debris from getting in your engine.



122. Use this image to sequence the torquing of your lower intake manifold mounting bolts. Do NOT torque each bolt down to full specs in a single step. Rather gradually bring each bolt up to specifications rotating in this pattern. The final **torque should be 106 in-lbs**. There is a larger version of this diagram at the back of this manual.

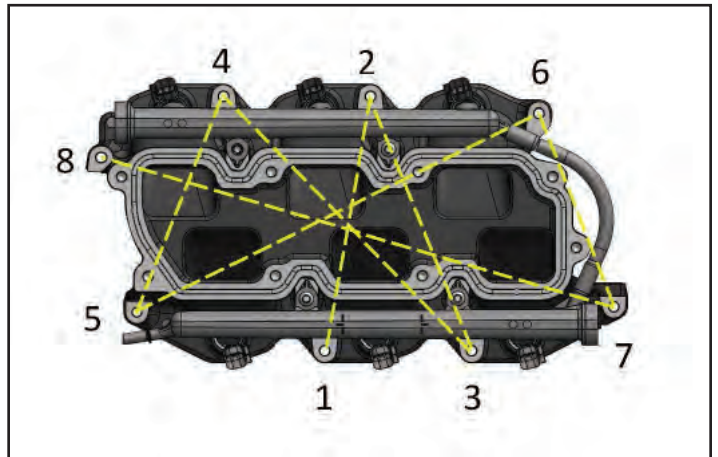

123. Plug in 6 injector connectors and depress the red locking tab.



124. Reconnect the Fuel supply Line to the Fuel Rail. Make sure to route the line as shown and engage the blue lock to ensure connection.



125. Install the LH PCV hose assembly onto the port on the rear of the LH cam cover (driver side) and route next to the fuel rail as shown. Make sure to run the PCV tube on top of the alternator ground cable. Add zip tie to retain the PCV tube in the location shown with arrow.

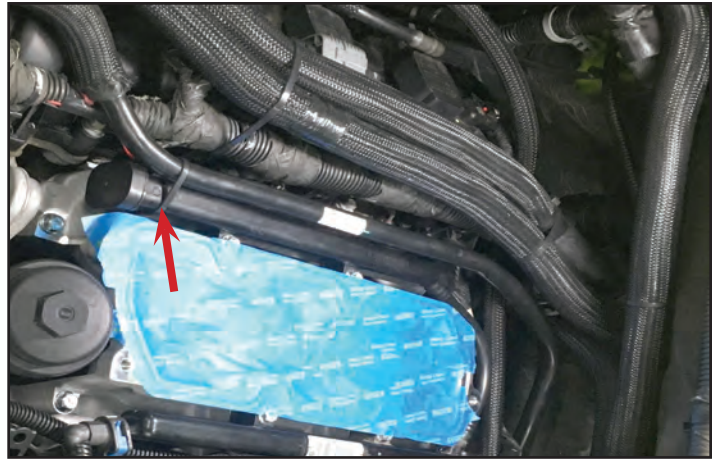

126. Carefully manage all wiring down between the fuel rail and cam cover to provide clearance to the upper intake and supercharger which will be installed in later steps. Remove the stock push pins from the harness and retain with zip ties as shown with red arrows.



127. Locate the OE fuel vapor tube that was disconnected in an earlier step that points to the front of the vehicle. Gently rotate this line 180 degrees clockwise so that it points toward the rear of the vehicle.

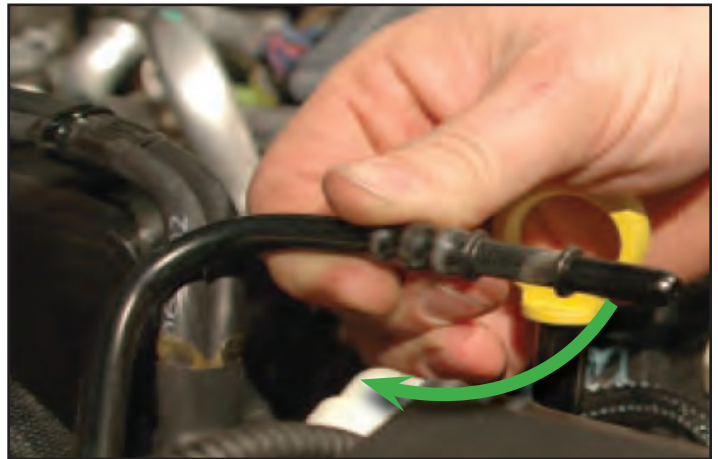

128. Gather the Quick Connector removed from the OE vapor line in an earlier step.



129. Install connector to supplied 5/8" OD fuel line (4.5' long). Install the connector to the rotated OE vehicle line from two steps ago and route as shown. Retain with zip ties to the wire harness in the locations shown with red arrows.



130. Collect the supplied coolant pump, pump bracket, rubber pump isolator (Should be pre-installed on the pump), 2-M6 J-clips and M6 x 20mm bolts (not shown here).

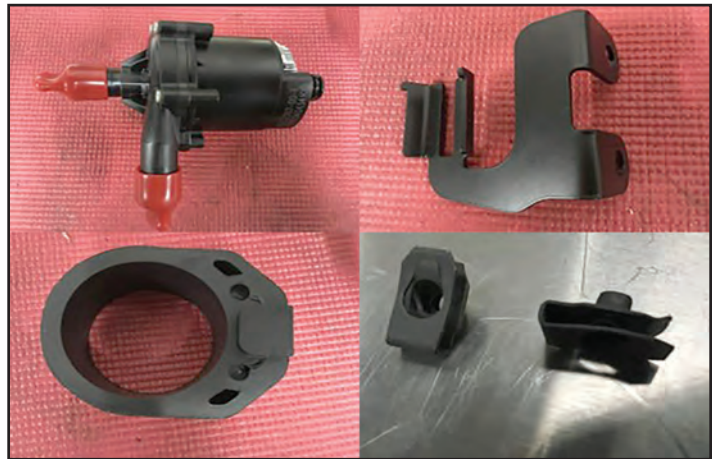

131. The pump should come with the rubber mount pre-installed in the orientation shown. Ensure that the stop hits at the arrow location.



132. You will need to gain access to the front driver side wheel well. (This is easier to do with the wheel removed) Cut out the supplied drill template and line it up at the bottom and then the forward edge of the sheet metal as shown. **NOTE: The Drill Guide Template is located at the end of the manual. Make sure to verify that the printed template is to proper scale by checking the 1-inch marker on the template with a measuring device.**



133. Mark and drill the holes. We recommend a minimum of 1/4" final hole size. After drilling the appropriate size holes it is highly recommended to use touch up paint / clear coat or equivalent to protect the exposed metal from corrosion.

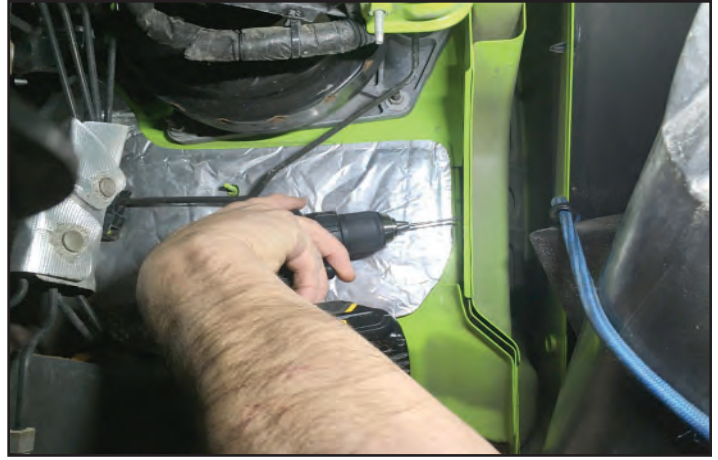

134. Install the 2 provided M6 J-clips onto the bracket as shown.

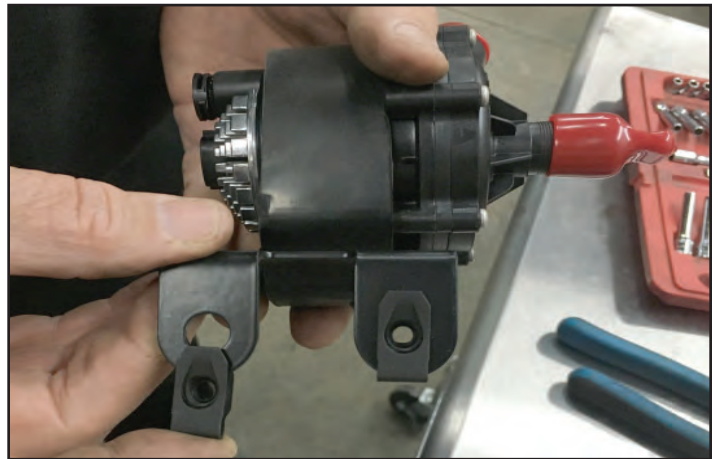

135. Use two M6x20mm bolts to install the bracket where the holes were drilled. Bolts go in from the outside as shown. (make sure the paint has dried) **Note: There will be 3 extra provided M6x20mm bolts that will not be used in this installation.**

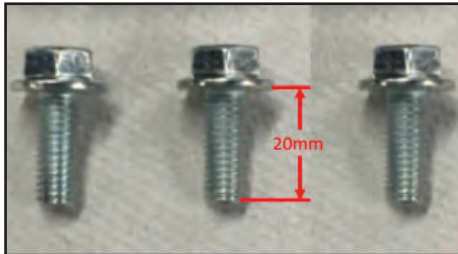

136. Install pump and isolator onto the mounting bracket as shown.

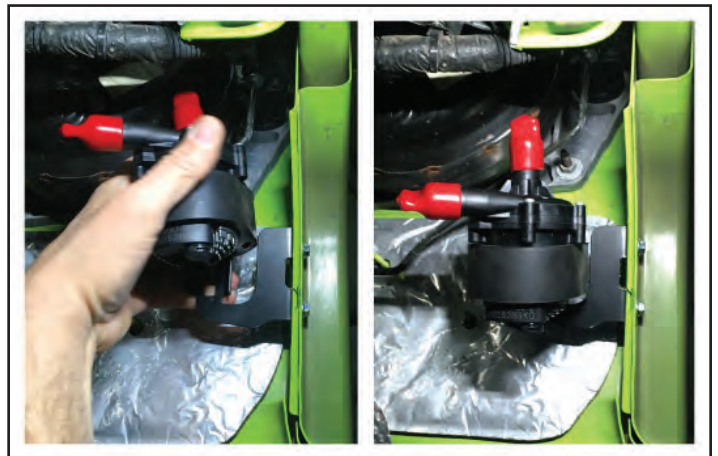

137. Gather the supplied Intercooler Pump Harness.



138. Install the provided fuse in the fuse holder of the intercooler wiring harness and replace the cover.



139. On the inside surface of the battery tray toward the rear there are two holes. Using the provided hardware, attach both the fuse center and the relay to the front hole as shown in this picture.

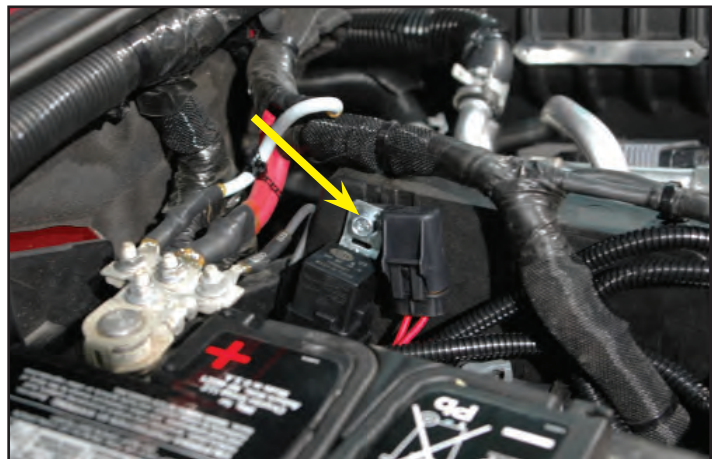

140. Route the split loom covered power connector with the yellow wire incorporated forward. Utilize the vacated clamp of the EVAP center as a mounting point and secure the harness in position by pressing the hinge clamp down over the split loom.

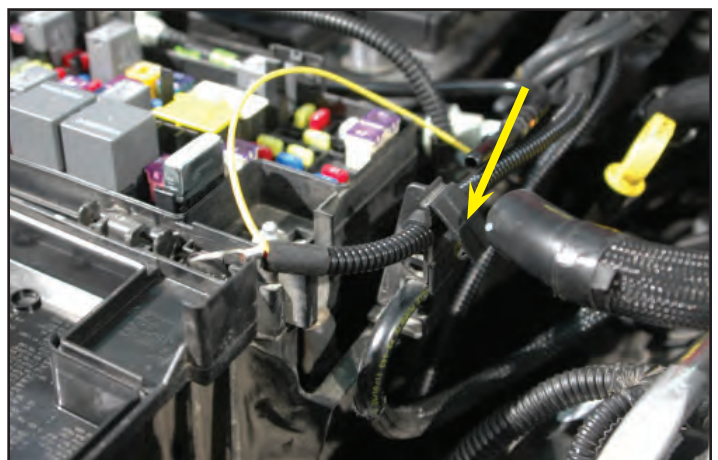

141. Route the black ground wire back to the firewall. Remove the nut on the existing grounding stud and replace incorporating the intercooler harness ground wire.

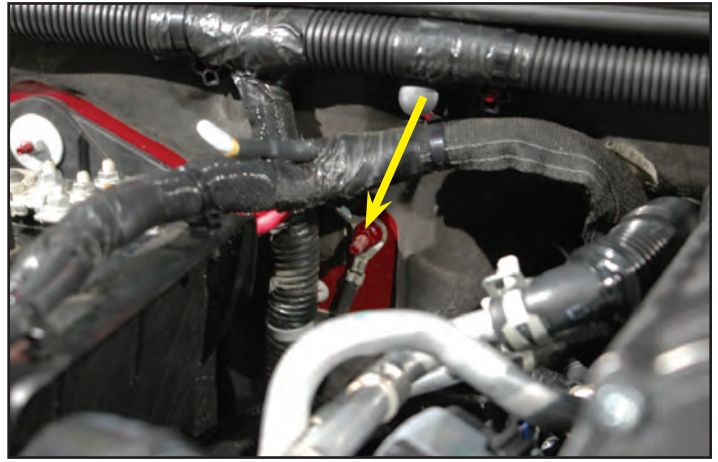

142. Remove the fuse box cover. Use a 1/4" drill bit to drill a small hole in the back wall of the fuse center power lead. Center the hole between the existing fuses beyond as shown.

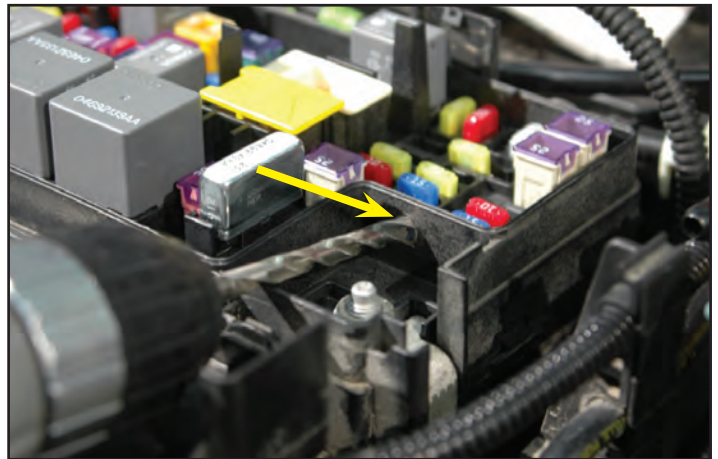

143. Use a 13mm wrench to remove the nut from the hot terminal of the fuse center and replace incorporating the ring terminal on the red wire from the intercooler pump wiring harness.

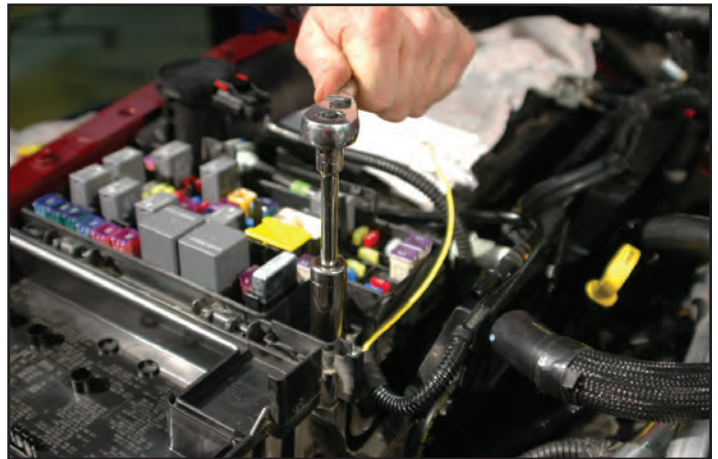

144. Slide the provided grommet over the fuse tap connector onto the yellow wire back down toward the split loom. Route the yellow "trigger" wire through the hole you just drilled and seat the grommet in the opening to seal the box. A dab of silicone will help to maintain a waterproof enclosure.

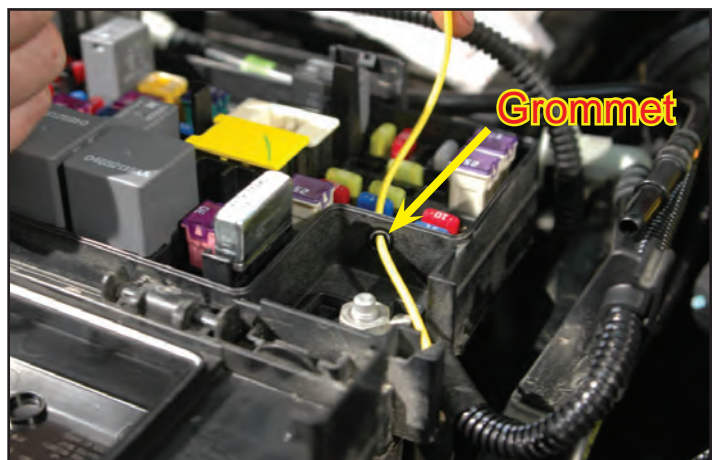

145. Install the provided fuse tap at the end of the yellow wire on one leg of the M37 fuse (fuel pump relay removed earlier).

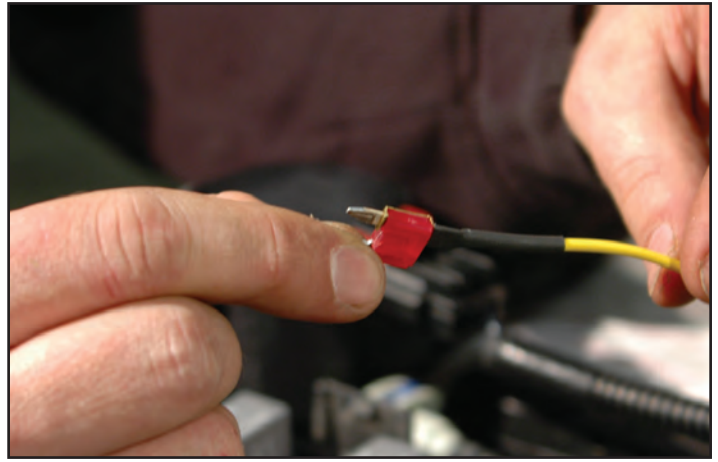

146. Reinstall the fuse in the fuse center M37 slot incorporating the fuse tap.



147. Neatly route the harness (highlighted in green) along the battery tray to the dash panel. Route along the dash panel toward the pump on the driver side.



148. Make the connection to the Intercooler Pump as shown and retain the wire as needed.



149. Here you can see the hose diagram for the intercooler system. These hoses will be connected over the next steps. You will find a larger version of this diagram at the back of this manual.

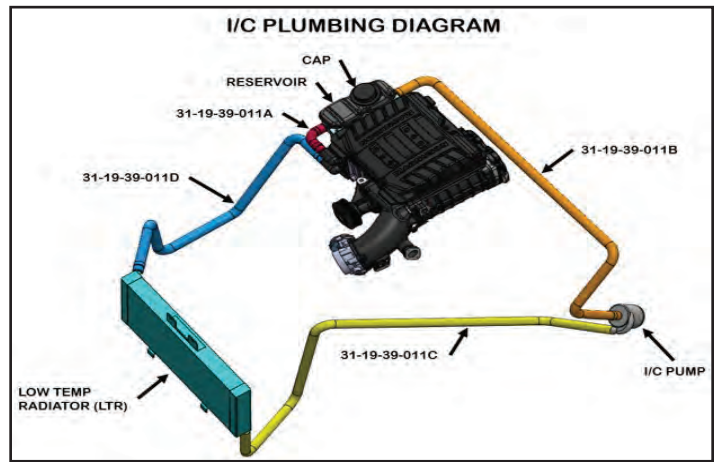

150. Locate supplied $\frac{3}{4}$ " formed hose 31-19-36-011D shown here.

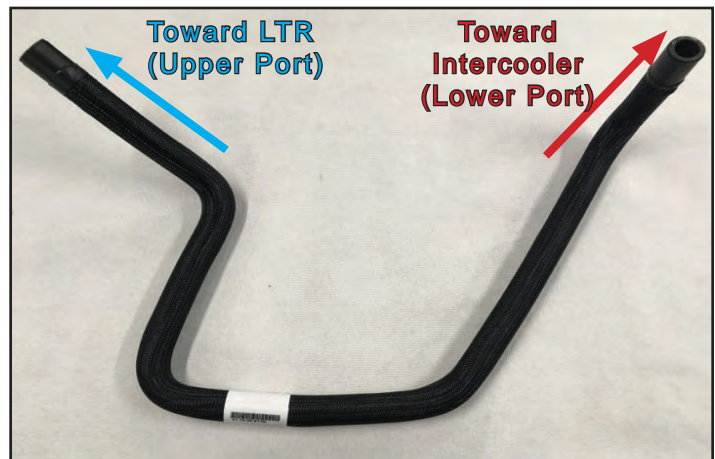

151. Route intercooler hose: 31-19-36-011D through the opening created by removal of the RH side radiator deflector. Gently push the hose (highlighted in green) from inside the engine compartment, you may need to push the hose farther through to help make the clamp connection at a later step.



152. The green highlighted hose: 31-19-36-011D will route as shown so that the air box will be able to be re-installed later without crushing the intercooler hose. Place the end in a safe place until a later step when the connection will be made.



153. Here is another view of the hose 31-19-36-011D routing up to the radiator (highlighted in green).

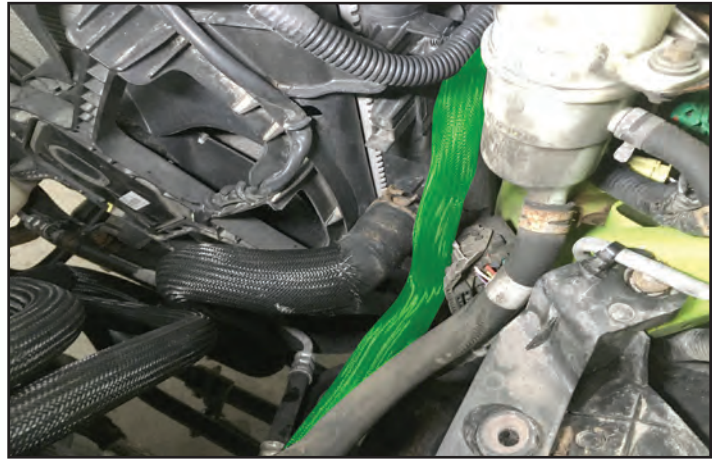

154. Locate supplied 3/4" formed hose 31-19-36-011C shown here.

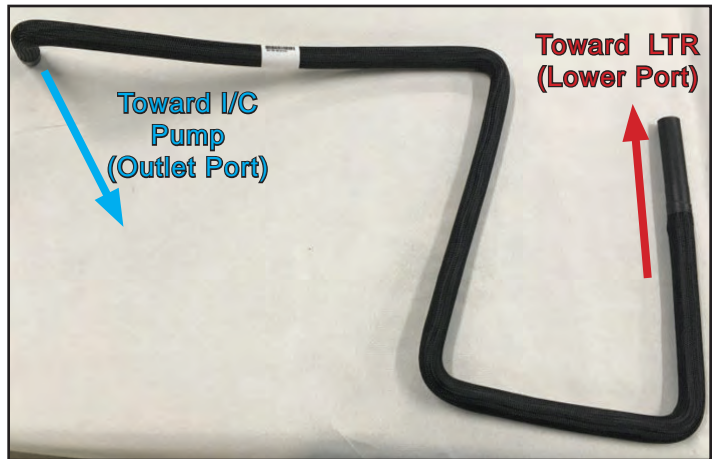

155. Install a worm gear clamp and intercooler hose: 31-19-36-011C to the intercooler pump outlet.

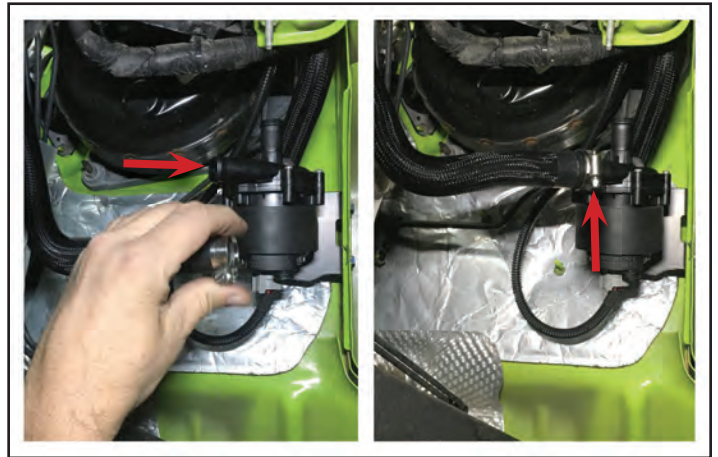

156. Route 31-19-36-011C (highlighted in green) from pump forward along the frame rail between the ABS lines and the inner fender well.



157. Route hose 31-19-36-011C (highlighted in green) over the upper radiator hose and down through the gap shown by the arrow. (just in front of the steering stabilizer bar.)

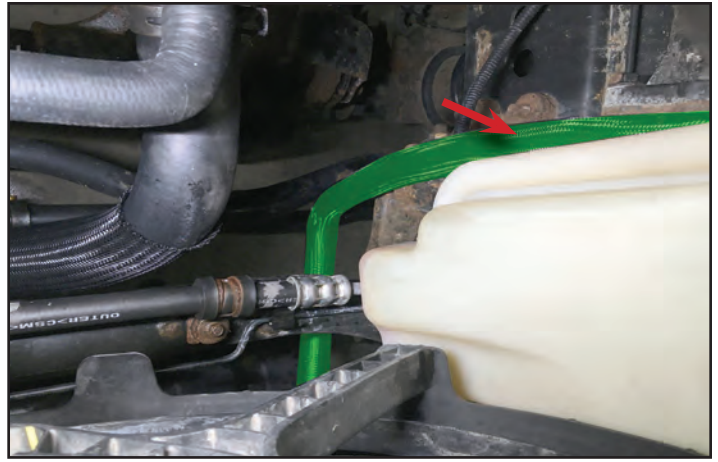

158. Continue routing of 31-19-36-011C under the front suspension sway bar and the bottom of the cooling module toward the front (highlighted in green). The last turn routes up to the position of the lower port of the LTR. Apply a small amount of lube on the inner diameter of the hose to ease the install later.



159. Locate supplied 3/4" formed hose 31-19-36-011B shown here.

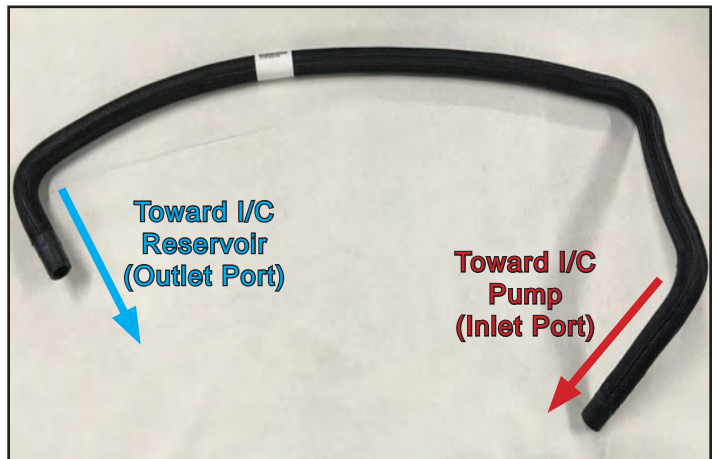

160. Connect intercooler hose: 31-19-36-011B to intercooler pump INLET with a worm gear clamp.



161. Route intercooler hose: 31-19-36-011B along dash panel.



162. Cut two strips of the provided adhesive-back rubber to fit the mounting brackets on the bottom of the low temperature radiator (LTR).



163. Press the LTR mounting brackets on the lower cross frame rail, and roughly align the holes with the existing holes in the upper cross frame brace.



164. With the LTR loosely in place, use a spring clamp to connect the intercooler hose (highlighted in green) to the upper port on the LTR (passenger side)
NOTE: This will be visible thru the grille opening so we recommend you use one of the black supplied constant tension clamps in this area.

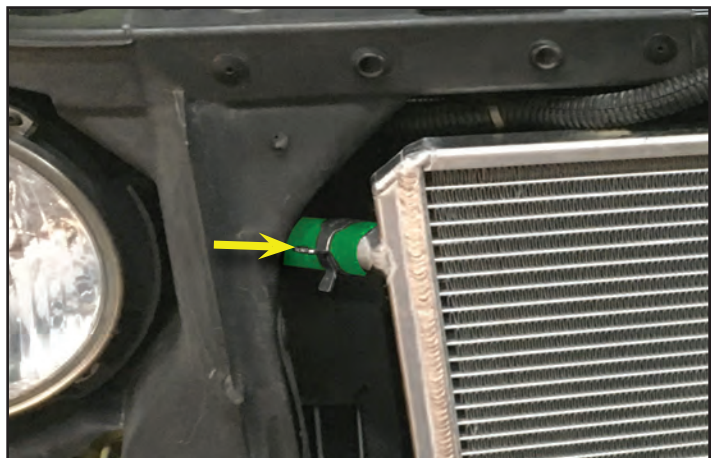

165. Use a spring clamp to connect the intercooler hose (highlighted in green) to the lower port of the LTR (Driver Side). **NOTE: The clamp needs to be oriented as shown to prevent contact & damage to the A/C condenser located behind the LTR.**

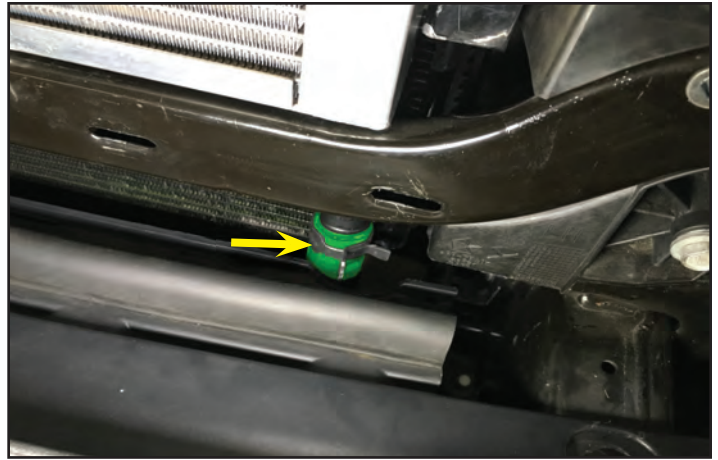

166. Slide the provided double nut plate (shown below) up and into the channel of the upper cross frame brace, and align the nuts with the two existing holes located behind the wiring harness.

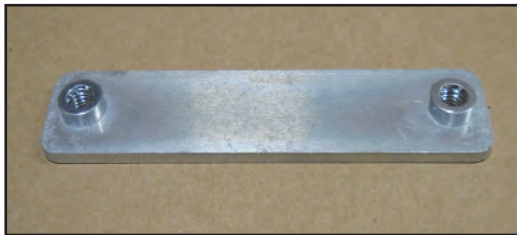

167. Do some final adjusting as necessary and mount the upper LTR mounting bracket to the upper cross frame brace, engaging the two nuts of the double nut plate with the provided bolts. Secure using a 10mm socket.

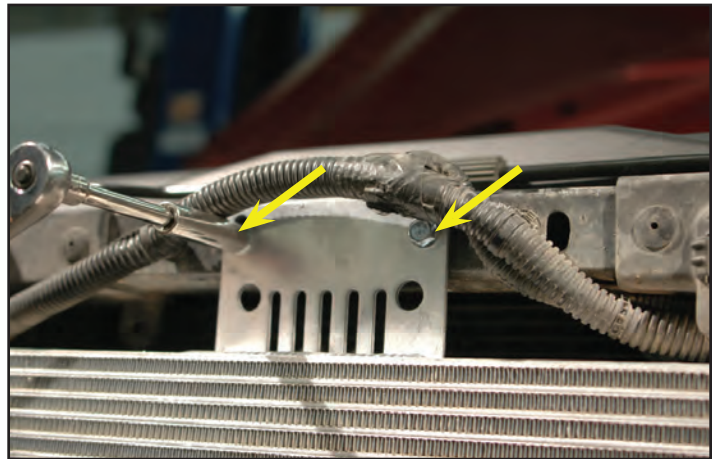

168. Carefully unwrap the Magnuson Upper Intake Manifold Subassembly.



169. Remove the Turret Manifold Assembly by removing the four M6 x 35mm bolts using a 10mm socket. Save these bolts for re-use. Carefully pull the Turret Assembly straight out to disengage the Intercooler Tubes.

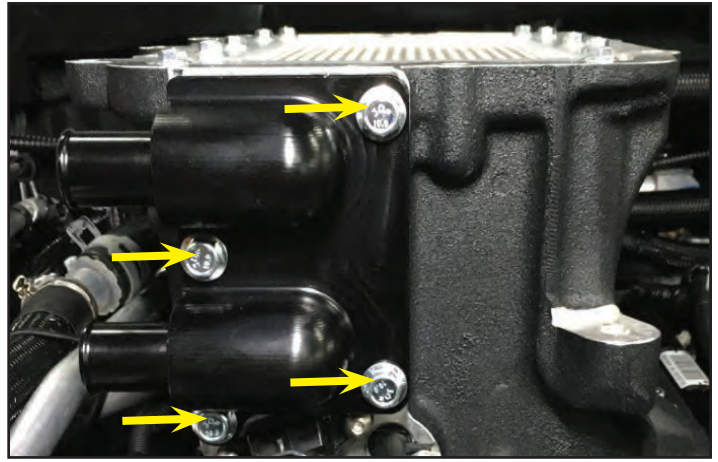

170. Remove Intercooler Tubes by carefully pulling them straight out. (If the Intercooler Tube(s) came out with the Turret Assembly, remove the tube from the Turret.)

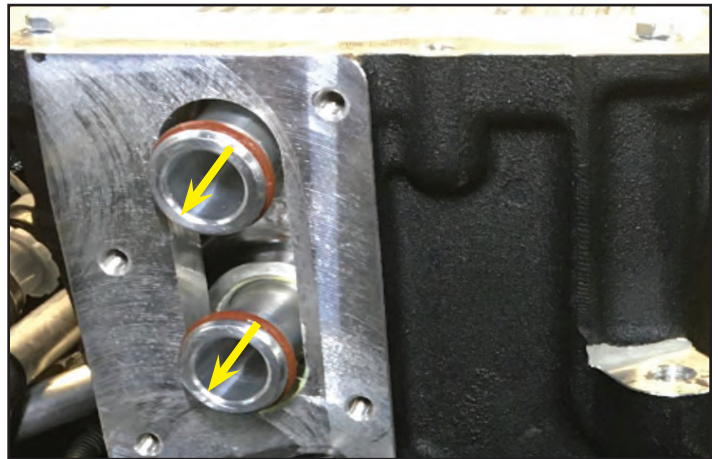

171. Remove the 10 intercooler mounting bolts. (save bolts for re-use)

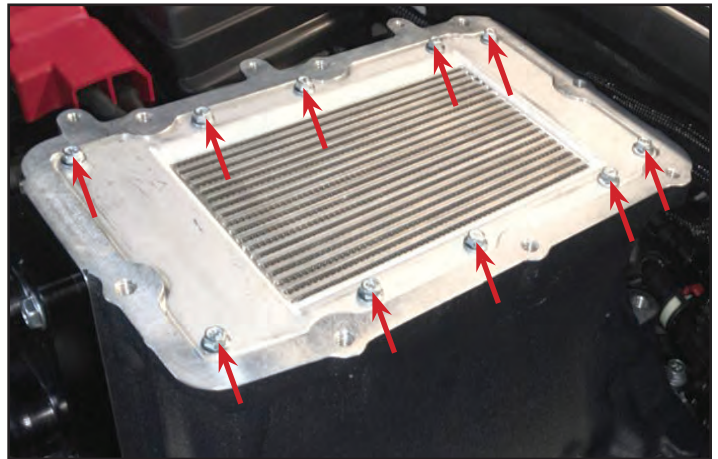

172. Remove the Intercooler by pushing up with your finger on the Intercooler inlet (red arrow). This will allow you to get under the mounting flange. Carefully pull the Intercooler straight out and put in a safe place until needed.



173. Gather the provided MAP sensor and OEM IAT sensor that was removed from the OEM Air Inlet Duct in an earlier step.



174. Install the OEM IAT sensor in the red arrow location using lube and secure it with one provided M5 x 10mm bolt. Using lube on the O-ring, carefully install the supplied 2 Bar MAP sensor into the intake and secure using two internal hex head M5 x 16mm bolts at the yellow arrow locations. **Torque all three M5 bolts to 53 in-lbs.**

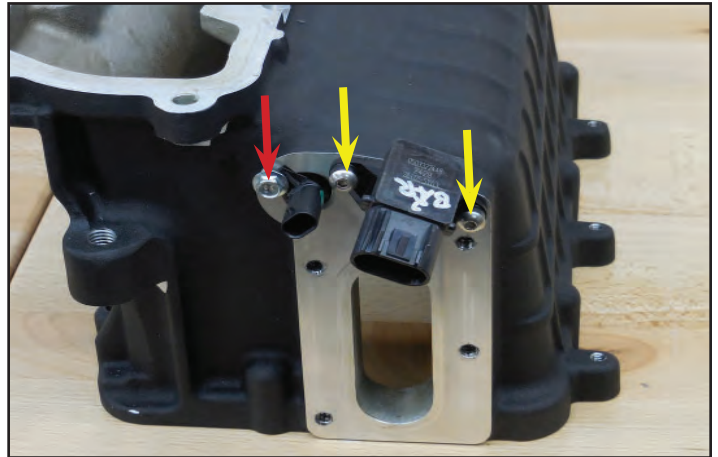

175. **Optional Step:** If you wish to add a boost gauge you will have to remove the threaded plug at the red arrow location and replace it with a 90° fitting like the barbed one shown here. Clock this fitting as shown and attach the hose before installing the upper manifold in the vehicle. This location will be at the back of the engine bay near the firewall which makes it impossible to access once the manifold is installed. **DO NOT forget to connect the gauge if you follow this step!**

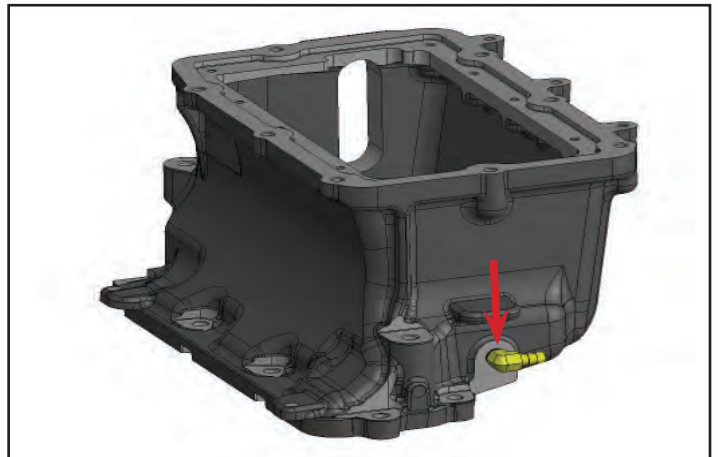

176. Place the upper intake on the lower intake.



177. Apply blue Loctite 242 to the eight provided M8 x 30mm bolts. Install and hand tighten the eight M8 bolts. Do not use the dished head bolts shown below for this.



178. Torque the M8 bolts to 18 ft-lbs in the sequence shown. Slowly approach the final torque specifications as you go through the pattern three times. There is a larger version of this diagram at the back of this manual.

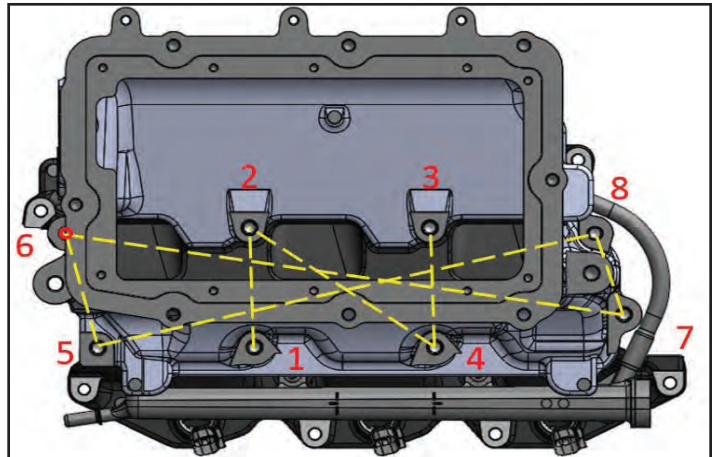

179. Gather the provided IAT sensor extension harness.



180. Locate the loose IAT connector near the front of the engine that was previously disconnected from the OE air induction tube. Connect the male end of the supplied IAT sensor harness extension to the OE connector as shown.



181. Gather the supplied MAP sensor extension harness.

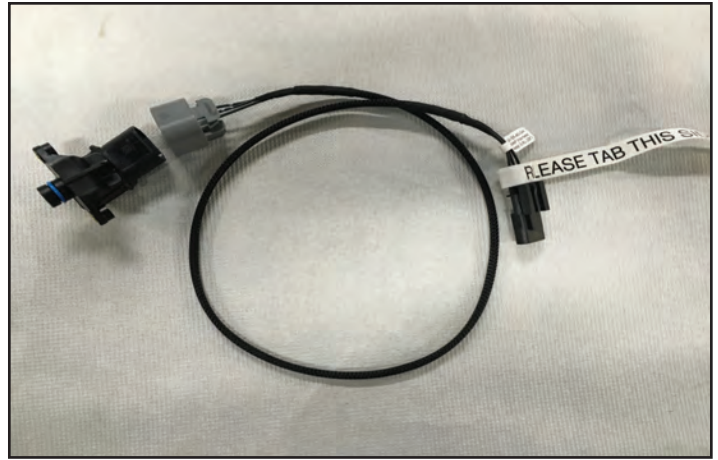

182. Locate the loose MAP connector near the front of the engine that was previously disconnected from the OE Intake Manifold. Connect the free end of the MAP sensor wire extension harness to the existing MAP sensor plug. **NOTE: Each side of the MAP sensor connection has an offset, and the offsets are on the opposite sides from each other! The locking clip will only engage the tab if you align the offsets correctly. You can force the connection with the offsets being on the same side, but in the process you can damage the connectors. ENSURE THE OFFSET OF THE MAP SENSORS ARE ON OPPOSITE SIDES AS SHOWN IN THIS IMAGE.**

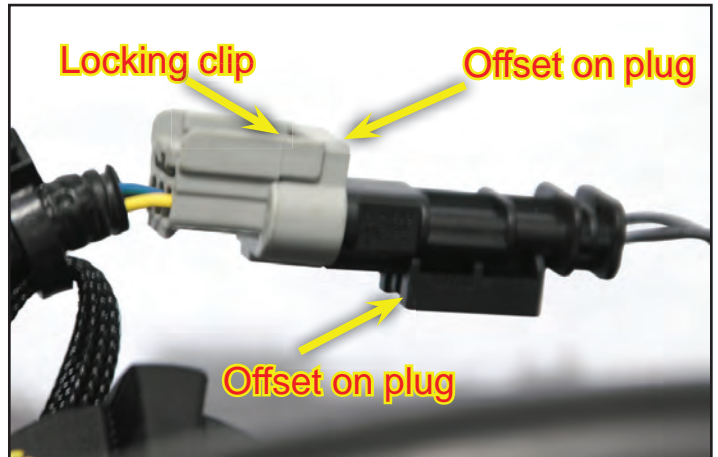

183. Connect the MAP sensor extension at the red arrow location. Connect the IAT sensor electrical wire at the yellow arrow location. **Note: Make sure to route the wires and retain where needed with cable ties. Wires need to be retained so they do not get in the way of the supercharger as it is loaded in position.**



184. Have a friend help you lift the supercharger onto 2 tabs on upper intake manifold. The front tab is shown at the arrow. The other tab is in the back and is shown in the next step. **Apply blue Loctite 242 to the M10 x 40mm bolts and loosely install the front mounting bolt. NOTE: M10 Bolt heads may have 2 different head sizes.**



185. Here is the rear location of the tab for mounting the supercharger. Install front and rear M10 Supercharger mounting bolts. If you have trouble aligning the rear bolt, lightly tighten the front bolt which should align the rear bolt and allow for easy install. Once both bolts are installed, **torque both to 33 ft-lbs.**

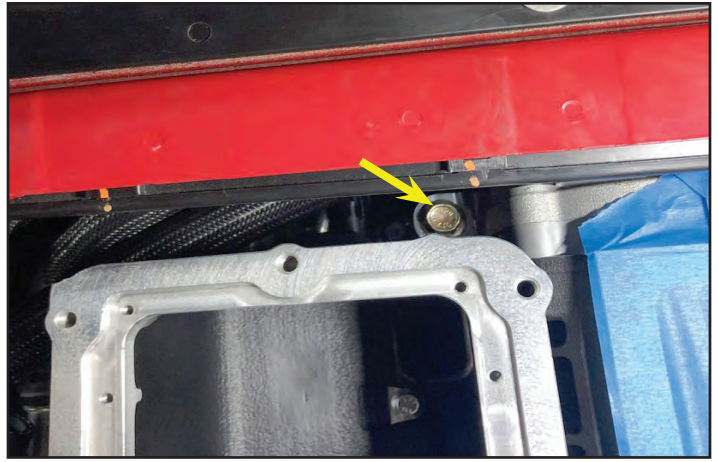

186. Install rear support Z-shaped bracket using **two M8 x 20mm bolts and torque to 18 ft-lbs.** Attach the outboard end of the bracket to the OE Intake Manifold bracket with **two M6 x 20mm bolts and torque them to 106 in-lbs.**



187. Install O-ring into Supercharger inlet EGR flange.

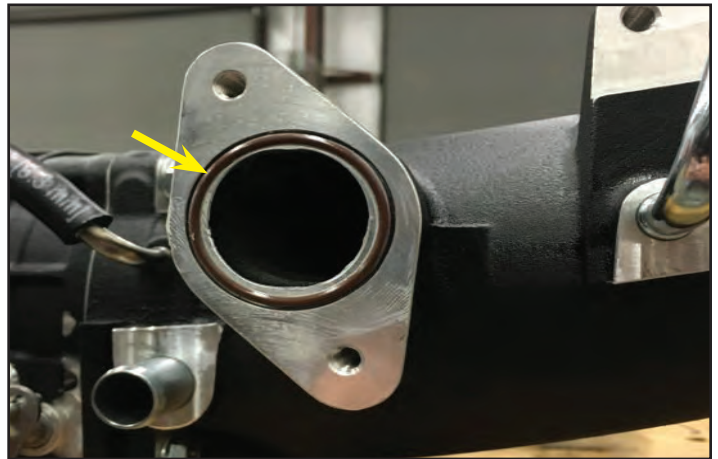

188. Use two M6x20mm bolts to install the EGR cover plate as shown.



189. Connect PCV hose to the port on the Supercharger inlet shown with a red arrow.
NOTE: Make sure the hose is routed on the outboard side of the side bracket (Green Arrow)



190. Connect the Fuel Vapor hose (5/8" OD hose) from underneath the Supercharger to the 90° tube on the supercharger inlet shown with a red arrow.



191. Remove the pushpin holding the OE brake booster hose to the side intake bracket as shown.



192. Remove the front section of hose from the check valve as shown. This hose will be replaced and can be discarded.

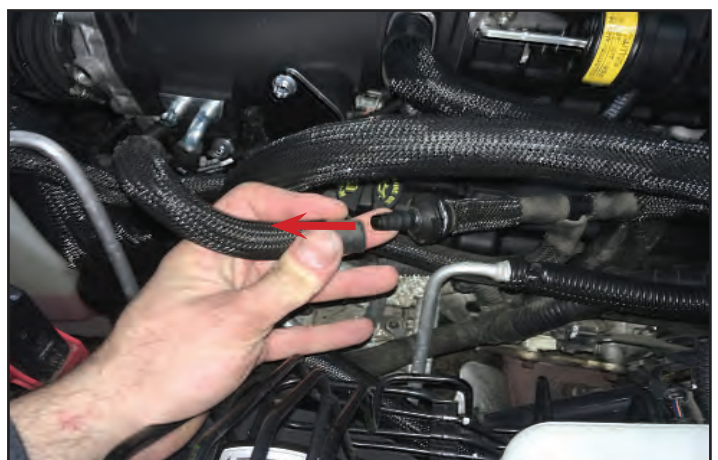

193. Install the provided extension hose as shown.



194. Make the final connection to the port on the supercharger inlet as shown.

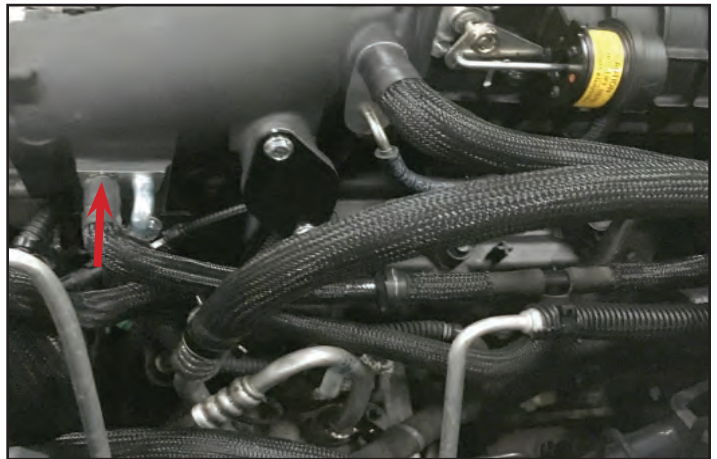

195. Remove the Supercharger pulley to allow access for the Front End Accessory Drive (FEAD) bracket mounting. Remove four M6 bolts and pull the pulley straight out to disengage the hub.



196. Collect FEAD bracket components.

- 1-FEAD Idler Bracket
- 2-Idler Pulleys
- 2-M10 x 20mm (Idler Pulleys to Bracket)
- 2-M8 x 40mm (Idler Bracket to S/C drive cover)
- 1-M8 x 50mm (Idler bracket thru Engine Front cover)
- 1-Idler bracket mount
- 1-M6 set screw

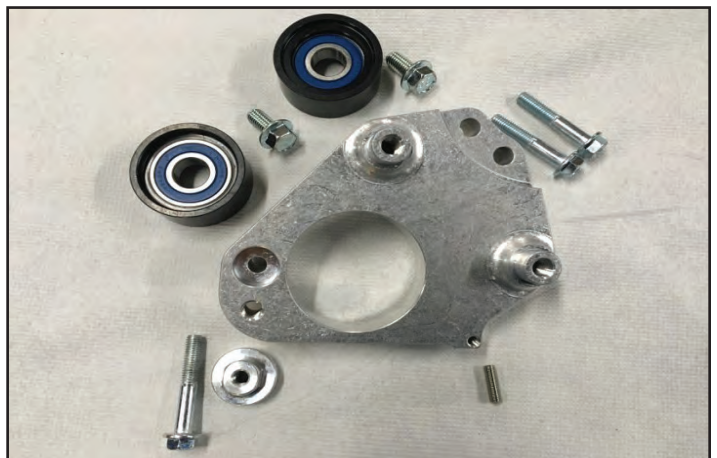

197. **Apply blue Loctite 242 to M10 bolts** and attach idlers to bracket, **torque to 18 ft-lbs.** **NOTE: Final torque is easier to apply once the bracket is installed onto the engine.**

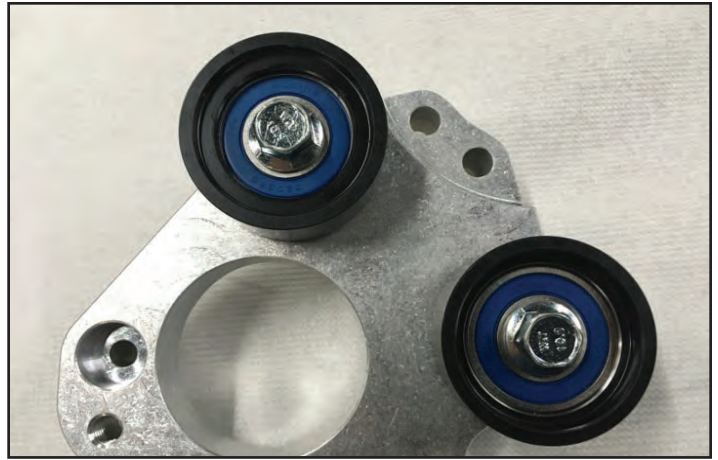

198. **Apply blue Loctite 242 to the two M8 x 40mm bolts** and install the FEAD bracket onto engine with them at the red arrow locations into Supercharger Inlet.

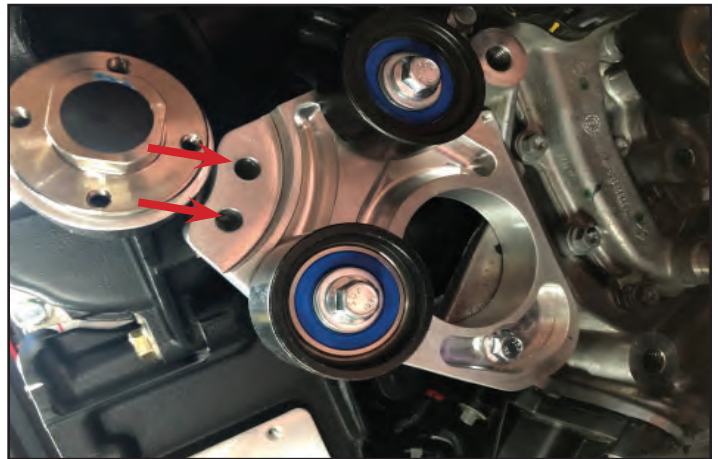

199. **Apply blue Loctite 242 to the one provided M8 x 50mm bolt** along with the FEAD mounting post shown below and at the arrow location in the photo to the right.



200. Place the FEAD Mounting Post on the backside of the front cover and thread the M8 x 50mm bolt through the bracket hole shown with the yellow arrow into the mounting post. Use a 16mm open end wrench to hold the post. **Torque the 3-M8 bolts to 18 ft-lbs.**



201. **Apply blue Loctite 242 to the supplied set screw.** Install and tighten the set screw at the arrow location. **Torque the set screw to 44 in-lbs.** **NOTE: If you have not already, apply final torque of 18ft-lbs to the M10 idler bolts.**

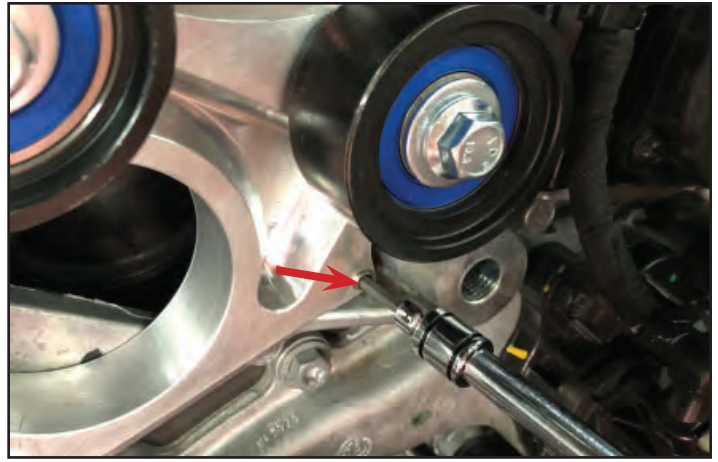

202. Install Charge Air Cooler (CAC). **Use blue Loctite 242. Install bolts and torque to 53 in-lbs.**



203. Install Turret O-ring into groove as shown.



204. Lubricate 4 O-rings on floating tubes.

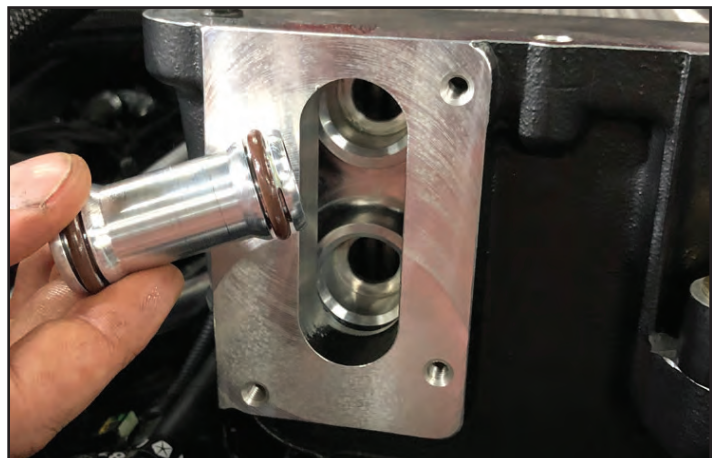

205. Once O-rings are installed on tubes press them into CAC.



206. Install turret onto floating tubes. Secure to upper intake using four M6 bolts. **Torque to 89 in-lbs.**

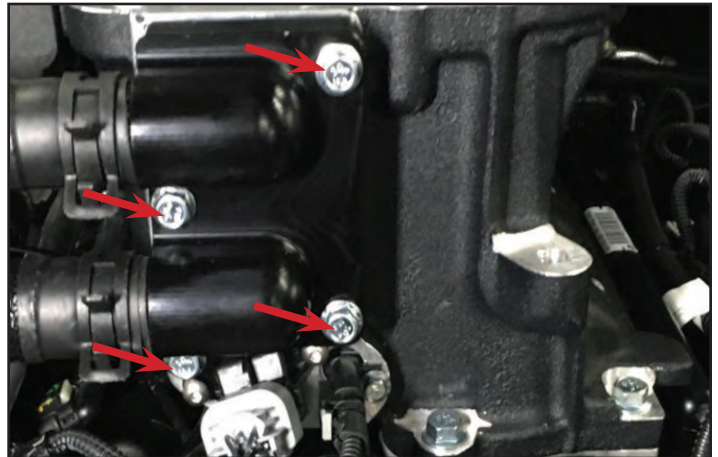

207. Remove tape from the supercharger. Clean the sealing surface of the supercharger and upper intake manifold with lacquer thinner. Ensure that there are no imperfections in the sealing surface.



208. Remove the lid from the bag and check the gaskets for any imperfections.



209. Lid fastener layout:

Three M8 X 16mm (FAUX-IN **YELLOW**)

Ten M8 x 30mm (PERIMETER-IN **RED**)

Two M8 x 45mm (FRONT CENTER-IN **GREEN**)

Two M8 X 65mm (REAR CENTER-IN **BLUE**)

There is a larger version of this at the back of this manual. **All the lid bolts will have the dished heads shown below.**

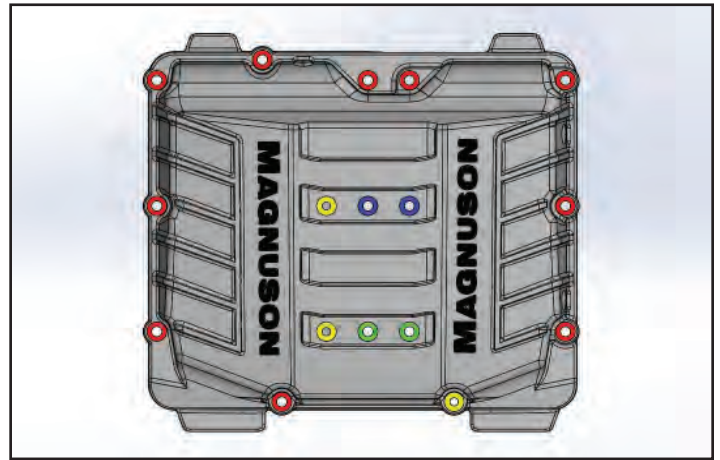

210. Apply blue Loctite 242 to all fasteners. Install lid fasteners hand tight. Then tighten both numeric (yellow) and alphabetical (red) sequence as shown in two cycles. **Tighten the first cycle, yellow and red to 8 ft-lbs. Then do another final cycle in sequence yellow and red at 18 ft-lbs.** There is a larger version of this in the back of this manual.

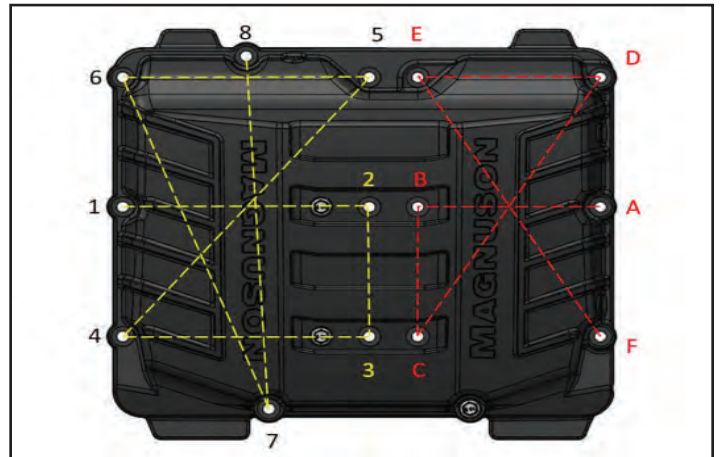

211. This Supercharger kit contains 2-extra M6x30mm bolts (only 2 bolts should be left at the end of the install shown here).



212. When installing the provided reservoir on Automatic Transmission vehicles, the rear tab (blue arrow location) needs to be removed to provide clearance for the transmission dipstick. The front tab (red arrow location) removal is optional. While installing the reservoir make sure the front tab doesn't pinch any hoses. If routed properly the front tab helps keep hoses neatly tucked against the cam cover.

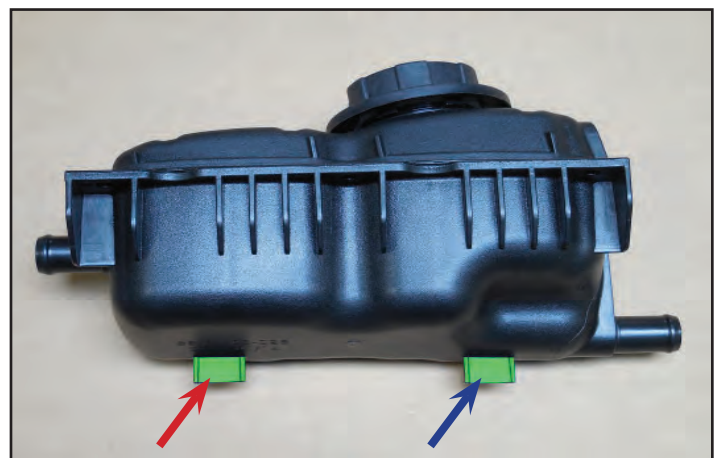

213. Drill out the three hole locations shown with arrows on the provided reservoir with a 3/8" drill bit. The top side of the reservoir is shown and this is the side that the rivet nuts will be inserted into in a later step. **Ensure that nothing gets inside of the reservoir.**



214. Deburr the tops of each drilled hole with a utility knife so the top of the flange is level.



215. Insert the three provided M5 rivet nuts into the holes that were just drilled as shown. Ensure that the upper flange of the rivet nut sits flush as shown at the arrow.

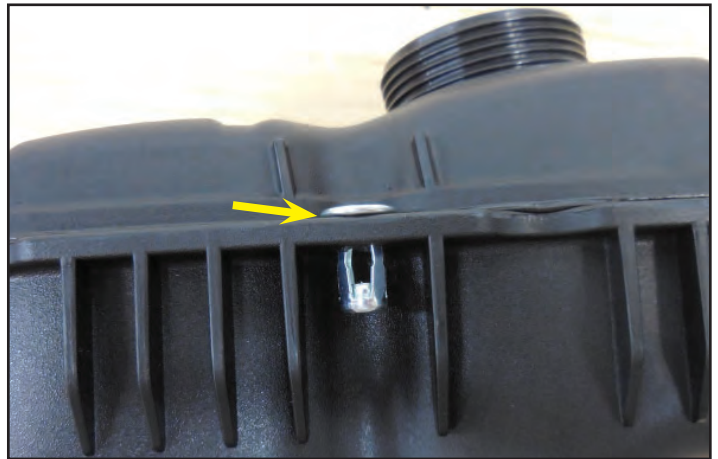

216. Install the provided M5x30mm bolt into the rivet nut and insert a small flat head screwdriver at the slot location to prevent the rivet nut from rotating. Tighten the nut to cause the slotted sleeve to expand as shown in the next step.

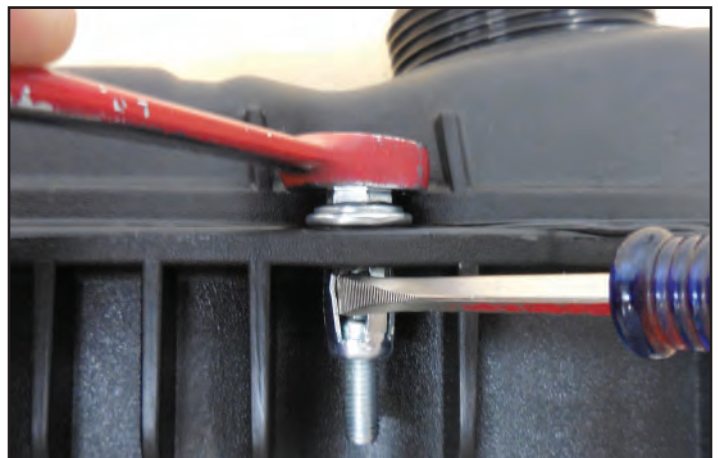

217. Continue to tighten the bolt until the overall length of the rivet nut from the top of the flange to the bottom of the nut is 0.600". Remove the M5x30mm bolt and repeat this process on the two other rivet nuts.

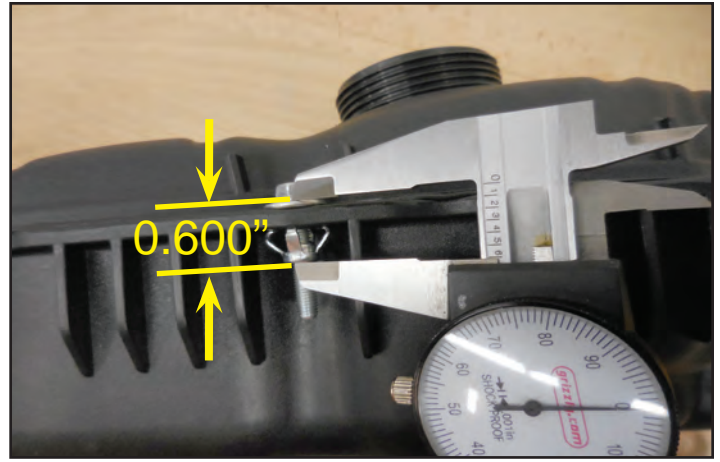

218. Find Intercooler Hose 31-19-36-011B. Using a spring clamp attach the hose to the rear port on the provided Intercooler coolant reservoir. (shown with the red arrow)



219. Attach the Intercooler Coolant Reservoir to the underside of the bosses as shown using the 3x supplied M5 x 30mm flange bolts (two locations shown here with arrows). The 3x M5 bolts run down thru the bosses on the intake and into the threaded inserts on the bottle flange as shown. **NOTE: Make sure there is clearance from the reservoir to the battery tray and from reservoir to dipstick below.**



220. Install spring clamps onto 31-19-36-011A hose, attach it to the top port on the intake manifold and the front port on the intercooler coolant reservoir (green arrows). Locate intercooler hose 31-19-36-011D which should be laying nearby from an earlier step. Attach a provided clamp to hose and connect the hose to the lower port on the intake manifold as shown. (yellow arrow).

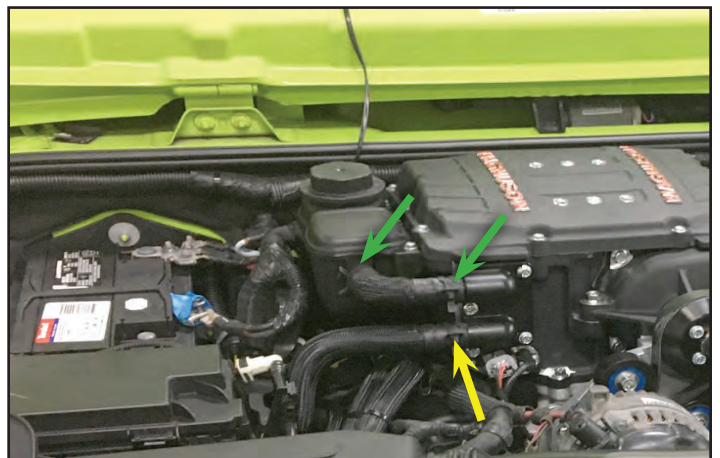

221. Reuse the OE front bracket and two M6 x 16mm bolts to attach to the engine along with two new M8X20mm to attach to the Supercharger inlet.

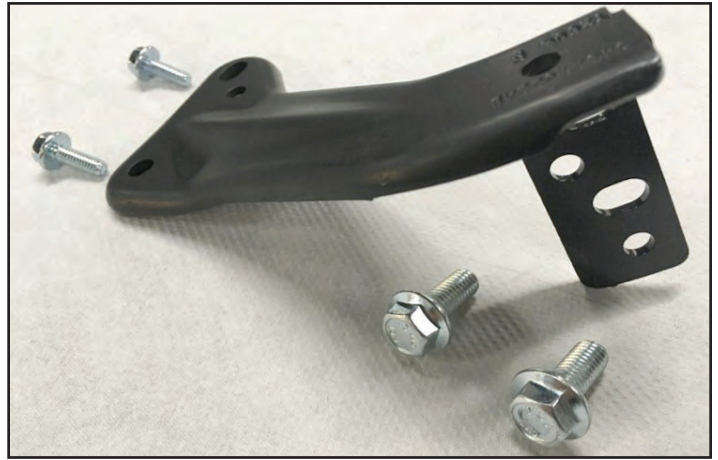

222. Highlighted in green here is the bracket from the last step located under the throttle body with four supplied bolts. **Torque the M6 x 16mm bolts to 89 in-lbs (yellow arrows), and M8 x 20mm bolts to 15 ft-lbs (red arrows).**

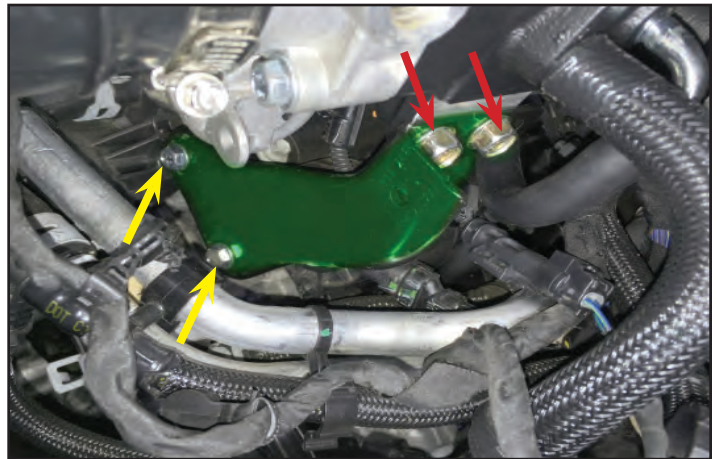

223. Install the OEM throttle body gasket that was removed earlier (shown below) into the supercharger inlet groove (arrow location) prior to installing the throttle body.



224. Install the OEM throttle body with the provided bolts. **Torque these bolts to 106 in-lbs.**



225. Apply blue Loctite 242 to the four M6x16mm bolts and reinstall the pulley. Torque these bolts to 106 in-lbs. (Note: This will be easier to tighten once the belt is on.)



226. Install the alternator reusing the OE hardware. Make sure to properly route the belt over the alternator pulley. Then reconnect the electrical connector and ground wire with cover.



227. Make sure the belt route is correct on all pulleys except water pump. Torque the tensioner to loosen the belt and carefully slip the belt back over the water pump pulley. Once the system is correctly routed and under tension, **tighten the four supercharger pulley bolts to 106 in-lbs.** There is a larger version of this diagram at the back of this manual. (Supercharger Belt = Gates# K061005)

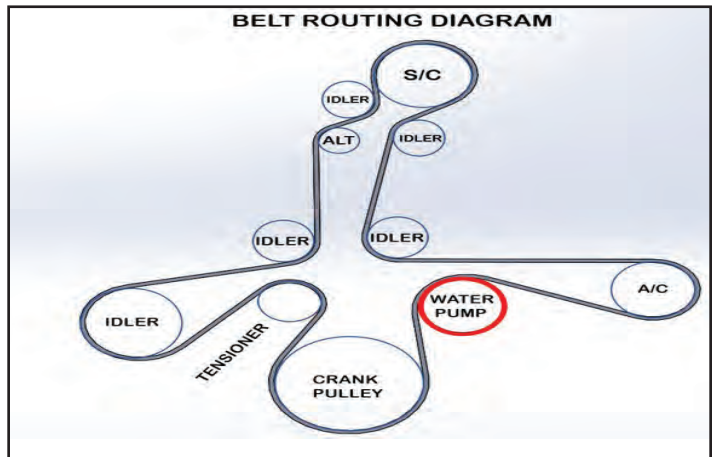

228. Align the three pins on the bottom of the air box with the three grommets on the air box tray and press the air box back in original position. This will "snap" in place.



229. Connect the OEM air tube to the throttle body and air box and secure with the OEM clamps.



230. Secure the air tube in place with the two original mounting bolts and tighten using a 10mm wrench.

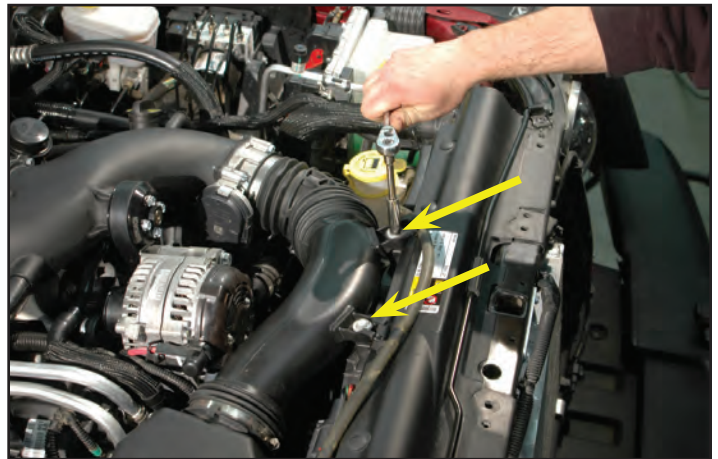

231. Press the overflow hose back on the two clamps by the mounting bolts of the air tube.

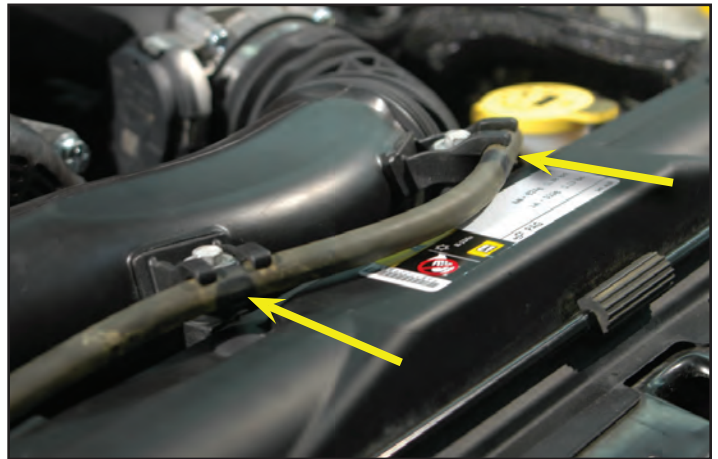

232. Reinstall the grille-fascia on the vehicle aligning the mounting tabs on the bottom and press into position.



233. Reinstall the six push pin rivets in the top of the grill-fascia by pressing the rivet in place and then pushing the locking pin down.



234. Reconnect the right and left hand side turn signal plugs.



235. Cut 1-1/2" off the end of the PCV hose on the right hand side of the engine and reconnect to the air box hose barb.

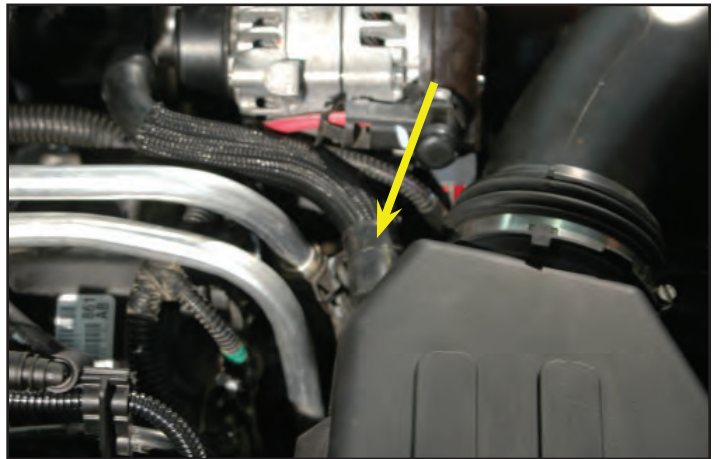

236. **For 2015-2018 Jeep JK only.** Once you have received the PCM back from getting unlocked you will reinstall the bolts at the red arrows. **VERY IMPORTANT: Be sure to re-attach the PCM ground strap between the PCM and the bracket when installing the front bolt.** Plug the connections in for the PCM and secure the two clamps at the yellow arrows.



237. Reconnect the battery negative terminal and secure with 10mm wrench.



Make sure that you have followed the steps at the beginning of this manual to load the proper Supercharger calibration to your vehicle's ECM.

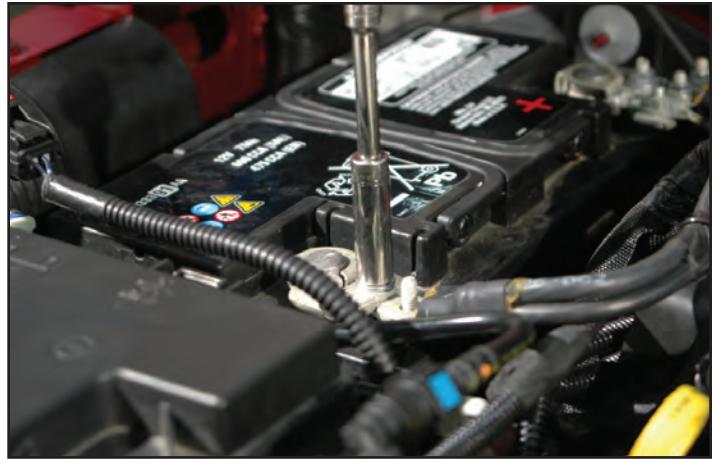

238. Reconnect the window washing tube to the mounting clip and set your hood back on the hood prop.



*****WARNING: You must perform a vacuum leak down test on your intercooler system prior to adding any coolant. This can be accomplished with the same equipment that is used for engine cooling systems.*****

239. **Ensure that the radiator petcock is closed.** Refill coolant system per Jeep Manual. Fill Supercharger Intercooler system with coolant at the reservoir using the same type of coolant that is recommended for your engine coolant system following the steps starting on the next page..



Section 13: Intercooler System Filling and Air Removal

240. **If air is present in the system, the intercooler pump will automatically shut off leading to excessively high intake air temperatures which can cause engine damage. Therefore we highly recommend using a cooling system vacuum purge and refill kit as shown here to properly fill the system.**

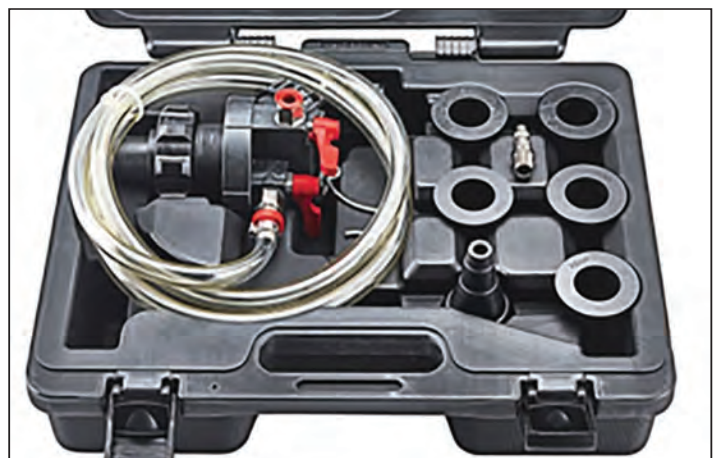

241. Remove the cap from the degas bottle and using the correct adapter, connect the "Evac" tool to the filler neck.



242. Connect the shop air to the tool, and submerge the fill hose into the fill coolant container.



243. Pull a partial vacuum on the system and close the vacuum line.



244. Slowly open the fill valve and purge all the air out of the fill hose to avoid any air being introduced during the fill process, and once the coolant gets to the valve close it.



245. Pull a vacuum until all of the air is out of the system. All of the intercooler system hoses will be fully collapsed and the needle will stop rising. Close the vacuum valve and let the system sit for a few minutes and make sure the vacuum holds. This will help insure that the system has no leaks. **If the gauge loses vacuum, YOU HAVE A LEAK somewhere in the system.** This leak must be found and repaired as it could be a rolled O-Ring on the extension tubes from the coolant manifold to the CAC. (Charge Air Cooler) If an O-Ring is leaking then the coolant from this system can leak into the engine and cause damage.



246. Once all the vacuum is gone, remove the tool from the tank, but do not install the cap yet. At this point start the engine and make sure the coolant is flowing vigorously through the bottle. (The pump takes a few seconds to ramp up so be patient). Once the coolant is flowing, shut the engine off and let the coolant settle. Once the coolant has settled, fill the bottle so that the level is just above the inlet to the tank.



247. If you are unable to use a vacuum purge and refill kit you can follow the directions in the next step to fill your system manually.

248. Option #2: Manual filling.

- a. Using a coolant funnel attach the correct adaptor to the intercooler reservoir.
- b. Connect the funnel to the adaptor.
- c. Fill the funnel to the $\frac{1}{2}$ way mark with a 50/50 mixture of the same coolant approved by the OEM. If you don't have the funnel shown make sure the reservoir tank is full.
- d. Remove the trigger wire from the fuse in the fuse box and touch it directly to a 12 volt source. While the pump runs you need to massage the hose to try and force the air up out of the system. Repeat touching the trigger wire to the 12v source for the duration of the pump running.
- e. As the level drops in the tank, make sure that you pause and refill the tank to prevent any air from getting back into the system.
- f. Once coolant starts flowing keep the trigger wire to the 12V supply, add coolant as needed until the coolant flows consistently.
- g. Remove the trigger wire from the 12v source. Fill the tank back up to above the inlet port to the tank, put the cap on, and re-connect the trigger wire to the fuse in the fuse box.
- h. Start the vehicle and verify the intercooler system is running.



249. Start the vehicle for 5 seconds and shut it off. Check for fuel leaks and supercharger belt alignment. Check the intercooler reservoir level. Now start your engine and let it run for a few minutes to let it get to operating conditions. Let the engine cool down, and check all your levels again.



250. Test drive vehicle for the first few miles under normal driving conditions. **Do not perform any wide open throttle runs.** Listen for any noises, vibrations, engine misfire or anything that does not seem normal. The supercharger does have a slight whining noise under boost conditions, which is normal. Check and top off the intercooler reservoir as needed.



251. After the initial test drive gradually work the vehicle to wide open throttle runs, listen for any engine detonation (pinging). If engine detonation is present let up on the throttle immediately. Most detonation causes are low octane gasoline still in the tank.

If you have questions about your vehicles performance, please check with your installation facility.

After you finish your installation and road test your vehicle, please fill out the warranty registration. This can be found on our website.



Oil Filter and Fill Cap Removal Information

252. The next few steps show the process for accessing and removing the Oil Cap and Oil Filter Cap, as the supercharger kit reduces clearance in these areas. The remainder of the oil changing process is unaffected and will remain the same as OEM process. Parts and tools needed to replace Oil Filter are shown here.



253. To remove the cap and access the Oil Filter you will need a 24mm socket and extension as shown.

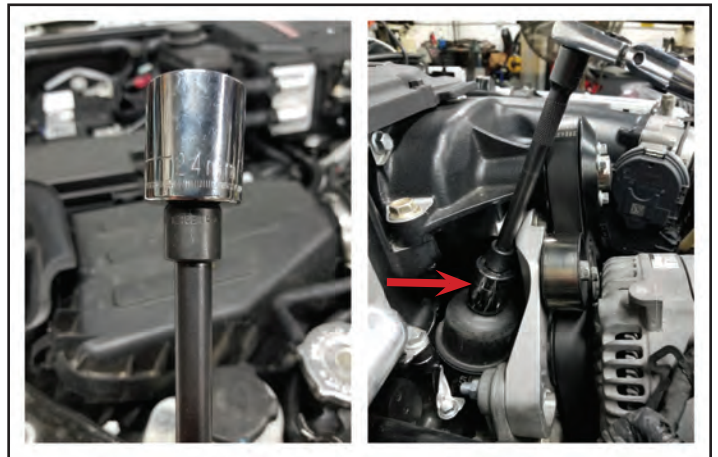

254. Once the cap is loose pull up to remove, it is normal for the cap to disconnect from the filter during this process.

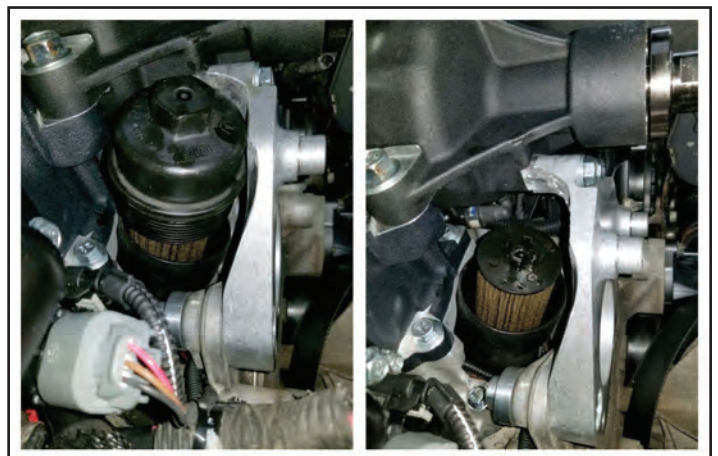

255. Carefully remove and discard used oil filter.

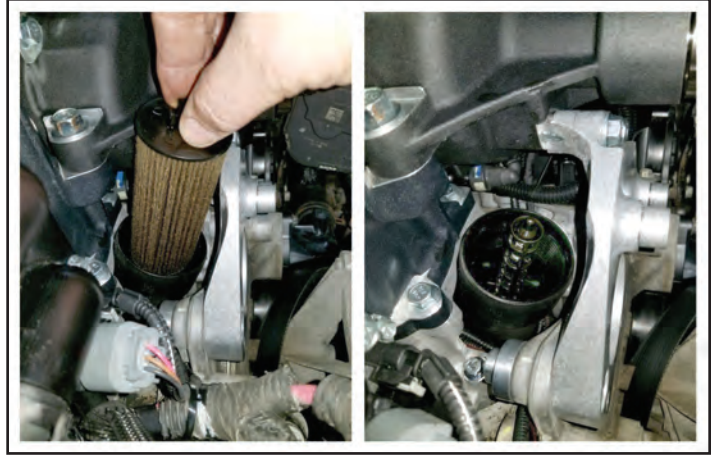

256. Assemble the new filter and O-ring to the OEM Oil Filter Cap and re-install as shown.

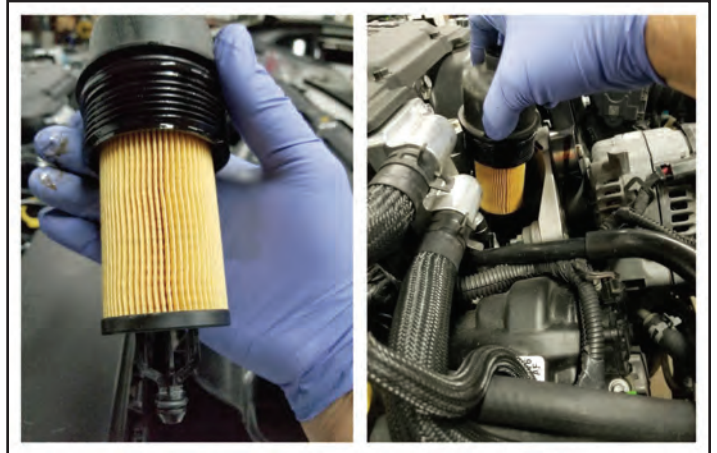

257. Use a torque wrench to tighten to 18 ft-lbs.



258. Oil Fill Cap and fill funnel location: Jeep JK

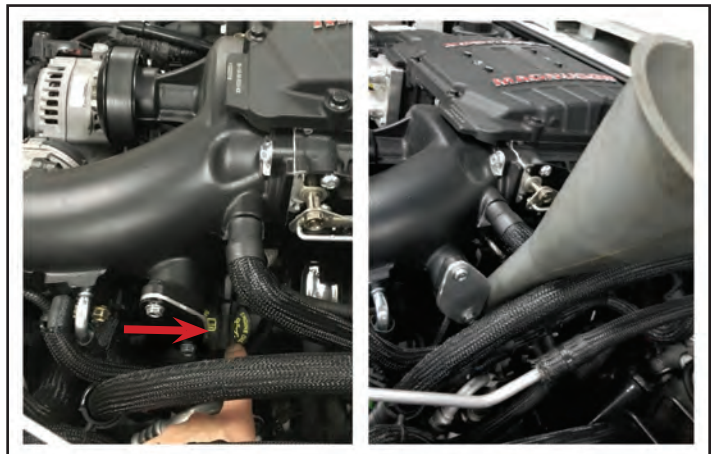

APPENDIX

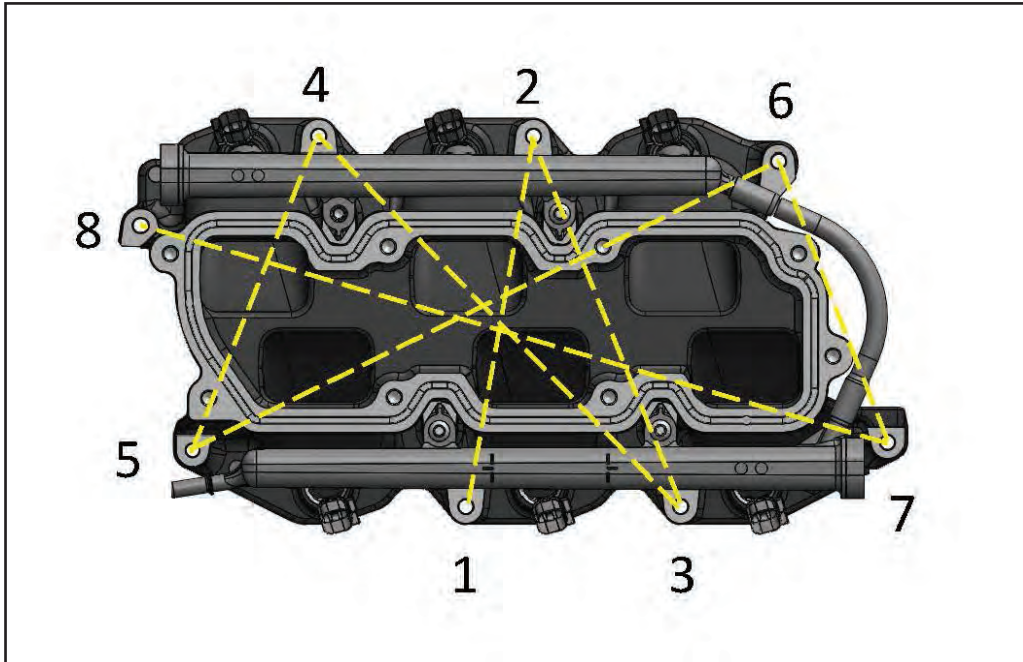

Torque Sequence for Lower Intake Manifold (106 in-lbs)

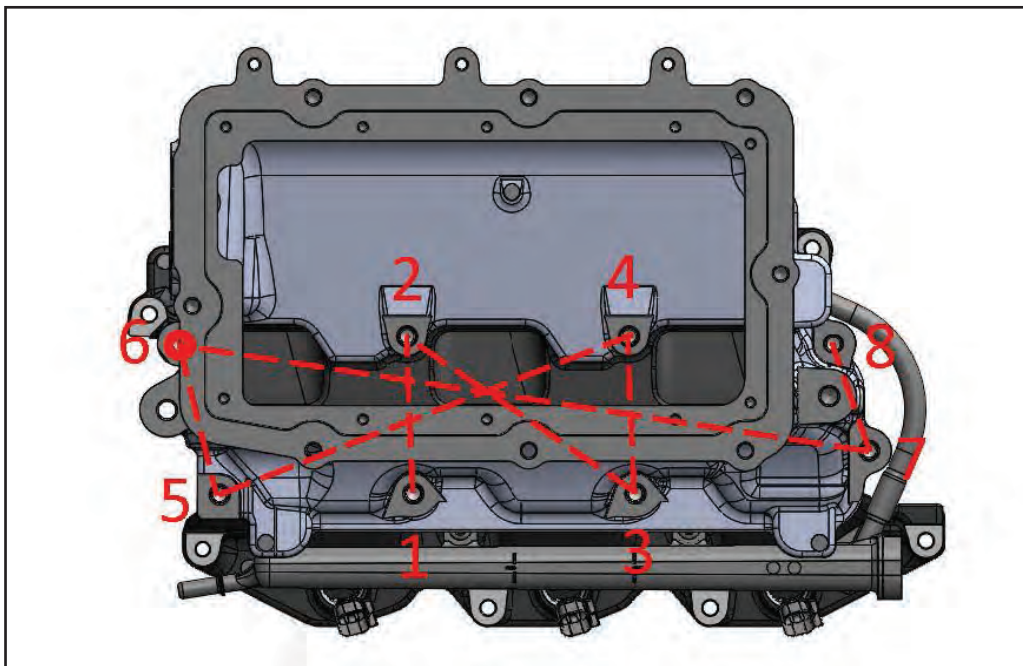

Torque Sequence for Upper Intake Manifold (18 ft-lbs)

APPENDIX

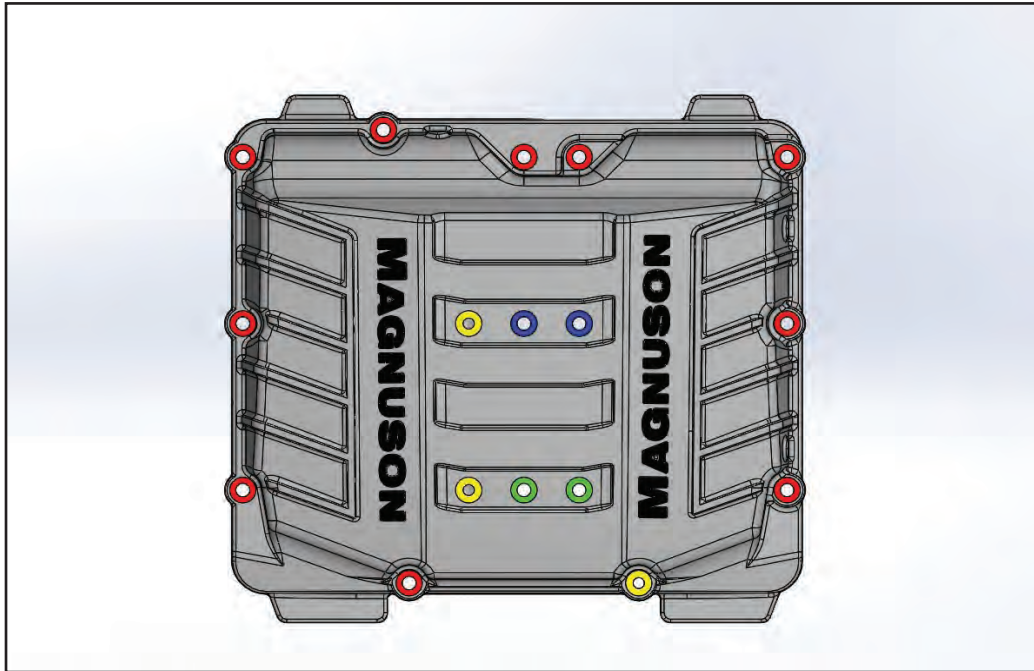

Lid fastener layout:

Three M8 X 16mm (FAUX-IN **YELLOW**)

Ten M8 x 30mm (PERIMETER-IN **RED**)

Two M8 x 45mm (FRONT CENTER-IN **GREEN**)

Two M8 X 65mm (REAR CENTER-IN **BLUE**)

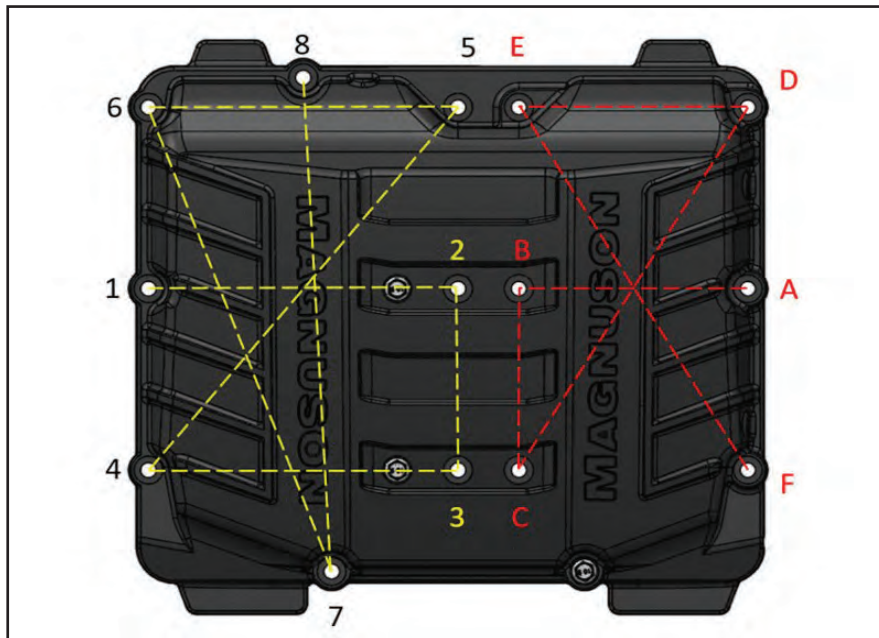

Torque Sequence for Lid (18 ft-lbs)

APPENDIX

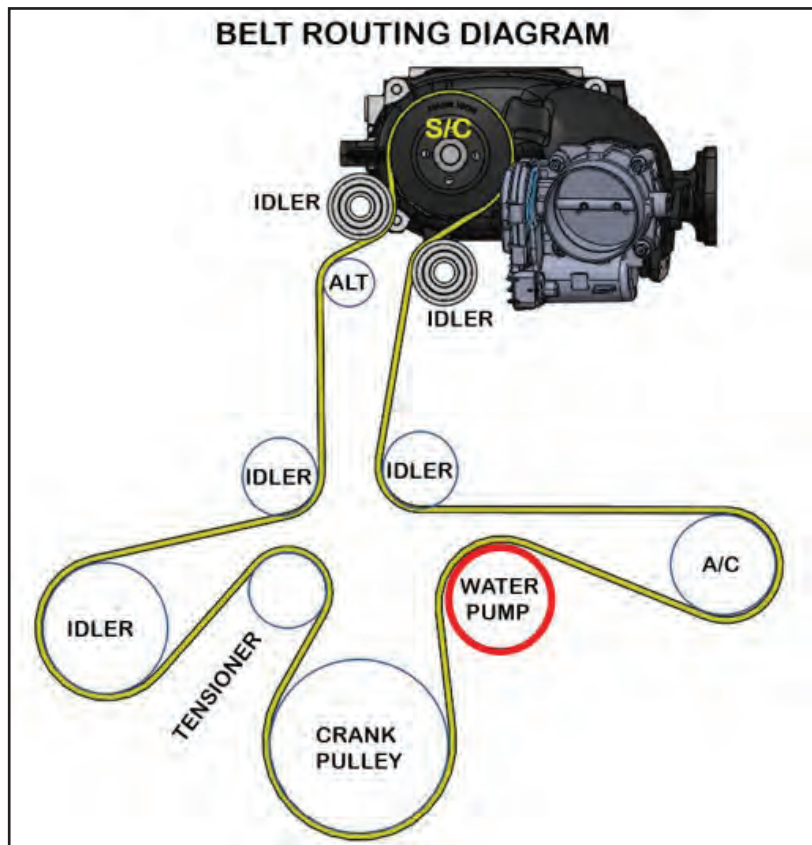
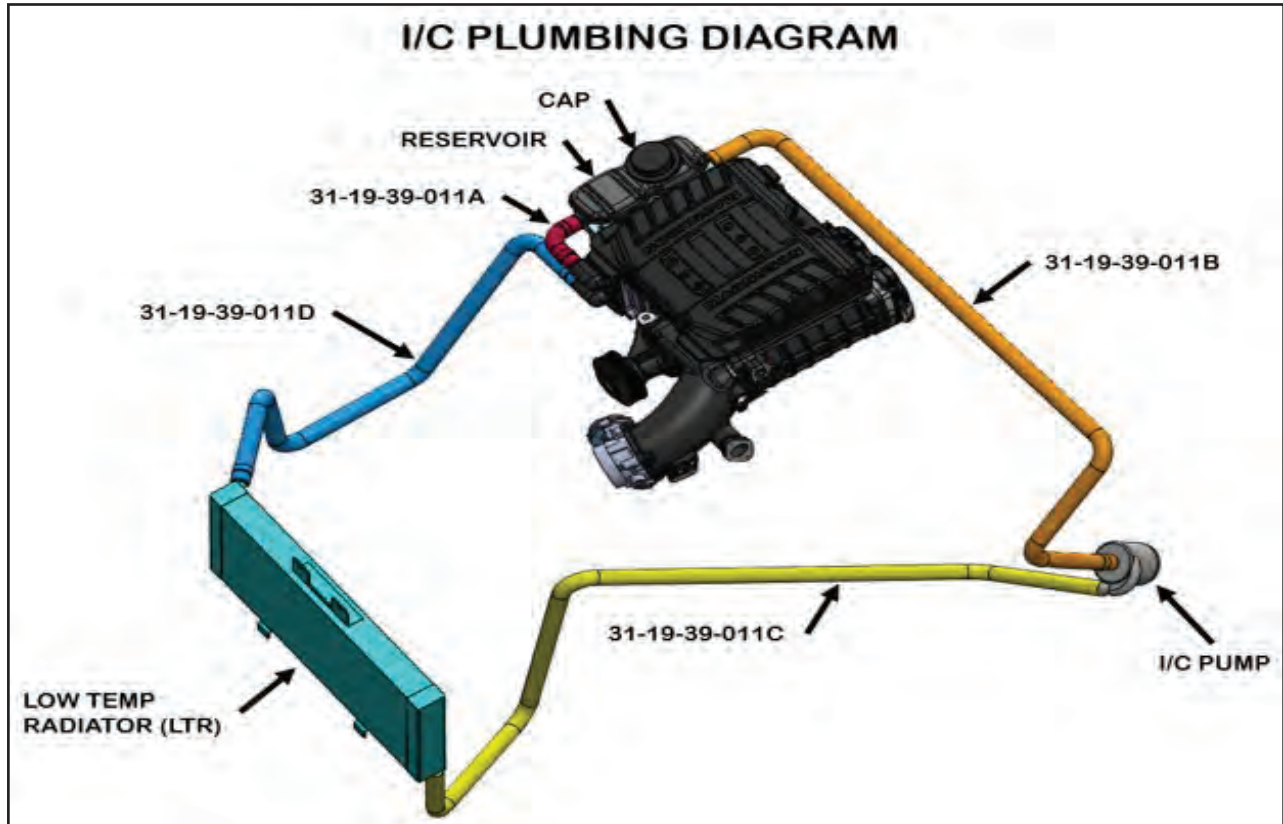

Supercharger Belt = Gates# K061005

APPENDIX

VACUUM ROUTING DIAGRAM

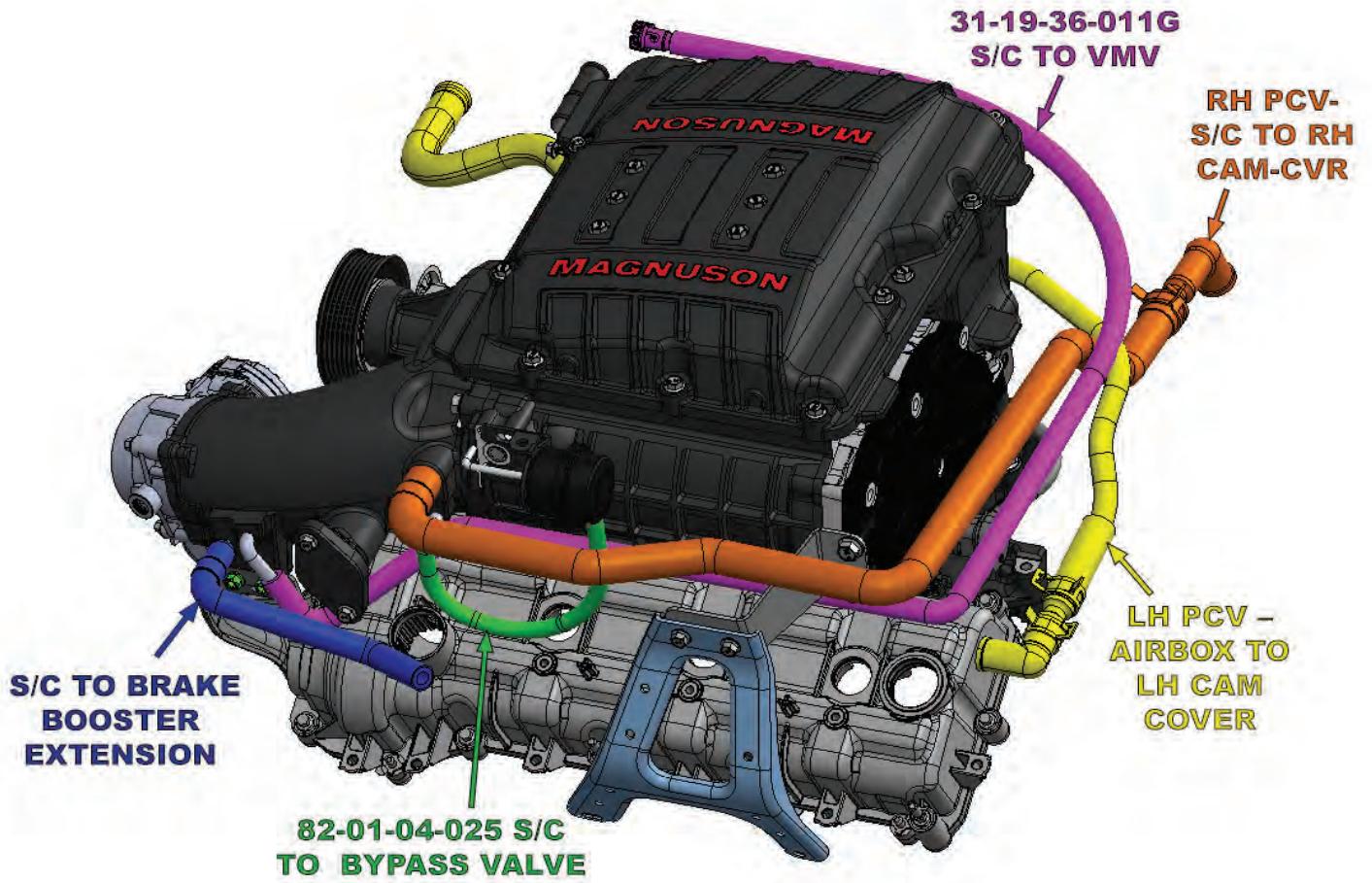

APPENDIX

TEMPLATE - I/C PUMP BRACKET DRILL GUIDE- JEEP JK

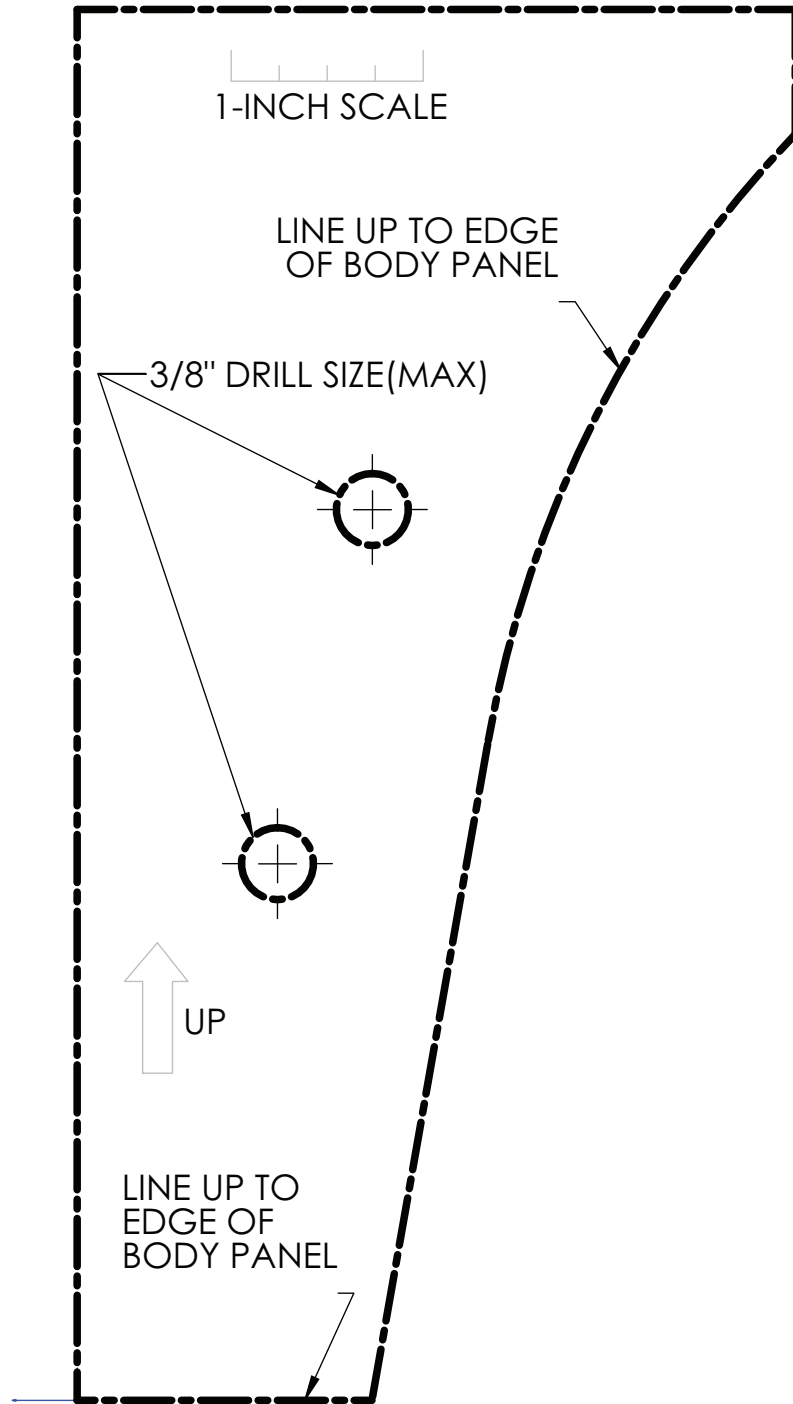

NOTES



Please enjoy your "Magnuson SuperCharged" performance responsibly.

*** PREMIUM 91 OCTANE GASOLINE FUEL REQUIRED ***

MAGNUSON
SUPERCHARGERS