

Installation Instructions

Eibach Springs, Inc. • 264 Mariah Circle • Corona, California 92879-1751 • USA • Tech Support 800-222-8811 Ext 114

Pro-Truck Sport Leveling – # E60-27-001-04-10

Note: The OEM spring perch will have to be removed from the OEM strut assembly and installed onto the Eibach Pro Truck Sport Damper

Note: The average lift amounts shown on page 3 of this instruction sheet are based on using the OE springs. If using the Eibach Pro Lift springs, refer to the instructions that are specific to the Eibach Pro Lift springs.

Note: Eibach recommends replacing used snap rings with new snap rings when adjusting the ride height on your truck. We have included a spare snap ring for such occasions.

Contents	Description	Part Number	Qty
	Damper Assy.	28119.8003.1	1
	External Snap Ring	84-1804	1
	Bump Stop Cap	8000795	1
	Rod Wiper	8000796	1
	Nut, Nylock M12-1.25	H63075400	1
	Spring Perch Adapter	8001419	1
	Installation Instructions	28119.8003INST	1
	Snap Ring kit, Spare	84-1804.0	1

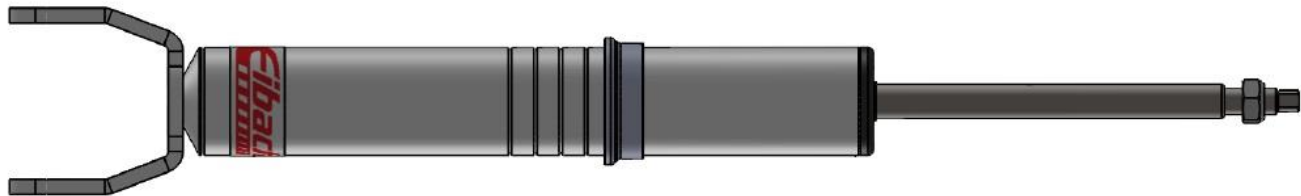

NOTES: Read All Instructions Before Beginning Installation

1. Park vehicle on level surface and set emergency brake. Raise and support the vehicle with safety stands. Refer to factory manual for proper location of safety stands.
2. Power washing your chassis will make the installation cleaner.
 - **NOTE:** Never work on or under a vehicle unless it is properly supported by safety stands.
3. Loosen and remove the OE shock per the factory recommended removal procedure.
4. Installation of the Eibach Pro Damper shock should be done in the reverse order of removal.



Shock Instructions and Safety Tips

Installation

IMPORTANT NOTES:

- Any time you are working under a vehicle, be sure to use the proper jack stands and tire chocks to prevent any shifting or slipping of the car. Never use a jack only to support the vehicle while changing shocks.
- Inspect shock brackets or mounting points before installation to make sure they are not broken or bent.
- Do not attempt to disassemble these shocks. Return damaged shocks to EIBACH SPRINGS for any necessary service or repairs.

PLEASE READ THESE INSTRUCTIONS ENTIRELY BEFORE BEGINNING

- Proper installation is a must to realize the maximum performance improvements. Follow these steps carefully.

USE THE RIGHT SHOCK FOR YOUR VEHICLE

- Use EIBACH SPRINGS shocks only for the applications for which they are listed. Each shock is specifically tuned for that vehicle's weight, suspension geometry, and other characteristics.
- Compare original shock mounting style and hardware with your new shocks before starting installation. If original hardware is not reusable, it should be replaced with OEM quality and style hardware.
- Shocks are tuned to vehicle manufacturer's recommendation for tire pressure, not necessarily the max inflation pressure listed on sidewall of tire.

IMPORTANT INSTALLATION NOTES

- If you are uncertain of proper shock installation procedure, please consult appropriate service manual. Torque all fasteners to vehicle manufacturer's specs. Note: On Post Mount shocks, finger tighten nut to achieve zero clearance between the retaining washers and the bushings, then continue to tighten approximately 5-6 turns to achieve proper pre-load. Bushings should be slightly bulged. Secure with Jam Nut. On some vehicles, nut may bottom out on stud before 5-6 turns, which is proper for those applications.
- OEM mounting hardware may be either standard or metric. Make sure you have the proper tools before starting. Do not interchange hardware. Use new mounting hardware provided with your shocks, and re-use original mounting hardware in all other locations.
- EIBACH SPRINGS shocks have a high-pressure nitrogen gas charge and may come with a restraining strap, which holds the shock in a compressed position. To ease most installations, leave the strap on until you have secured one end of the shock, then cut the strap and quickly guide the other end of the shock into position as it expands. Strap must be cut before some installations, such as when strap goes around post.
- Wire ties are provided to secure the shock boot to the shock body. On some installations (especially where the shock must pass through a hole in the lower control arm), it is necessary to put the wire tie on after the shock is installed.
- After installing shocks and before driving vehicle, check for clearance of exhaust, brake or gas lines, electrical wiring, etc.
- After installation, drive the vehicle cautiously for the first few miles to develop a feel for the improved handling and ride quality. After 10 miles, inspect installation, re-check torque on all fasteners, and verify adequate component clearance.

Note: If using the Eibach Pro Lift springs, refer to the instructions for the springs to determine the proper perch height. The average lift shown below is based on using the OE springs.

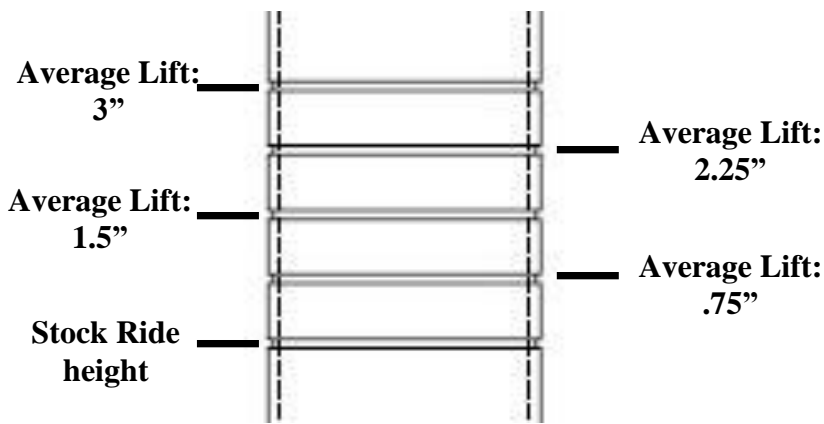

Important: Ensure that the Snap Ring is fully seated in the snap ring groove (you should be able to rotate it manually). Install the Spring Perch Adapter in the orientation shown, making sure the snap ring is fully seated into the groove on the bottom side of the spring perch adapter. **Note: Improper installation will cause permanent damage to the shock.**

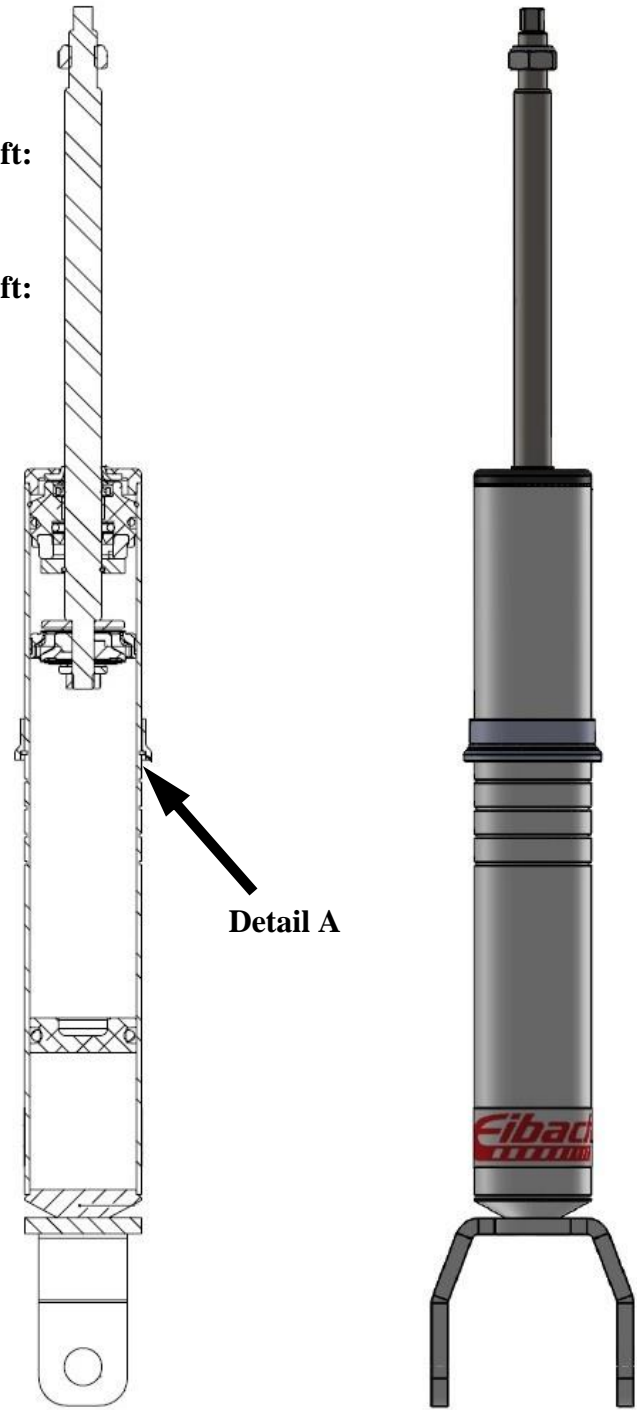

Detail A

